

5

4

3

2

1

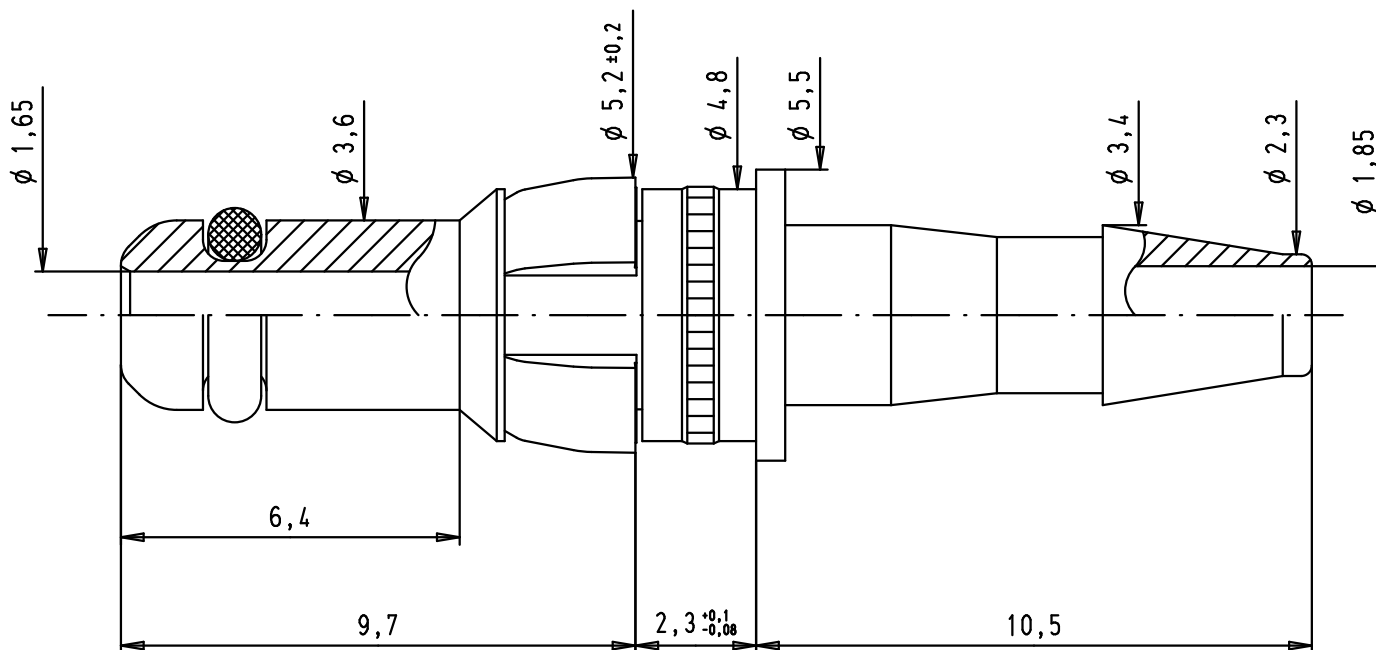
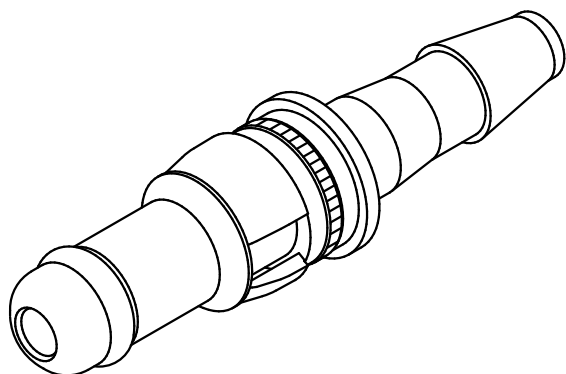



D

C

B

A

				Dot.	Name	 All Dim. in mm Orig. Size DIN A 4	Straight male pneumatic contact for 3 mm inner diameter compressed air tube	Maßstab/ Scale 7:1
			Detail.	25/04/07	PK			
			Insp.					
			Stand.					
33985	25/04/07	PK	HARTING EURL F-95972 Paris				TB 09 69 287 0062	Blatt/ Page 1 / 1
Mod.	Dot.	Name	Sub.					