

Reduce inventory levels and cost by stocking actuators and base switches separately.

**Contura II, III, IV, V, X, XI, XII Base switches separately:** specify V with code selections 2-8 in the ordering schemes.

**Contura II, III, IV, V Actuator only:** VV with code A or C for selection 9, & with selections 10-14 in the ordering schemes.

**Panel Seal:** VPS

**Contura II, III, IV, V Actuator only:** VV with code A, C, E, G or P for selection 9 & with selections 10-14 in the ordering schemes.

**Contura X, XI, XII actuators with lenses separately:** VV with code selections 9-14 in the ordering schemes.

### Contura X & XI actuators without lenses separately:

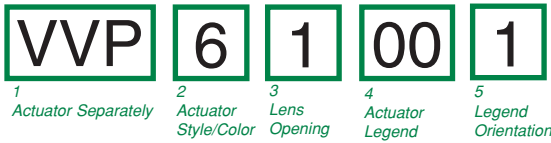

<b>1 CONTURA X &amp; XI ACTUATOR SEPARATELY</b> VVP									
<b>2 ACTUATOR STYLE &amp; COLOR</b>									
	Black	Gray	White	Red					
Contura X	1	2	3	4					
Contura XI	6	7	8	9					
<b>3 LENS OPENING FOR<sup>1</sup></b>									
1	One bar lens	4	Two Square lens						
2	One bar lenses	5	Square lens on top/ bar lens on bottom (Contura X only)						
3	One Square lens								
<b>4 ACTUATOR LENS OR BODY LEGEND</b>									
00 - No Legend this location									
11	ON	12	OFF	13		14	O		
	OFF		ON		O				
15	O	16	O	17	O		18		O
	F	N	F		N	F			
For additional legend options & codes, see page 69 of this catalog									
<b>5 LEGEND ORIENTATION<sup>2</sup></b>									
0	No legend								
1	Orientation 1								
2	Orientation 2								
3	Orientation 3								
4	Orientation 4								

### Contura X, XI & XII top piece of 2-piece lens separately:

<b>1 TOP OF LENS SEPARATELY</b> VVT					
<b>2 COLOR</b>					
1	Clear	2	Smoke	3	White

### Contura X, XI & XII actuator lens assembly:

1 piece lens/bar lens are positioned the same as bottom lens for assembly, minus the top lens. Lenses snap in from bottom.

- NOTES
- 1 If actuator lens opening for 2 bar or 2 square lenses, legend orientation 0, 1, or 2 must be chosen.
  - 2 Center of actuator marking not available for Contura XII.
  - 3 Legend is not available for bar style lens.
  - 4 Not recommended with neon lamps.
  - 5 Must also order top piece of 2 piece square lens separately.

### Contura XII actuators without lenses separately:

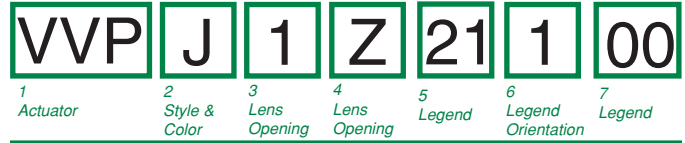

<b>1 CONTURA XII ACTUATOR SEPARATELY</b> VVP										
<b>2 ACTUATOR STYLE &amp; COLOR</b>										
J	Black	K	Gray	N	White	M	Red			
<b>3,4 LENS OPENING FOR</b>										
Z	No lens	1	Bar lens	2	Square lens					
<b>5, 7 LENS OR BODY LEGEND<sup>2</sup></b>										
00	no legend	21	OFF	22	ON	23	O	24		
25	O	26	O	27	O	28				
	F		N		F					
For additional legend options & codes, see page 69 of this catalog.										
<b>6 LEGEND ORIENTATION<sup>3</sup></b>										
0	No legend									
1	Orientation 1									
2	Orientation 2									

### Contura X, XI & XII actuator lens assembly separately:

<b>1 CONTURA X, XI &amp; XII LENS SEPARATELY</b> VVL											
<b>2 LENS STYLE<sup>3</sup></b>											
1	Bar lens	2	One Piece Square lens	3	Bottom of Two-Piece Square lens <sup>5</sup>						
<b>3 TRANSLUCENT LENS COLOR</b>											
1	Clear	2	White	3	Amber	4	Green <sup>4</sup>	5	Red	6	Blue <sup>4</sup>
<b>4 LENS OR BODY LEGEND<sup>2</sup></b>											
00	No legend										
21	OFF	22	ON	23	O	24					
25	O	26	O	27	O	28					
	F		N		F						
For additional legend options & codes, see page 69 of this catalog.											
<b>5 LEGEND ORIENTATION<sup>3</sup></b>											
0	No legend										
1	Orientation 1										
2	Orientation 2										
3	Orientation 3										
4	Orientation 4										

## Easily integrate Contura products into your system, with Contura Accessories

### Contura Connectors

Q.C. SELECTION GUIDE					
COMPANY SERIES	PART NO		WIRE RANGE		ORIENTATION
	PLAIN BRASS	TIN PLATED BRASS	AWG	MM (REF)	
PACKARD 58 SERIES	02965580		12	3.0	B
	02965471	12010601	(2)16-14	(2)1.0-2.0	
	02965470		16-14	1.0-2.0	
	02965469	06288318	20-18	.5-.8	
PACKARD METRI-PACK 630 SERIES		12084590	12	3.0	A
		12052224	12	3.0	
		12015870	16-14	1.0-2.0	
		12020035	(2)22-18	(2).5-.8	
	12015832	12015869	20-18	.5-.8	
		12052222	20-22	.35-.5	
AMP 250 SERIES FASTIN-FASTON	60253-1	60253-2	16-12 (2) 16	1.3-3 (2) 1.3	B
	42100-1	42100-2	18-14	.8-2	
	60295-1	60295-2	22-18	.3-.9	

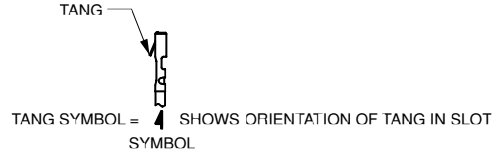

**NOTE:** Consult Delphi Packard and/or Amp or actual part numbers and availability.  
 AMP is a registered trademark of AMP Inc. Harrisburg, PA  
 Delphi Packard is a registered trademark of Delphi-Packard Electrical Systems Warren, Ohio

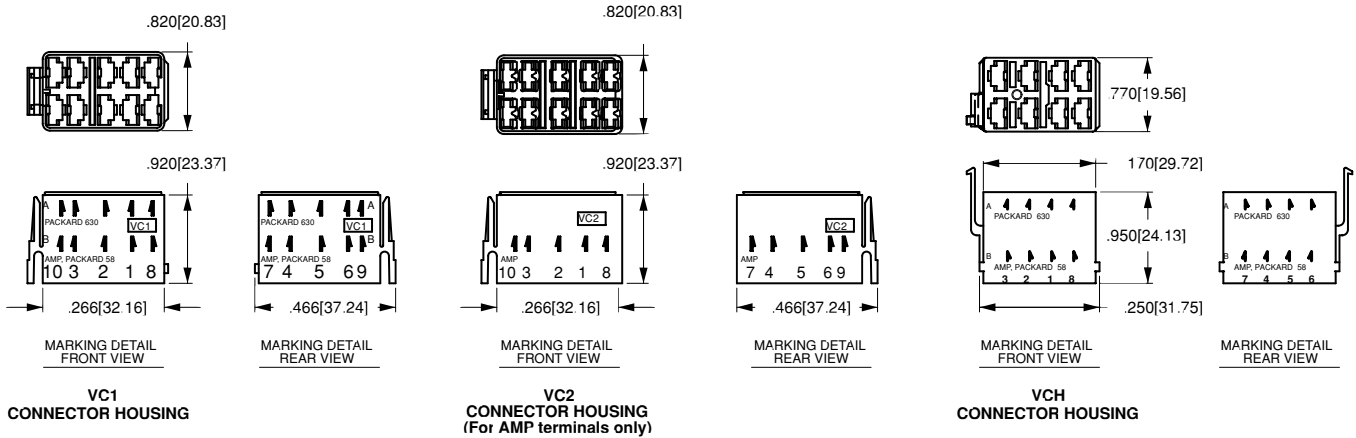

### Contura X Boot

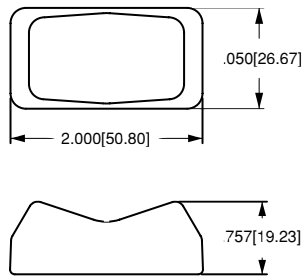

VB1-01  
CONTURA X BOOT

### Contura II, III, IV & V Actuator Removal Tool

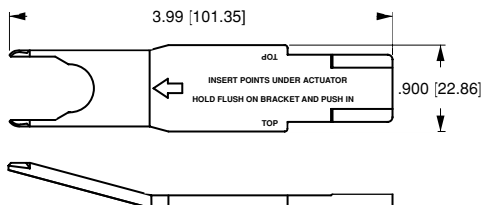

VRT  
ACTUATOR REMOVAL  
TOOL  
(For flush bracket)



## Contura Mounting Panels

### Dimensional Specifications: in. [mm]

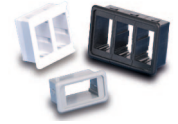
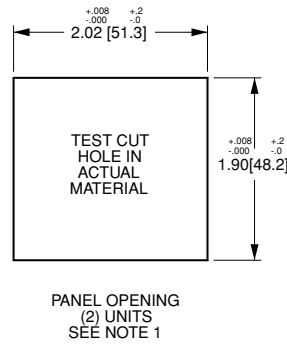
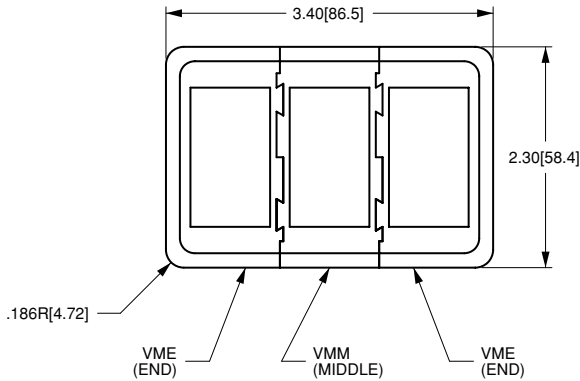

PANEL THICKNESS:  
TOLERANCE:

.062[1.57]  
.093[2.36]  
.125[3.17]  
.187[4.75]  
.250[6.35]  
.375[9.52]

**NOTES:**

1. FOR ADDITIONAL UNITS, ADD 1.03 [26.2] PER UNIT.
2. FOR MORE THAN 2 V-SERIES SWITCHES, ADD MIDDLE SECTION.

## Contura Hole Plug

### Dimensional Specifications; in. [mm]

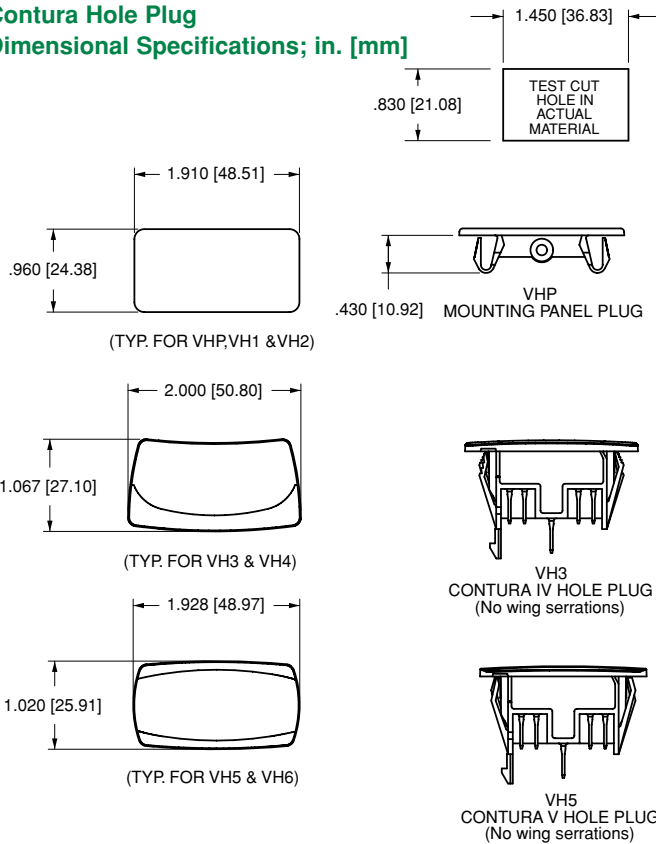

VHP MOUNTING PANEL PLUG

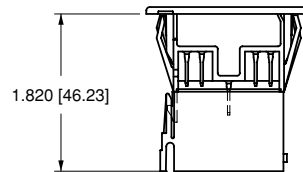

VH1 STANDARD HOLE PLUG  
(No wing serrations)  
(With VC1 connector attached)

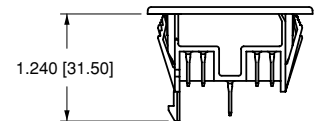

VH2 STANDARD HOLE PLUG  
(With wing serrations)

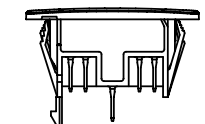

VH3 CONTURA IV HOLE PLUG  
(No wing serrations)

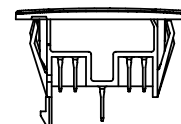

VH4 CONTURA IV HOLE PLUG  
(With wing serrations)



DETAIL VIEW  
VH1, VH3 & VH5 HOLE PLUGS  
(No wing serrations for ease of removal)

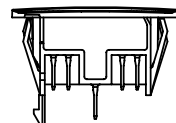

VH5 CONTURA V HOLE PLUG  
(No wing serrations)

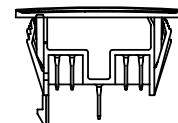

VH6 CONTURA V HOLE PLUG  
(With wing serrations)



DETAIL VIEW  
VH2, VH4 & VH6 HOLE PLUGS  
(With wing serrations)

## Additional V-Series Ratings

- |           |   |          |  |
|-----------|---|----------|--|
| <b>1</b>  | .4VA @ 28VDC Resistive  | <b>L</b> | 15A 125 VAC, 10A 250VAC, 1/2 HP 125-250 VAC; 6A 125 VAC L  |
| <b>4</b>  | 10A 250VAC 1/2 HP, 15A 125 VAC 1/2 H, No Agency Listings            | <b>M</b> | .4VA/20A 12V (combi-contact)<br>(combination gold/silver contacts for borderline dry circuit applications) |
| <b>5</b>  | 10A 250VAC 1/2 HP, 15A 125 VAC 1/2 HP, UL Recognized, CSA Certified | <b>N</b> | .4VA/15A 24V (combi-contact)<br>(combination gold/silver contacts for borderline dry circuit applications) |
| <b>6*</b> | 15A 125VAC 1/2 HP, 12(2)A 125 VAC $\mu$ T85                         |          |  |
| <b>7*</b> | 15A 125VAC 1/2 HP, 12(6)A 125 VAC T85                               |          |  |
| <b>8*</b> | 10A 250VAC, 15A 125VAC, 1/2 HP 125-250VAC, 12(2)A 250 VAC $\mu$ T85 |          |  |
| <b>9*</b> | 10A 250VAC, 15A 125VAC, 1/2 HP 125-250VAC, 12(6)A 250 VAC T85       |          |  |
| <b>B</b>  | 15A 24V   |          |  |
| <b>C</b>  | 20A 18V   |          |  |
| <b>D</b>  | 20A 12V   |          |  |
| <b>E</b>  | 20A 14V, 10A 14VT (circuits 1, 4, A, & D only)                      |          |  |
| <b>F</b>  | 10A 14V, 6A, 14VT (circuit G only)                                  |          |  |
| <b>G</b>  | 20A 6V  |          |  |
| <b>H</b>  | 20A 3V  |          |  |

**NOTES**

Consult factory to determine availability for individual circuits.  
\* Ratings 6 - 9 are UL, CSA, VDE, DEMKO, SEMKO, NEMKO, FIMKO & BEAB certified, require terminations A or B for double pole circuits, & are not available with illumination circuits 4, 8, D, J, N, & T or with wire lead or solder lug terminations. Circuits 1, 4, A & D are not available with rating 6 & 8. Rating 7 & 9 only available with circuits 1, 4, A & D. Circuits 2, 3, 5, 7, 8, K, L are 1/2 HP 250VAC only with rating 8. Ratings 6 & 7 must specify lamp code 1 (125VAC neon). Ratings 8 & 9 must specify lamp code 2 (250VAC neon). Rating L available with circuits 1, 4, A & D only.