

MC74VHC1G05, MC74VHC1GT05

Single Inverter with Open Drain Output

The MC74VHC1G05 / MC74VHC1GT05 is a single inverter with open drain output in tiny footprint packages.

The input structures provide protection when voltages up to 5.5 V are applied, regardless of the supply voltage. This allows the device to be used to interface 5 V circuits to 3 V circuits. The output structures also provide protection when $V_{CC} = 0$ V and when the output voltage exceeds V_{CC} . These input and output structures help prevent device destruction caused by supply voltage – input/output voltage mismatch, battery backup, hot insertion, etc.

Features

- Designed for 2.0 V to 5.5 V V_{CC} Operation
- 3.5 ns t_{PD} at 5 V (typ)
- Inputs/Outputs Over-Voltage Tolerant up to 5.5 V
- I_{OFF} Supports Partial Power Down Protection
- Source/Sink 8 mA at 3.0 V
- Available in SC-88A, SC-74A, TSOP-5, SOT-553, SOT-953 and UDFN6 Packages
- Chip Complexity < 100 FETs
- NLV Prefix for Automotive and Other Applications Requiring Unique Site and Control Change Requirements; AEC-Q100 Qualified and PPAP Capable
- These Devices are Pb-Free, Halogen Free/BFR Free and are RoHS Compliant

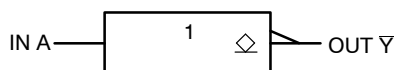

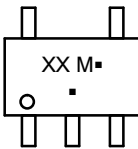

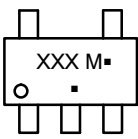

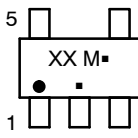



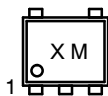





Figure 1. Logic Symbol



ON Semiconductor®

www.onsemi.com

MARKING DIAGRAMS		
	SC-88A DF SUFFIX CASE 419A	
	SC-74A DBV SUFFIX CASE 318BQ	
	TSOP-5 DT SUFFIX CASE 483	
	SOT-553 XV5 SUFFIX CASE 463B	
	SOT-953 P5 SUFFIX CASE 527AE	
	UDFN6 1.45 x 1.0 CASE 517AQ	
	UDFN6 1.0 x 1.0 CASE 517BX	

XX = Specific Device Code
M = Date Code*
▪ = Pb-Free Package

(Note: Microdot may be in either location)

*Date Code orientation and/or position may vary depending upon manufacturing location.

ORDERING INFORMATION

See detailed ordering, marking and shipping information in the package dimensions section on page 7 of this data sheet.

MC74VHC1G05, MC74VHC1GT05

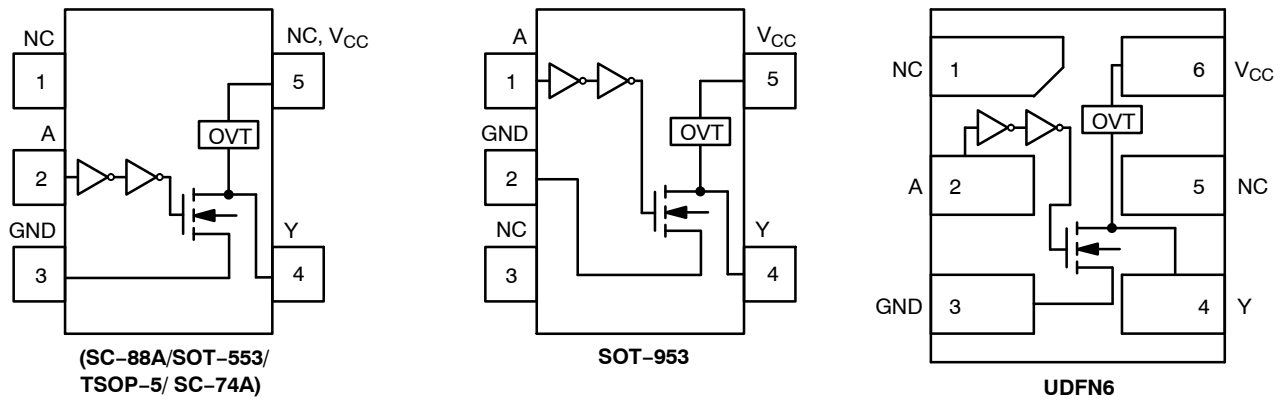

Figure 2. Pinout (Top View)

PIN ASSIGNMENT

(SC-88A/SOT-553/ TSOP-5/ SC-74A)

Pin	Function
1	NC
2	A
3	GND
4	Y
5	V _{CC}

PIN ASSIGNMENT (SOT-953)

Pin	Function
1	A
2	GND
3	NC
4	Y
5	V _{CC}

PIN ASSIGNMENT (UDFN)

Pin	Function
1	NC
2	A
3	GND
4	Y
5	NC
6	V _{CC}

FUNCTION TABLE

A Input	Y Output
L	Z
H	L

MC74VHC1G05, MC74VHC1GT05

MAXIMUM RATINGS

Symbol	Characteristics	Value	Unit
V_{CC}	DC Supply Voltage TSOP-5, SC-88A (NLV) SC-74A, SC-88A, UDFN6, SOT-553, SOT-953	-0.5 to +7.0 -0.5 to +6.5	V
V_{IN}	DC Input Voltage TSOP-5, SC-88A (NLV) SC-74A, SC-88A, UDFN6, SOT-553, SOT-953	-0.5 to +7.0 -0.5 to +6.5	V
V_{OUT}	DC Output Voltage TSOP-5, SC-88A (NLV) Active-Mode (High or Low State) Tri-State Mode (Note 1) Power-Down Mode ($V_{CC} = 0$ V)	-0.5 to $V_{CC} + 0.5$ -0.5 to +7.0 -0.5 to +7.0	V
	DC Output Voltage SC-74A, SC-88A, UDFN6, SOT-553, SOT-953 Active-Mode (High or Low State) Tri-State Mode (Note 1) Power-Down Mode ($V_{CC} = 0$ V)	-0.5 to $V_{CC} + 0.5$ -0.5 to +6.5 -0.5 to +6.5	V
I_{IK}	DC Input Diode Current $V_{IN} < GND$	-20	mA
I_{OK}	DC Output Diode Current $V_{OUT} < GND$	+20	mA
I_{OUT}	DC Output Source/Sink Current	+25	mA
I_{CC} or I_{GND}	DC Supply Current per Supply Pin or Ground Pin	+50	mA
T_{STG}	Storage Temperature Range	-65 to +150	°C
T_L	Lead Temperature, 1 mm from Case for 10 secs	260	°C
T_J	Junction Temperature Under Bias	+150	°C
θ_{JA}	Thermal Resistance (Note 2) SC-88A SC-74A TSOP-5 SOT-553 SOT-953 UDFN6	659 555 555 562 560 382	°C/W
P_D	Power Dissipation in Still Air SC-88A SC-74A TSOP-5 SOT-553 SOT-953 UDFN6	190 225 225 222 223 327	mW
MSL	Moisture Sensitivity	Level 1	-
F_R	Flammability Rating Oxygen Index: 28 to 34	UL 94 V-0 @ 0.125 in	-
V_{ESD}	ESD Withstand Voltage (Note 3) Human Body Model Charged Device Model	2000 1000	V
$I_{Latchup}$	Latchup Performance (Note 4)	± 100	mA

Stresses exceeding those listed in the Maximum Ratings table may damage the device. If any of these limits are exceeded, device functionality should not be assumed, damage may occur and reliability may be affected.

1. Applicable to devices with outputs that may be tri-stated.
2. Measured with minimum pad spacing on an FR4 board, using 10mm-by-1inch, 2 ounce copper trace no air flow.
3. HBM tested to ANSI/ESDA/JEDEC JS-001-2017. CDM tested to EIA/JESD22-C101-F. JEDEC recommends that ESD qualification to EIA/JESD22-A115-A (Machine Model) be discontinued per JEDEC/JEP172A.
4. Tested to EIA/JESD78 Class II.

MC74VHC1G05, MC74VHC1GT05

RECOMMENDED OPERATING CONDITIONS

Symbol	Characteristics	Min	Max	Unit
V _{CC}	Positive DC Supply Voltage	2.0	5.5	V
V _{IN}	DC Input Voltage	0	5.5	V
V _{OUT}	DC Output Voltage TSOP-5, SC-88A (NLV)	0	V _{CC}	V
	DC Output Voltage SC-74A, SC-88A, UDFN6, SOT-553, SOT-953 Active-Mode (High or Low State) Tri-State Mode (Note 1) Power-Down Mode (V _{CC} = 0 V)	0	V _{CC}	
		0	5.5	
T _A	Operating Temperature Range	-55	+125	°C
t _r , t _f	Input Rise and Fall Time TSOP-5, SC-88A (NLV) V _{CC} = 3.0 V to 3.6 V V _{CC} = 4.5 V to 5.5 V	0	100	ns/V
		0	20	
	Input Rise and Fall Time SC-74A, SC-88A, UDFN6, SOT-553, SOT-953 V _{CC} = 1.65 V to 1.95 V V _{CC} = 2.3 V to 2.7 V V _{CC} = 3.0 V to 3.6 V V _{CC} = 4.5 V to 5.5 V	0	20	
		0	20	
		0	10	
		0	5	
		0		

Functional operation above the stresses listed in the Recommended Operating Ranges is not implied. Extended exposure to stresses beyond the Recommended Operating Ranges limits may affect device reliability.

DC ELECTRICAL CHARACTERISTICS (MC74VHC1G05)

Symbol	Parameter	Test Conditions	V _{CC} (V)	T _A = 25°C			-40°C ≤ T _A ≤ 85°C		-55°C ≤ T _A ≤ 125°C		Unit
				Min	Typ	Max	Min	Max	Min	Max	
V _{IH}	High-Level Input Voltage		2.0	1.5	-	-	1.5	-	1.5	-	V
			3.0	2.1	-	-	2.1	-	2.1	-	
			4.5	3.15	-	-	3.15	-	3.15	-	
			5.5	3.85	-	-	3.85	-	3.85	-	
V _{IL}	Low-Level Input Voltage		2.0	-	-	0.5	-	0.5	-	0.5	V
			3.0	-	-	0.9	-	0.9	-	0.9	
			4.5	-	-	1.35	-	1.35	-	1.35	
			5.5	-	-	1.65	-	1.65	-	1.65	
V _{OL}	Low-Level Output Voltage	V _{IN} = V _{IH} or V _{IL} I _{OL} = 50 μA I _{OL} = 50 μA I _{OL} = 50 μA I _{OL} = 4 mA I _{OL} = 8 mA	2.0	-	0.0	0.1	-	0.1	-	0.1	V
			3.0	-	0.0	0.1	-	0.1	-	0.1	
			4.5	-	0.0	0.1	-	0.1	-	0.1	
			3.0	-	-	0.36	-	0.44	-	0.52	
			4.5	-	-	0.36	-	0.44	-	0.52	
I _{IN}	Input Leakage Current	V _{IN} = 5.5 V or GND	1.65 to 5.5	-	-	±0.1*	-	±1.0	-	±1.0	μA
I _{OZ}	3-State Output Leakage Current	V _{OUT} = 0 V to 5.5 V	5.5	-	-	±0.25	-	±2.5	-	±2.5	μA
I _{OFF}	Power Off Leakage Current	V _{IN} = 5.5 V or V _{OUT} = 5.5 V	0	-	-	1.0	-	10	-	10	μA
I _{CC}	Quiescent Supply Current	V _{IN} = V _{CC} or GND	5.5	-	-	1.0	-	20	-	40	μA

*Guaranteed by design.

MC74VHC1G05, MC74VHC1GT05

DC ELECTRICAL CHARACTERISTICS (MC74VHC1GT05)

Symbol	Parameter	Test Conditions	V _{CC} (V)	T _A = 25°C			-40°C ≤ T _A ≤ 85°C		-55°C ≤ T _A ≤ 125°C		Unit
				Min	Typ	Max	Min	Max	Min	Max	
V _{IH}	High-Level Input Voltage		2.0	1.0	-	-	1.0	-	1.0	-	V
			3.0	1.4	-	-	1.4	-	1.4	-	
			4.5	2.0	-	-	2.0	-	2.0	-	
			5.5	2.0	-	-	2.0	-	2.0	-	
V _{IL}	Low-Level Input Voltage		2.0	-	-	0.28	-	0.28	-	0.28	V
			3.0	-	-	0.45	-	0.45	-	0.45	
			4.5	-	-	0.8	-	0.8	-	0.8	
			5.5	-	-	0.8	-	0.8	-	0.8	
V _{OL}	Low-Level Output Voltage	V _{IN} = V _{IH} or V _{IL} I _{OL} = 50 μA I _{OL} = 50 μA I _{OL} = 50 μA I _{OL} = 4 mA I _{OL} = 8 mA	2.0	-	0.0	0.1	-	0.1	-	0.1	V
			3.0	-	0.0	0.1	-	0.1	-	0.1	
			4.5	-	0.0	0.1	-	0.1	-	0.1	
			3.0	-	-	0.36	-	0.44	-	0.52	
			4.5	-	-	0.36	-	0.44	-	0.52	
I _{IN}	Input Leakage Current	V _{IN} = 5.5 V or GND	1.65 to 5.5	-	-	±0.1*	-	±1.0	-	±1.0	μA
I _{OZ}	3-State Output Leakage Current	V _{OUT} = 0 V to 5.5 V	5.5	-	-	±0.25	-	±2.5	-	±2.5	μA
I _{OFF}	Power Off Leakage Current	V _{IN} = 5.5 V or V _{OUT} = 5.5 V	0	-	-	1.0	-	10	-	10	μA
I _{CC}	Quiescent Supply Current	V _{IN} = V _{CC} or GND	5.5	-	-	1.0	-	20	-	40	μA
I _{CCCT}	Increase in Quiescent Supply Current per Input Pin	One Input: V _{IN} = 3.4 V; Other Input at V _{CC} or GND	5.5	-	-	1.35	-	1.5	-	1.65	mA

*Guaranteed by design.

AC ELECTRICAL CHARACTERISTICS (Input t_r = t_f = 3.0 ns)

Symbol	Parameter	Conditions	V _{CC} (V)	T _A = 25°C			-40°C ≤ T _A ≤ 85°C		-55°C ≤ T _A ≤ 125°C		Unit
				Min	Typ	Max	Min	Max	Min	Max	
t _{PZL}	Output Enable Time, OE to Y (Figures 3 and 4)	C _L = 15 pF	3.0 to 3.6	-	5.0	7.1	-	8.5	-	10.0	ns
		C _L = 50 pF		-	7.5	10.6	-	12.0	-	14.5	
		C _L = 15 pF	4.5 to 5.5	-	3.8	5.5	-	6.5	-	8.0	
		C _L = 50 pF		-	5.3	7.5	-	8.5	-	10.0	
t _{PLZ}	Output Disable Time, OE to Y (Figures 3 and 4)	C _L = 15 pF	3.0 to 3.6	-	6.5	9.7	-	11.5	-	12.55	ns
		C _L = 50 pF		-	7.5	10.6	-	12.0	-	14.5	
		C _L = 15 pF	4.5 to 5.5	-	4.8	6.8	-	8.0	-	9.0	
		C _L = 50 pF		-	5.3	7.5	-	8.5	-	10.0	
C _{IN}	Input Capacitance			-	4.0	10	-	10	-	10	pF
C _{OUT}	Output Capacitance	Output in High Impedance State		-	6.0	-	-	-	-	-	pF

C _{PD}	Power Dissipation Capacitance (Note 5)	Typical @ 25°C, V _{CC} = 5.0 V	
		Value	Unit
		8.0	pF

5. C_{PD} is defined as the value of the internal equivalent capacitance which is calculated from the operating current consumption without load. Average operating current can be obtained by the equation: I_{CC(OPR)} = C_{PD} • V_{CC} • f_{in} + I_{CC}. C_{PD} is used to determine the no-load dynamic power consumption; P_D = C_{PD} • V_{CC}² • f_{in} + I_{CC} • V_{CC}.

MC74VHC1G05, MC74VHC1GT05

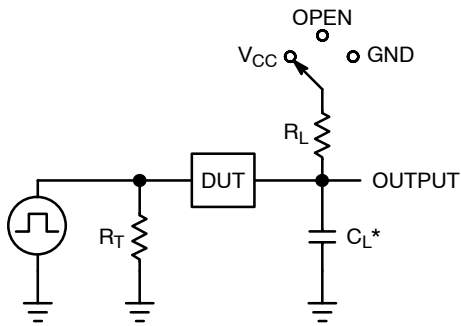

C_L includes probe and jig capacitance
 R_T is Z_{OUT} of pulse generator (typically 50 Ω)
 $f = 1$ MHz

Figure 3. Test Circuit

Test	Switch Position	C_L , pF	R_L , Ω
t_{PLH} / t_{PHL}	Open	See AC Characteristics Table	X
t_{PLZ} / t_{PZL}	V_{CC}		1 k
t_{PHZ} / t_{PZH}	GND		1 k

X = Don't Care



Figure 4. Switching Waveforms

V_{CC} , V	V_{mi} , V	V_{mo} , V		V_Y , V
		t_{PLH} , t_{PHL}	t_{PZL} , t_{PLZ} , t_{PZH} , t_{PHZ}	
3.0 to 3.6	$V_{CC}/2$	$(V_{OH} - V_{OL})/2$	$V_{CC}/2$	0.3
4.5 to 5.5	$V_{CC}/2$	$(V_{OH} - V_{OL})/2$	$V_{CC}/2$	0.3

MC74VHC1G05, MC74VHC1GT05

ORDERING INFORMATION

Device	Packages	Specific Device Code	Pin 1 Orientation (See below)	Shipping [†]
MC74VHC1G05DFT1G	SC-88A	VF	Q2	3000 / Tape & Reel
MC74VHC1G05DFT2G	SC-88A	VF	Q4	3000 / Tape & Reel
NLVVHC1G05DFT1G*	SC-88A	VF	Q2	3000 / Tape & Reel
NLVVHC1G05DFT2G*	SC-88A	VF	Q4	3000 / Tape & Reel
MC74VHC1GT05DFT1G (In Development)	SC-88A	TBD	Q4	3000 / Tape & Reel
MC74VHC1GT05DFT2G	SC-88A	TBD	Q2	3000 / Tape & Reel
MC74VHC1G05DBVT1G (In Development)	SC-74A	TBD	Q4	3000 / Tape & Reel
MC74VHC1GT05DBVT1G (In Development)	SC-74A	TBD	Q4	3000 / Tape & Reel
MC74VHC1G05DTT1G	TSOP-5	VF	Q4	3000 / Tape & Reel
MC74VHC1GT05DTT1G (In Development)	TSOP-5	TBD	Q4	3000 / Tape & Reel
MC74VHC1G05XV5T2G (In Development)	SOT-553	TBD	Q4	3000 / Tape & Reel
MC74VHC1GT05XV5T2G (In Development)	SOT-553	TBD	Q4	3000 / Tape & Reel
MC74VHC1G05P5T5G (In Development)	SOT-953	TBD	Q2	4000 / Tape & Reel
MC74VHC1GT05P5T5G (In Development)	SOT-953	TBD	Q2	4000 / Tape & Reel
MC74VHC1G05MU1TCG (In Development)	UDFN6, 1.45 x 1.0, 0.5P	TBD	Q4	3000 / Tape & Reel
MC74VHC1GT05MU1TCG (In Development)	UDFN6, 1.45 x 1.0, 0.5P	TBD	Q4	3000 / Tape & Reel
MC74VHC1G05MU3TCG (In Development)	UDFN6, 1.0 x 1.0, 0.35	TBD	Q4	3000 / Tape & Reel
MC74VHC1GT05MU3TCG (In Development)	UDFN6, 1.0 x 1.0, 0.35	TBD	Q4	3000 / Tape & Reel

[†]For information on tape and reel specifications, including part orientation and tape sizes, please refer to our Tape and Reel Packaging Specifications Brochure, BRD8011/D.

*NLV Prefix for Automotive and Other Applications Requiring Unique Site and Control Change Requirements; AEC-Q100 Qualified and PPAP Capable.

Pin 1 Orientation in Tape and Reel

Direction of Feed

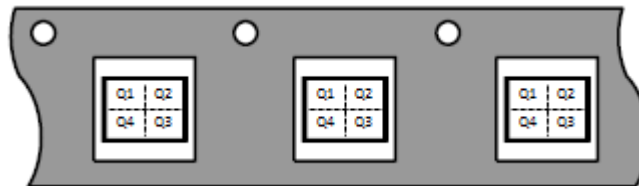

MC74VHC1G05, MC74VHC1GT05

PACKAGE DIMENSIONS

SC-88A (SC-70-5/SOT-353)
CASE 419A-02
ISSUE L



NOTES:

1. DIMENSIONING AND TOLERANCING PER ANSI Y14.5M, 1982.
2. CONTROLLING DIMENSION: INCH.
3. 419A-01 OBSOLETE. NEW STANDARD 419A-02.
4. DIMENSIONS A AND B DO NOT INCLUDE MOLD FLASH, PROTRUSIONS, OR GATE BURRS.

DIM	INCHES		MILLIMETERS	
	MIN	MAX	MIN	MAX
A	0.071	0.087	1.80	2.20
B	0.045	0.053	1.15	1.35
C	0.031	0.043	0.80	1.10
D	0.004	0.012	0.10	0.30
G	0.026 BSC		0.65 BSC	
H	---	0.004	---	0.10
J	0.004	0.010	0.10	0.25
K	0.004	0.012	0.10	0.30
N	0.008 REF		0.20 REF	
S	0.079	0.087	2.00	2.20



SOLDER FOOTPRINT*



*For additional information on our Pb-Free strategy and soldering details, please download the ON Semiconductor Soldering and Mounting Techniques Reference Manual, SOLDERRM/D.

MC74VHC1G05, MC74VHC1GT05

PACKAGE DIMENSIONS

SC-74A
CASE 318BQ
ISSUE B



NOTES:

1. DIMENSIONING AND TOLERANCING PER ASME Y14.5M, 1994.
2. CONTROLLING DIMENSION: MILLIMETERS.
3. MAXIMUM LEAD THICKNESS INCLUDES LEAD FINISH THICKNESS. MINIMUM LEAD THICKNESS IS THE MINIMUM THICKNESS OF BASE MATERIAL.
4. DIMENSIONS A AND B DO NOT INCLUDE MOLD FLASH, PROTRUSIONS, OR GATE BURRS. MOLD FLASH, PROTRUSIONS, OR GATE BURRS SHALL NOT EXCEED 0.15 PER SIDE.

DIM	MILLIMETERS	
	MIN	MAX
A	0.90	1.10
A1	0.01	0.10
b	0.25	0.50
c	0.10	0.26
D	2.85	3.15
E	2.50	3.00
E1	1.35	1.65
e	0.95 BSC	
L	0.20	0.60
M	0° 10°	

RECOMMENDED SOLDERING FOOTPRINT*

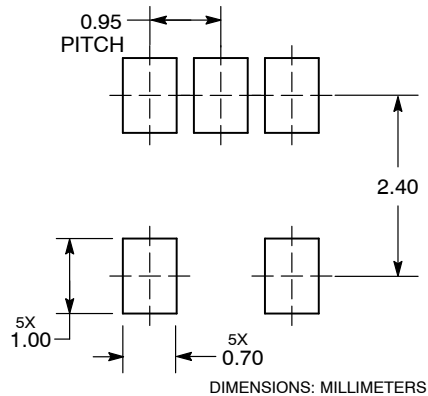

DIMENSIONS: MILLIMETERS

*For additional information on our Pb-Free strategy and soldering details, please download the ON Semiconductor Soldering and Mounting Techniques Reference Manual, SOLDERRM/D.

MC74VHC1G05, MC74VHC1GT05

PACKAGE DIMENSIONS

TSOP-5
CASE 483-02
ISSUE M

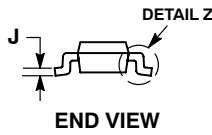
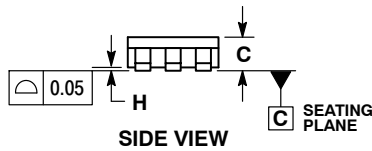
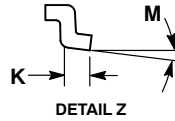
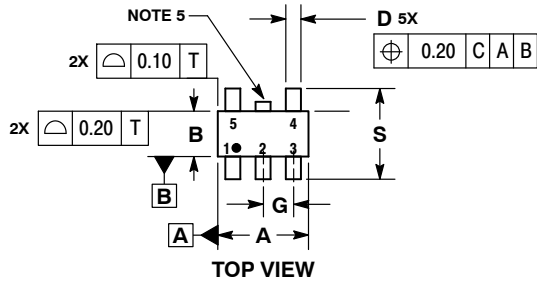

NOTES:

1. DIMENSIONING AND TOLERANCING PER ASME Y14.5M, 1994.
2. CONTROLLING DIMENSION: MILLIMETERS.
3. MAXIMUM LEAD THICKNESS INCLUDES LEAD FINISH THICKNESS. MINIMUM LEAD THICKNESS IS THE MINIMUM THICKNESS OF BASE MATERIAL.
4. DIMENSIONS A AND B DO NOT INCLUDE MOLD FLASH, PROTRUSIONS, OR GATE BURRS. MOLD FLASH, PROTRUSIONS, OR GATE BURRS SHALL NOT EXCEED 0.15 PER SIDE. DIMENSION A.
5. OPTIONAL CONSTRUCTION: AN ADDITIONAL TRIMMED LEAD IS ALLOWED IN THIS LOCATION. TRIMMED LEAD NOT TO EXTEND MORE THAN 0.2 FROM BODY.

MILLIMETERS		
DIM	MIN	MAX
A	2.85	3.15
B	1.35	1.65
C	0.90	1.10
D	0.25	0.50
G	0.95 BSC	
H	0.01	0.10
J	0.10	0.26
K	0.20	0.60
M	0° 10°	
S	2.50	3.00

SOLDERING FOOTPRINT*



*For additional information on our Pb-Free strategy and soldering details, please download the ON Semiconductor Soldering and Mounting Techniques Reference Manual, SOLDERRM/D.

MC74VHC1G05, MC74VHC1GT05

PACKAGE DIMENSIONS

SOT-553, 5 LEAD CASE 463B ISSUE C



NOTES:

1. DIMENSIONING AND TOLERANCING PER ANSI Y14.5M, 1982.
2. CONTROLLING DIMENSION: MILLIMETERS
3. MAXIMUM LEAD THICKNESS INCLUDES LEAD FINISH THICKNESS. MINIMUM LEAD THICKNESS IS THE MINIMUM THICKNESS OF BASE MATERIAL.

DIM	MILLIMETERS			INCHES		
	MIN	NOM	MAX	MIN	NOM	MAX
A	0.50	0.55	0.60	0.020	0.022	0.024
b	0.17	0.22	0.27	0.007	0.009	0.011
c	0.08	0.13	0.18	0.003	0.005	0.007
D	1.55	1.60	1.65	0.061	0.063	0.065
E	1.15	1.20	1.25	0.045	0.047	0.049
e	0.50 BSC			0.020 BSC		
L	0.10	0.20	0.30	0.004	0.008	0.012
H _E	1.55	1.60	1.65	0.061	0.063	0.065

SOLDERING FOOTPRINT*



*For additional information on our Pb-Free strategy and soldering details, please download the ON Semiconductor Soldering and Mounting Techniques Reference Manual, SOLDERRM/D.

MC74VHC1G05, MC74VHC1GT05

PACKAGE DIMENSIONS

SOT-953
CASE 527AE
ISSUE E



NOTES:

1. DIMENSIONING AND TOLERANCING PER ASME Y14.5M, 1994.
2. CONTROLLING DIMENSION: MILLIMETERS
3. MAXIMUM LEAD THICKNESS INCLUDES LEAD FINISH. MINIMUM LEAD THICKNESS IS THE MINIMUM THICKNESS OF THE BASE MATERIAL.
4. DIMENSIONS D AND E DO NOT INCLUDE MOLD FLASH, PROTRUSIONS, OR GATE BURRS.

MILLIMETERS			
DIM	MIN	NOM	MAX
A	0.34	0.37	0.40
b	0.10	0.15	0.20
C	0.07	0.12	0.17
D	0.95	1.00	1.05
E	0.75	0.80	0.85
e	0.35 BSC		
H _E	0.95	1.00	1.05
L	0.175 REF		
L2	0.05	0.10	0.15
L3	---	---	0.15

SOLDERING FOOTPRINT*



DIMENSIONS: MILLIMETERS

*For additional information on our Pb-Free strategy and soldering details, please download the ON Semiconductor Soldering and Mounting Techniques Reference Manual, SOLDERM/D.

MC74VHC1G05, MC74VHC1GT05

PACKAGE DIMENSIONS

UDFN6, 1.45x1.0, 0.5P
CASE 517AQ
ISSUE O

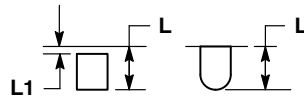

DETAIL A
OPTIONAL
CONSTRUCTIONS



DETAIL B
OPTIONAL
CONSTRUCTIONS

NOTES:

1. DIMENSIONING AND TOLERANCING PER ASME Y14.5M, 1994.
2. CONTROLLING DIMENSION: MILLIMETERS.
3. DIMENSION b APPLIES TO PLATED TERMINAL AND IS MEASURED BETWEEN 0.15 AND 0.30 mm FROM THE TERMINAL TIP.

MILLIMETERS		
DIM	MIN	MAX
A	0.45	0.55
A1	0.00	0.05
A2	0.07	REF
b	0.20	0.30
D	1.45	BSC
E	1.00	BSC
e	0.50	BSC
L	0.30	0.40
L1	---	0.15

MOUNTING FOOTPRINT



DIMENSIONS: MILLIMETERS

*For additional information on our Pb-Free strategy and soldering details, please download the ON Semiconductor Soldering and Mounting Techniques Reference Manual, SOLDERRM/D.

MC74VHC1G05, MC74VHC1GT05

PACKAGE DIMENSIONS

UDFN6, 1x1, 0.35P
CASE 517BX
ISSUE O

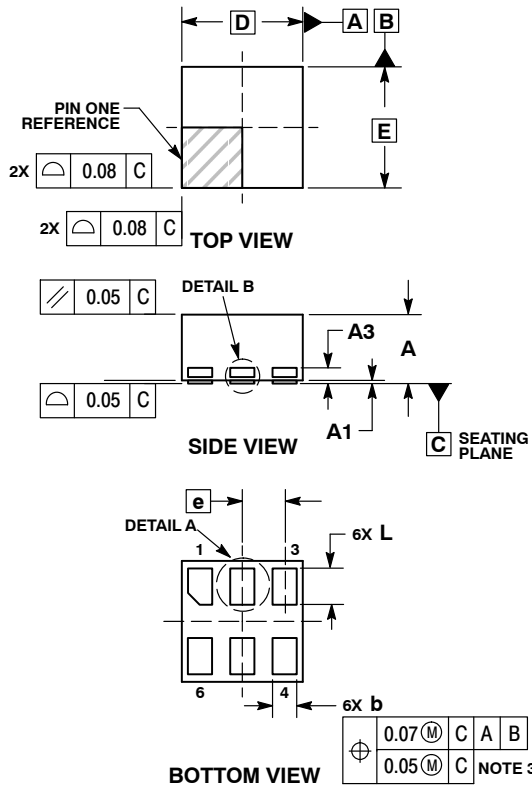

NOTES:

1. DIMENSIONING AND TOLERANCING PER ASME Y14.5M, 1994.
2. CONTROLLING DIMENSION: MILLIMETERS.
3. DIMENSION b APPLIES TO PLATED TERMINAL AND IS MEASURED BETWEEN 0.15 AND 0.20 MM FROM TERMINAL TIP.
4. PACKAGE DIMENSIONS EXCLUSIVE OF BURRS AND MOLD FLASH.

DIM	MILLIMETERS	
	MIN	MAX
A	0.50	0.65
A1	0.00	0.05
A3	0.13	REF
b	0.17	0.23
D	1.00	BSC
E	1.00	BSC
e	0.35	
L	0.20	0.40
L1	---	0.15
L3	0.26	0.33

RECOMMENDED SOLDERING FOOTPRINT*



DIMENSION: MILLIMETERS

*For additional information on our Pb-Free strategy and soldering details, please download the ON Semiconductor Soldering and Mounting Techniques Reference Manual, SOLDERRM/D.

ON Semiconductor and are trademarks of Semiconductor Components Industries, LLC dba ON Semiconductor or its subsidiaries in the United States and/or other countries. ON Semiconductor owns the rights to a number of patents, trademarks, copyrights, trade secrets, and other intellectual property. A listing of ON Semiconductor's product/patent coverage may be accessed at www.onsemi.com/site/pdf/Patent-Marking.pdf. ON Semiconductor reserves the right to make changes without further notice to any products herein. ON Semiconductor makes no warranty, representation or guarantee regarding the suitability of its products for any particular purpose, nor does ON Semiconductor assume any liability arising out of the application or use of any product or circuit, and specifically disclaims any and all liability, including without limitation special, consequential or incidental damages. Buyer is responsible for its products and applications using ON Semiconductor products, including compliance with all laws, regulations and safety requirements or standards, regardless of any support or applications information provided by ON Semiconductor. "Typical" parameters which may be provided in ON Semiconductor data sheets and/or specifications can and do vary in different applications and actual performance may vary over time. All operating parameters, including "Typicals" must be validated for each customer application by customer's technical experts. ON Semiconductor does not convey any license under its patent rights nor the rights of others. ON Semiconductor products are not designed, intended, or authorized for use as a critical component in life support systems or any FDA Class 3 medical devices or medical devices with a same or similar classification in a foreign jurisdiction or any devices intended for implantation in the human body. Should Buyer purchase or use ON Semiconductor products for any such unintended or unauthorized application, Buyer shall indemnify and hold ON Semiconductor and its officers, employees, subsidiaries, affiliates, and distributors harmless against all claims, costs, damages, and expenses, and reasonable attorney fees arising out of, directly or indirectly, any claim of personal injury or death associated with such unintended or unauthorized use, even if such claim alleges that ON Semiconductor was negligent regarding the design or manufacture of the part. ON Semiconductor is an Equal Opportunity/Affirmative Action Employer. This literature is subject to all applicable copyright laws and is not for resale in any manner.

PUBLICATION ORDERING INFORMATION

LITERATURE FULFILLMENT:

Literature Distribution Center for ON Semiconductor
19521 E. 32nd Pkwy, Aurora, Colorado 80011 USA
Phone: 303-675-2175 or 800-344-3860 Toll Free USA/Canada
Fax: 303-675-2176 or 800-344-3867 Toll Free USA/Canada
Email: orderlit@onsemi.com

N. American Technical Support: 800-282-9855 Toll Free
USA/Canada
Europe, Middle East and Africa Technical Support:
Phone: 421 33 790 2910

ON Semiconductor Website: www.onsemi.com

Order Literature: <http://www.onsemi.com/orderlit>

For additional information, please contact your local Sales Representative