

Features:

- 3G/4G LTE antenna
- Fully SMT compatible
- RoHS compliant
- 40 x 7 x 3 mm
- Tape & Reel packing
- MSL-3
- Part numbers:
 - W3796
 - W3796NL
(for no Pulse Logo Version)

Applications:

- Devices requiring high performance compact internal 3G/4G antenna
- Suitable for 2xMiMo use when mounting two pcs W3796 onto radio board

Issue: 1903

In the effort to improve our products, we reserve the right to make changes judged to be necessary.

CONFIDENTIAL AND PROPRIETARY INFORMATION

This document contains confidential and proprietary information of Pulse Electronics, Inc. (Pulse) and is protected by copyright, trade secret and other state and federal laws. Its receipt or possession does not convey any rights to reproduce, disclose its contents, or to manufacture, use or sell anything it may describe. Reproduction, disclosure or use without specific written authorization of Pulse is strictly forbidden.

For more information:

Pulse Worldwide Headquarters
15255 Innovation Drive #100
San Diego, CA 92128
USA
Tel: 1-858-674-8100

Pulse/Larsen Antennas
18110 SE 34th St Bldg 2 Suite 250
Vancouver, WA 98683
USA
Tel: 1-360-944-7551

Europe Headquarters
Pulse GmbH & Do, KG
Zeppelinstrasse 15
Herrenberg, Germany
Tel: 49 7032 7806 0

Pulse (Suzhou) Wireless Products Co, Inc.
99 Huo Ju Road(#29 Bldg,4th Phase
Suzhou New District
Jiangsu Province, Suzhou 215009 PR China
Tel: 86 512 6807 9998



Description: 698-960MHz, 1427.9-1660.5MHz,
1695-2200MHz, 2300-2700MHz

Series: DOMINO

PART NUMBER: W3796

ELECTRICAL SPECIFICATIONS

Antenna Type	PCB, SMD
Frequency	698-960 / 1427.9-1660.5/ 1695-2200 / 2300-2700MHz
Nominal Impedance	50 Ω
VSWR	3 : 1
Return loss	6dB
Total Efficiency (698-960MHz)	65%
Total Efficiency (1427.9-1660.5MHz)	55%
Total Efficiency (1695-2200MHz)	75%
Total Efficiency (2300-2700MHz)	70%
Average Peak Gain (698-960MHz)	1.5dBi
Average Peak Gain (1427.9-1660.5MHz)	2dBi
Average Peak Gain (1695-2200MHz)	5.5dBi
Average Peak Gain (2300-2700MHz)	5dBi
Average Gain (698-960MHz)	-2.5dBi
Average Gain (1427.9-1660.5MHz)	-3dBi
Average Gain (1695-2200MHz)	-2dBi
Average Gain (2300-2700MHz)	-1.5dBi
Maximum power input	5W

(*) All RF parameters measured on Pulse reference test PCB

MECHANICAL SPECIFICATIONS



Color	Black
Size	40mm(L) * 7mm(W) * 3mm(T)
Weight	1.65 g
Fixing system	SMT
MSL (MOISTURE SENSITIVITY LEVEL)	3

ENVIRONMENTAL SPECIFICATIONS

Operating Temperature	-40 ~ +85° C
Storage Temperature	24 hrs at 85 ° C and 24 hrs at -40 ° C per MIL STD 801G Method 501.5 (high) Method 502.5 (low)
Humidity	24hrs at 30 ° C and 93%RH per MIL STD 810G Method 507.5
RoHS Compliant	Yes

OTHER SPECIFICATIONS

1. W3796 Push Force Test

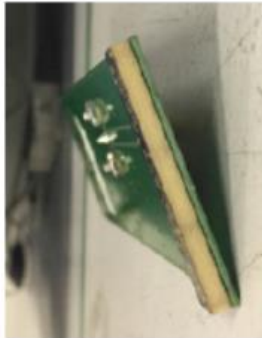
Project Name:		W3796-K			
Test Item:		Push Force > 10N			
Sample #	Picture_Test Before	Test Setup	Picture_Test After	Test Value Antenna	Conclusion
1				86.16	Pass
2				64	Pass
3				65.00	Pass
4				75	Pass
5				80.00	Pass
Conclusion:	Antenna Push test passed.				

OTHER SPECIFICATIONS

2.. W3796 Drop Test

The following sample/application is just for reference to show how to conduct the drop test when the PCB antennas W3796 is SMT on a PCB of a device.

Fig.1: Appearance photos of the samples before test.



Test Method: The whole assembly at 1 meter drop. A minimum of one drop per orientation - flat top, bottom, side and corner (a total of 4 drops). It's recommended to get one drop on flat top, bottom, all four flat sides and four top corners, a total of 10 drops. (Note: MIL STD and JASO D001-1994 cites to drop products on a 2 inch plywood backed by concrete floor)

P.S.:

When doing the structure design, please keep enough safe space between the W3796 and the housing, and also fix the PCB firmly in the housing to avoid any impact during the drop test.

MECHANICAL DRAWING

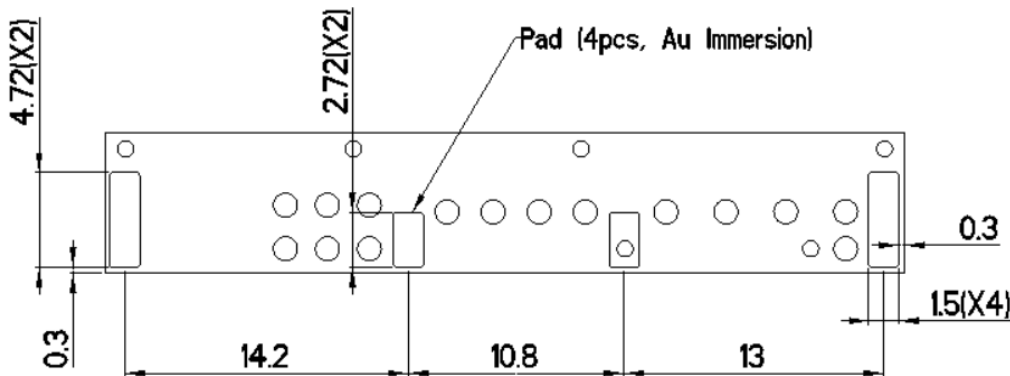
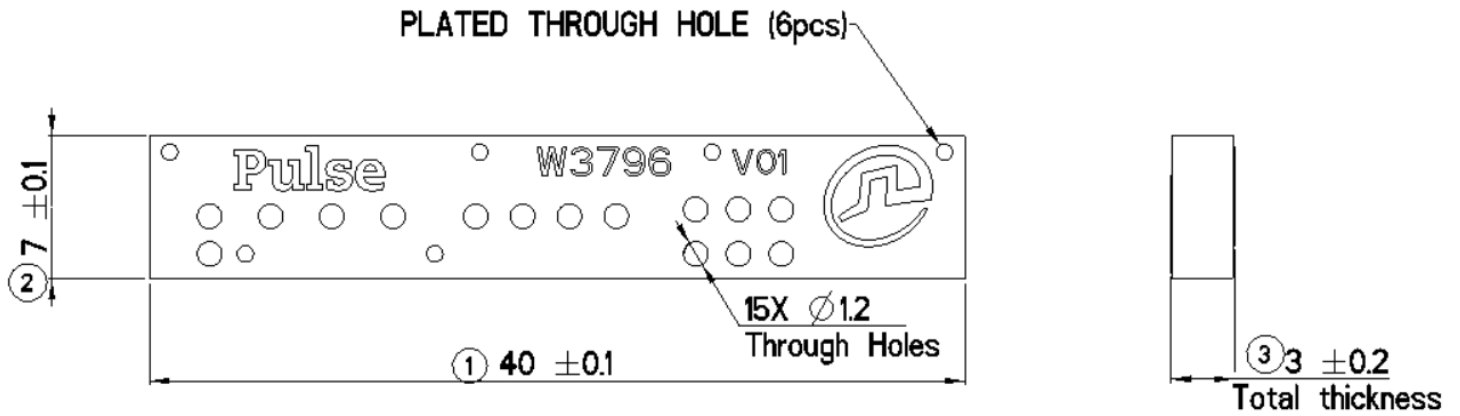

All dimensions are measured in mm.

TEST SETUP

Pulse reference test PCB for W3796 antenna

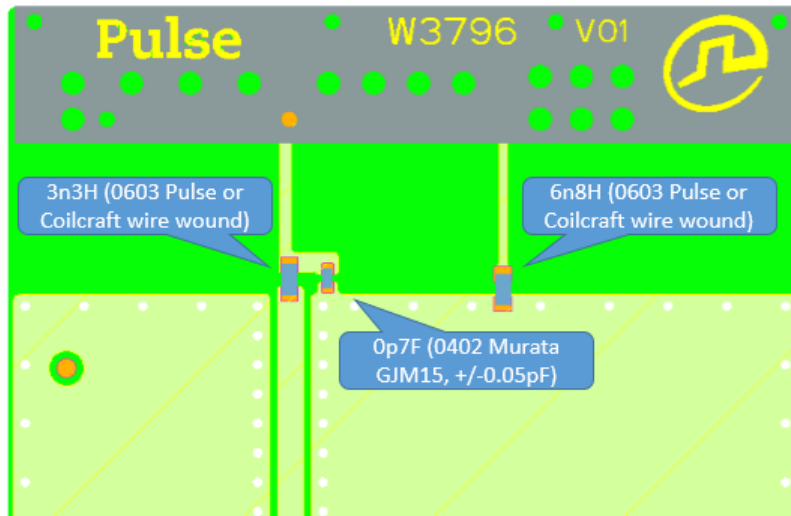
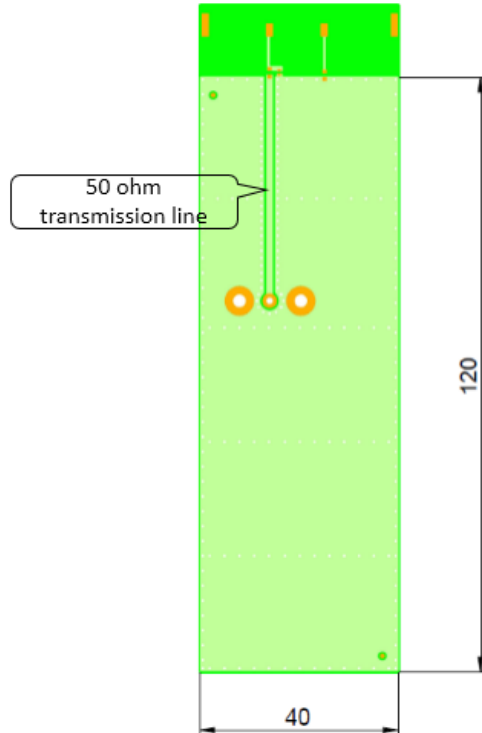

Ground clearance dimensions (mm) and matching component values

Issue: 1903

In the effort to improve our products, we reserve the right to make changes judged to be necessary.

CONFIDENTIAL AND PROPRIETARY INFORMATION

This document contains confidential and proprietary information of Pulse Electronics, Inc. (Pulse) and is protected by copyright, trade secret and other state and federal laws. Its receipt or possession does not convey any rights to reproduce, disclose its contents, or to manufacture, use or sell anything it may describe. Reproduction, disclosure or use without specific written authorization of Pulse is strictly forbidden.

CHARTS

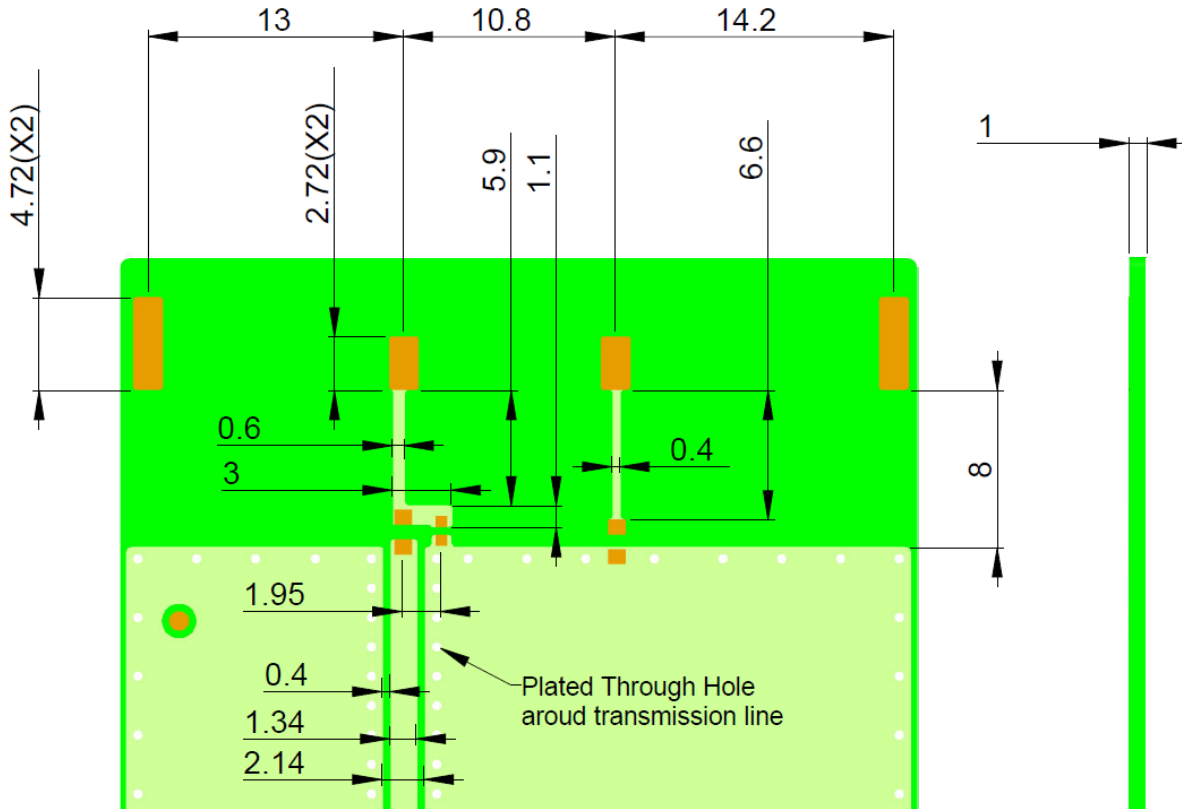

Recommended test board PCB layout for electrical characteristic measurement. Substrate material FR4.

All dimensions are in mm

CHARTS

Charts (free space measurements on Pulse reference test PCB)

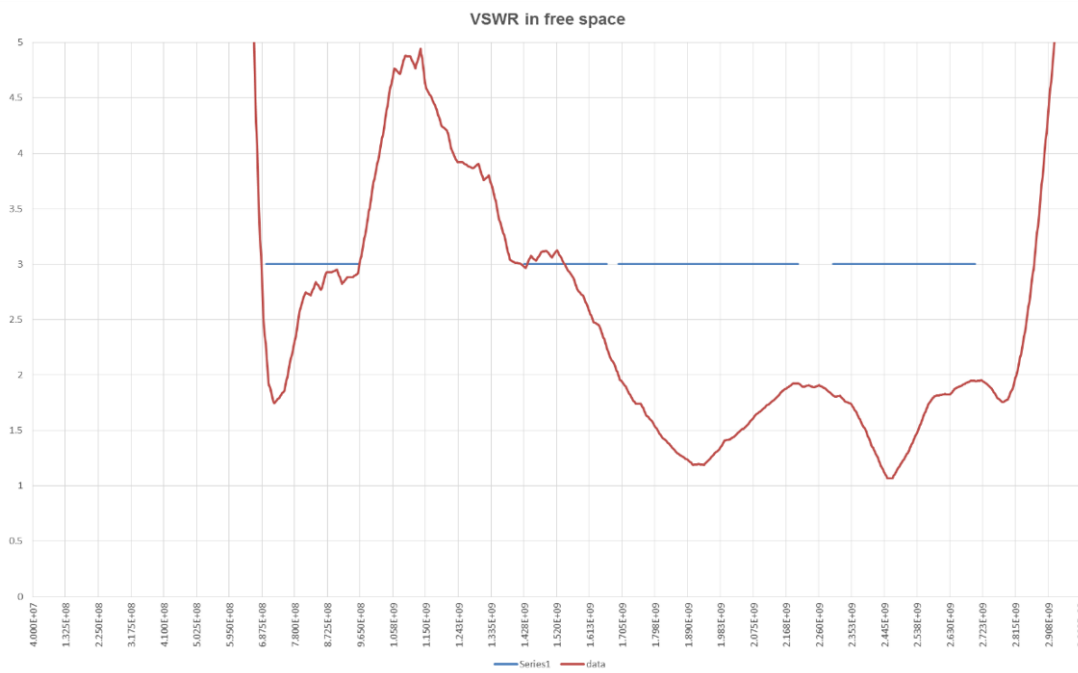
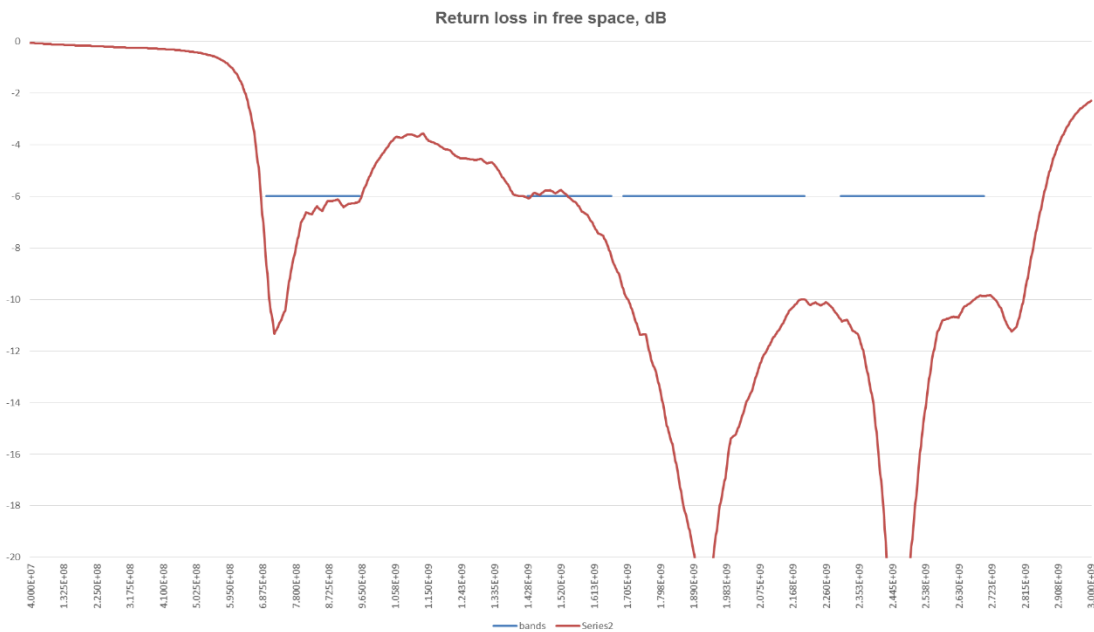

Issue: 1903

In the effort to improve our products, we reserve the right to make changes judged to be necessary.

CONFIDENTIAL AND PROPRIETARY INFORMATION

This document contains confidential and proprietary information of Pulse Electronics, Inc. (Pulse) and is protected by copyright, trade secret and other state and federal laws. Its receipt or possession does not convey any rights to reproduce, disclose its contents, or to manufacture, use or sell anything it may describe. Reproduction, disclosure or use without specific written authorization of Pulse is strictly forbidden.

CHARTS

Efficiency in free space, %

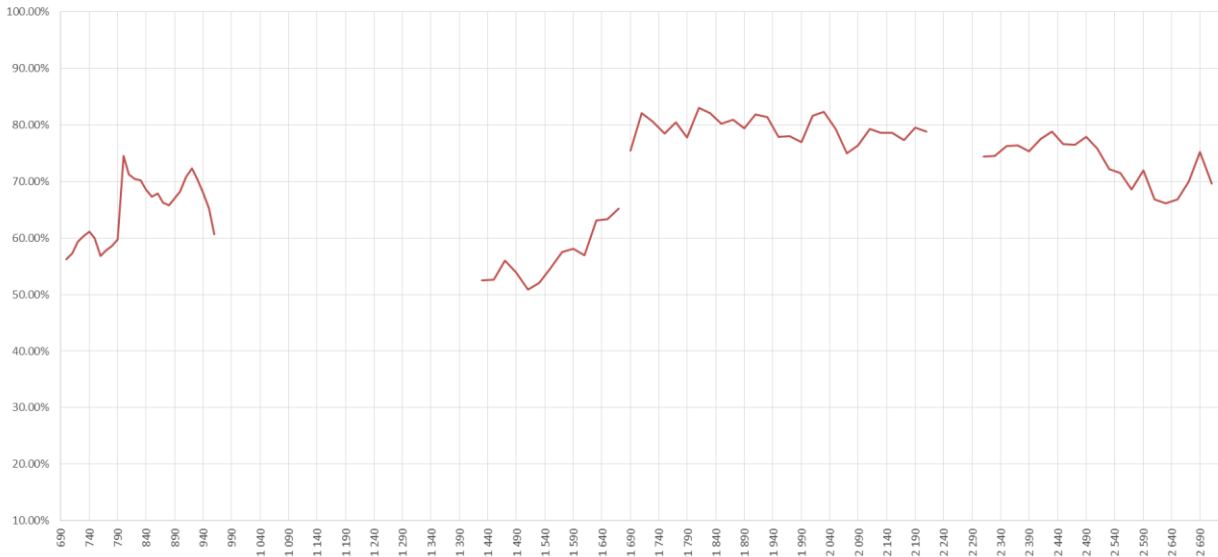

Peak gain, dBi

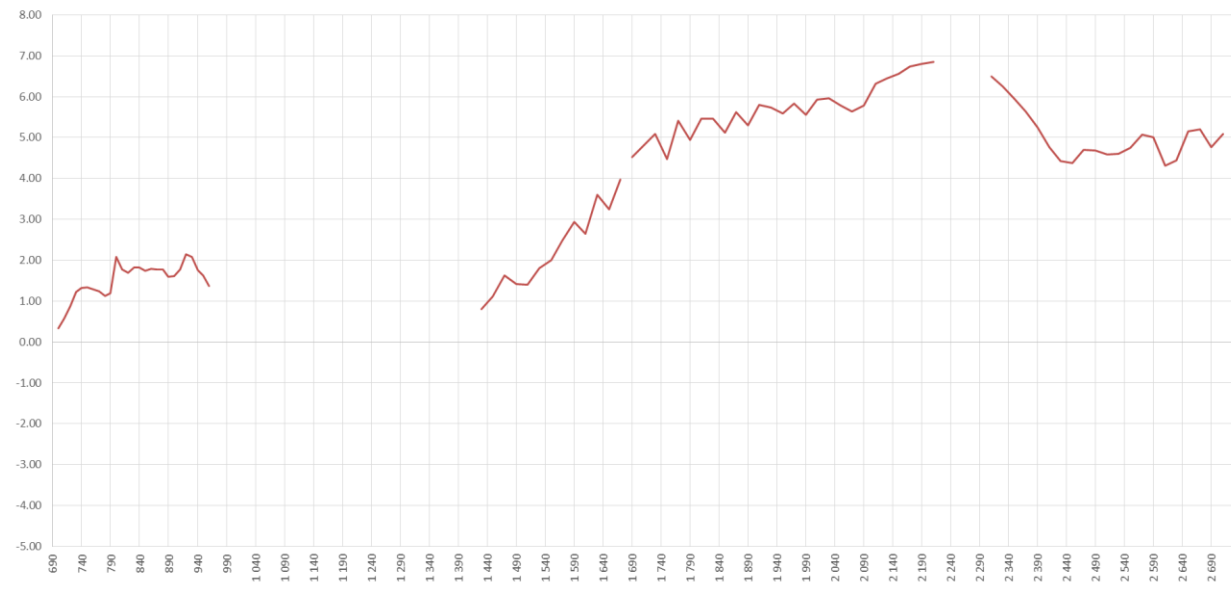

Issue: 1903

In the effort to improve our products, we reserve the right to make changes judged to be necessary.

CONFIDENTIAL AND PROPRIETARY INFORMATION

This document contains confidential and proprietary information of Pulse Electronics, Inc. (Pulse) and is protected by copyright, trade secret and other state and federal laws. Its receipt or possession does not convey any rights to reproduce, disclose its contents, or to manufacture, use or sell anything it may describe. Reproduction, disclosure or use without specific written authorization of Pulse is strictly forbidden.

CHARTS

Average gain, dBi

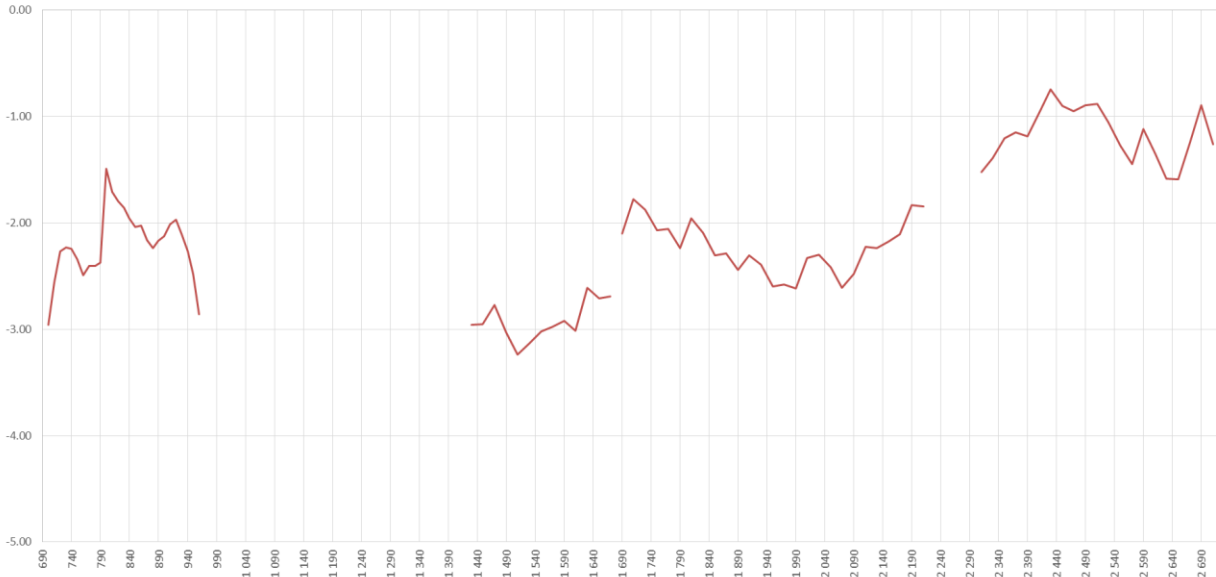

CHARTS

698-960MHz

Vertical plot, front view

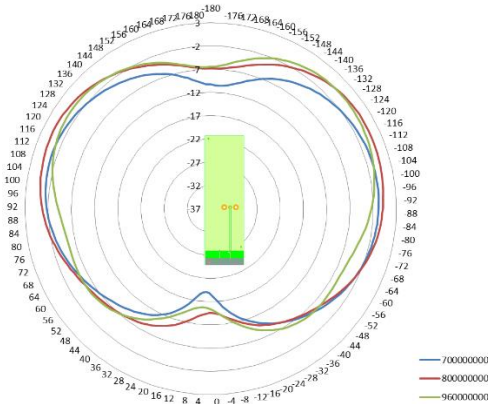

Vertical plot, side view

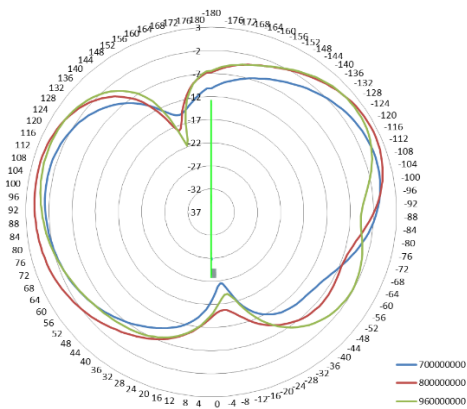

Horizontal plot

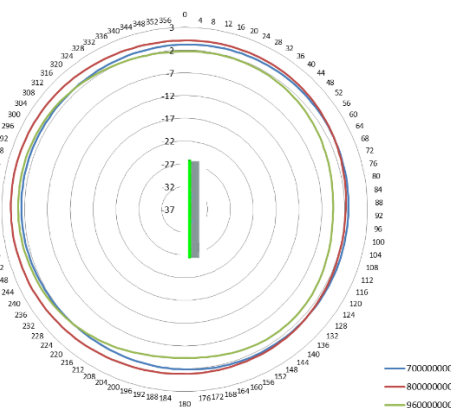

Issue: 1903

In the effort to improve our products, we reserve the right to make changes judged to be necessary.

CONFIDENTIAL AND PROPRIETARY INFORMATION

This document contains confidential and proprietary information of Pulse Electronics, Inc. (Pulse) and is protected by copyright, trade secret and other state and federal laws. Its receipt or possession does not convey any rights to reproduce, disclose its contents, or to manufacture, use or sell anything it may describe. Reproduction, disclosure or use without specific written authorization of Pulse is strictly forbidden.

CHARTS

1427.9-1660.5MHz

Vertical plot, front view

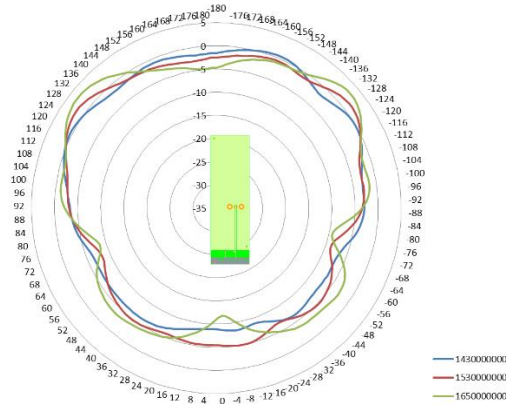

Vertical plot, side view

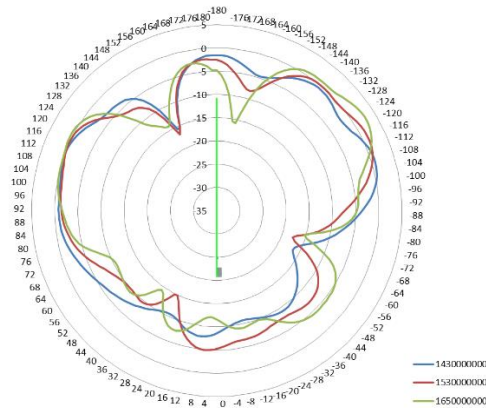

Horizontal plot

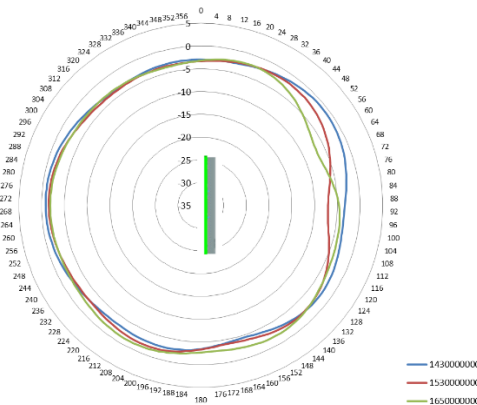

Issue: 1903

In the effort to improve our products, we reserve the right to change specifications without notice. This document contains confidential and proprietary information of Pulse Electronics, Inc. (Pulse) and is protected by copyright, trade secret and other state and federal laws. Its receipt or possession does not convey any rights to reproduce, disclose its contents, or to manufacture, use or sell anything it may describe. Reproduction, disclosure or use without specific written authorization of Pulse is strictly forbidden.

This document contains confidential and proprietary information of Pulse Electronics, Inc. (Pulse) and is protected by copyright, trade secret and other state and federal laws. Its receipt or possession does not convey any rights to reproduce, disclose its contents, or to manufacture, use or sell anything it may describe. Reproduction, disclosure or use without specific written authorization of Pulse is strictly forbidden.

CHARTS

1695-2200MHz

Vertical plot, front view

Vertical plot, side view

Horizontal plot

Issue: 1903

In the effort to improve our products, we reserve the right to make changes judged to be necessary.

CONFIDENTIAL AND PROPRIETARY INFORMATION

This document contains confidential and proprietary information of Pulse Electronics, Inc. (Pulse) and is protected by copyright, trade secret and other state and federal laws. Its receipt or possession does not convey any rights to reproduce, disclose its contents, or to manufacture, use or sell anything it may describe. Reproduction, disclosure or use without specific written authorization of Pulse is strictly forbidden.

RoHS
COMPLIANT

14

CHARTS

2300-2700MHz:

Vertical plot, front view

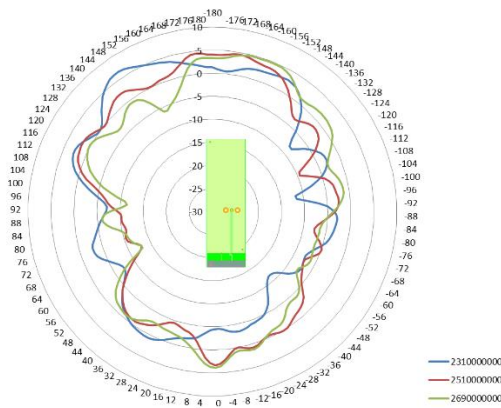

Vertical plot, side view

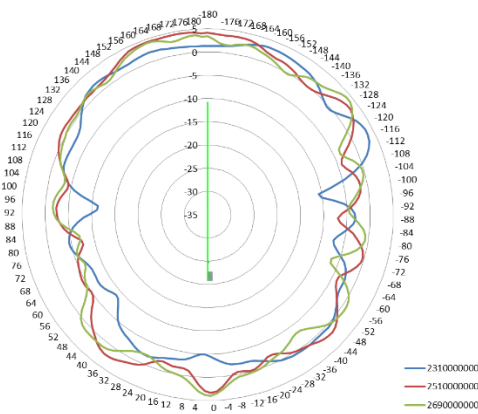

Horizontal plot

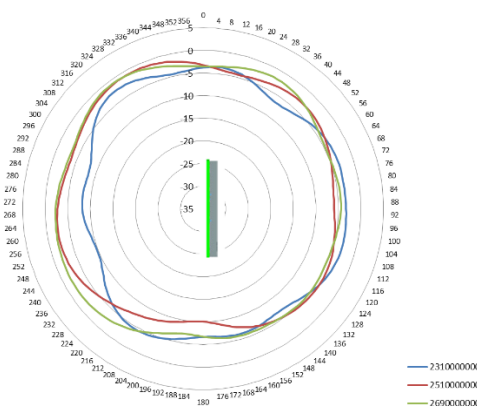

Issue: 1903

In the effort to improve our products, we reserve the right to make changes judged to be necessary.

CONFIDENTIAL AND PROPRIETARY INFORMATION

This document contains confidential and proprietary information of Pulse Electronics, Inc. (Pulse) and is protected by copyright, trade secret and other state and federal laws. Its receipt or possession does not convey any rights to reproduce, disclose its contents, or to manufacture, use or sell anything it may describe. Reproduction, disclosure or use without specific written authorization of Pulse is strictly forbidden.

Recommendation for reflow soldering process

Printing stencil thickness 0,15 - 0,25 mm is recommended for the solder paste. The maximum soldering temperature should not exceed 260°C. The temperature profile recommendations for reflow soldering process is presented in the Figures 1 and 2. The reflow profile

presented in figure 1 describes minimum reflow temperatures. The reflow profile presented in figure 2 describes maximum reflow temperatures. located at the center of the coverage area.

	Method of heat transfer	Controlled hot air convection
1	Average temperature gradient in preheating	2.5 °C/s
2	Soak time	2-3 minutes
3	Max temperature gradient in reflow	3 °C/s
4	Time above 217 °C	Max 30 sec
5	Peak temperature in reflow	230 °C for 10 seconds
6	Temperature gradient in cooling	Max -5 °C/s

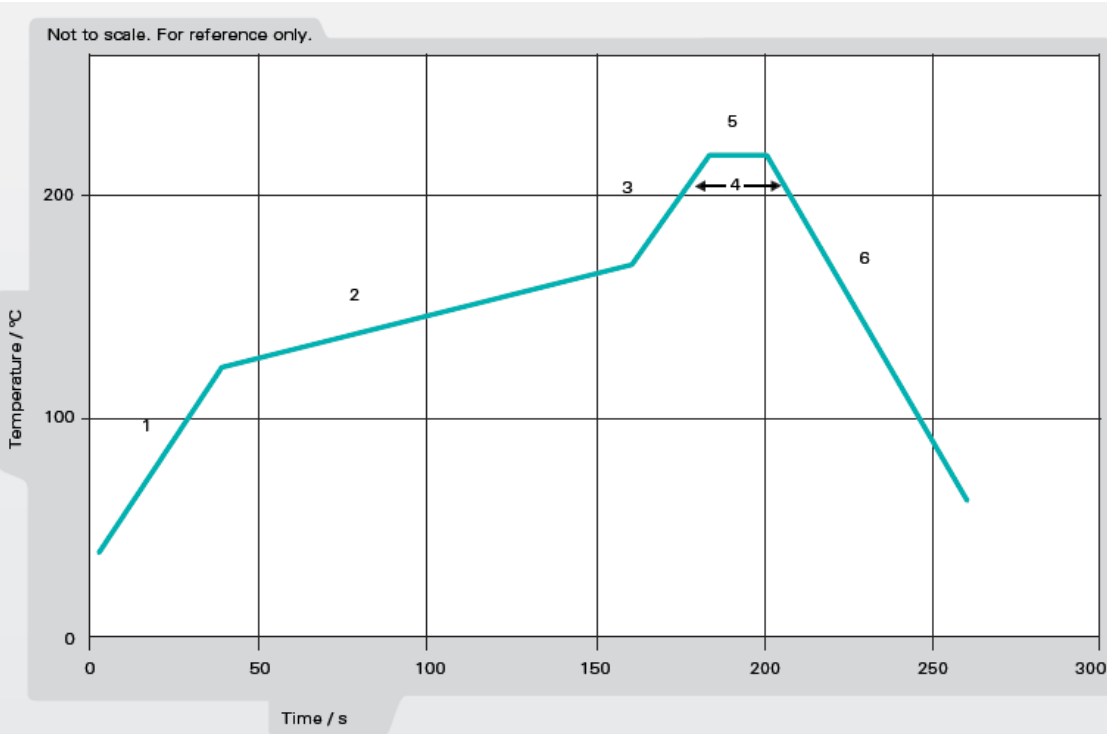
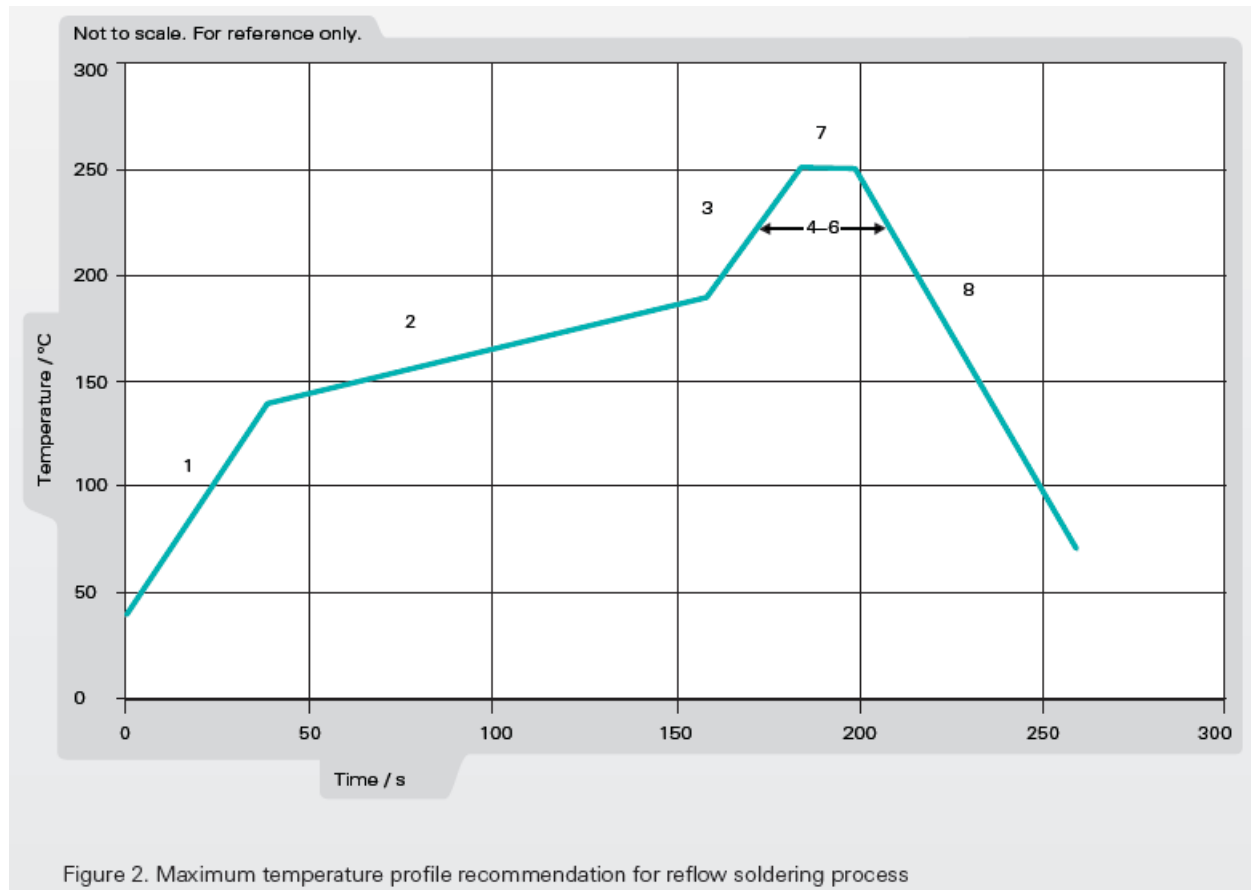

Figure 1. Minimum temperature profile recommendation for reflow soldering process

Recommendation for reflow soldering process

	Method of heat transfer	Controlled hot air convection
1	Average temperature gradient in preheating	2.5 °C/s
2	Soak time	2-3 minutes
3	Max temperature gradient in reflow	3 °C/s
4	Time above 217 °C	Max 60 sec
5	Time above 230 °C	Max 50 sec
6	Time above 250 °C	Max 10 sec
7	Peak temperature in reflow	260 °C for 5 seconds
8	Temperature gradient in cooling	Max -5 °C/s



PACKAGING (TAPE & REEL)

1000pcs Antennas Per 1pcs 13" Tape & Reel
2 pcs 13" Tape & Reel (total 2000pcs Antennas) per 1 box

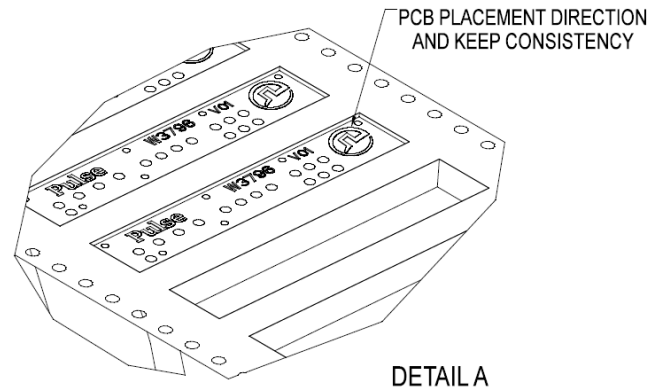
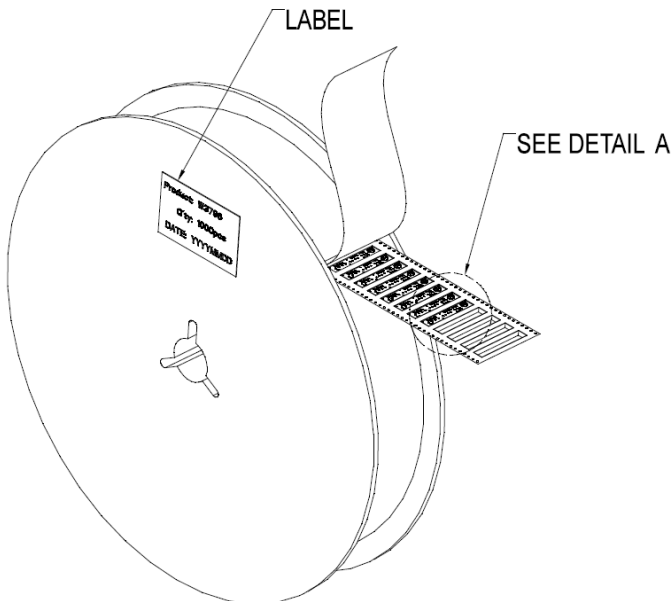
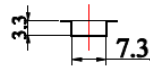
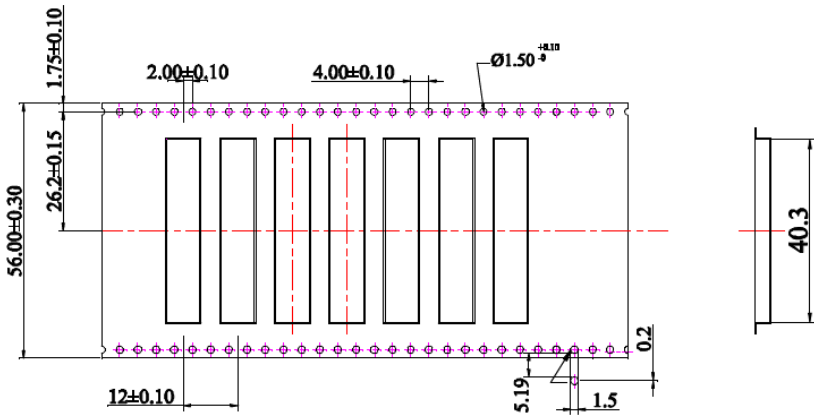

- (1) 13" TAPE & REEL, 1000 PCS/REEL, AND EACH REEL SEALED WITH A VACUUM BAG (075-03363.001)
- (2) 2 REELS OF PRODUCTS(TOTAL 2000PCS PRODUCTS) PACKED IN ONE CARTON.

Issue: 1903

In the effort to improve our products, we reserve the right to make changes judged to be necessary.
CONFIDENTIAL AND PROPRIETARY INFORMATION

This document contains confidential and proprietary information of Pulse Electronics, Inc. (Pulse) and is protected by copyright, trade secret and other state and federal laws. Its receipt or possession does not convey any rights to reproduce, disclose its contents, or to manufacture, use or sell anything it may describe. Reproduction, disclosure or use without specific written authorization of Pulse is strictly forbidden.