

**60V HIGH ACCURACY 1.5A BUCK/BOOST/BUCK-BOOST
LED DRIVER CONVERTER WITH AEC-Q100**

Description

The ZXLD1374 is a 60V LED driver with integrated 1.5A low side switch to drive high current LEDs. It is a multi-topology converter enabling it to operate in Buck, Boost and Buck-boost configurations; efficiently controlling the current of up to 16-series connected LEDs.

The ZXLD1374 is a modified hysteretic converter using a patent pending control scheme providing high output current accuracy in all three topologies. High accuracy dimming is achieved through DC control and high frequency PWM control.

The ZXLD1374 uses two pins for fault diagnosis. A flag output highlights a fault, while the multi-level status pin gives further information on the exact fault.

The ZXLD1374 has been qualified to AEC-Q100 Grade 1 enabling operation in ambient temperatures from -40 to +125°C.

Pin Assignments

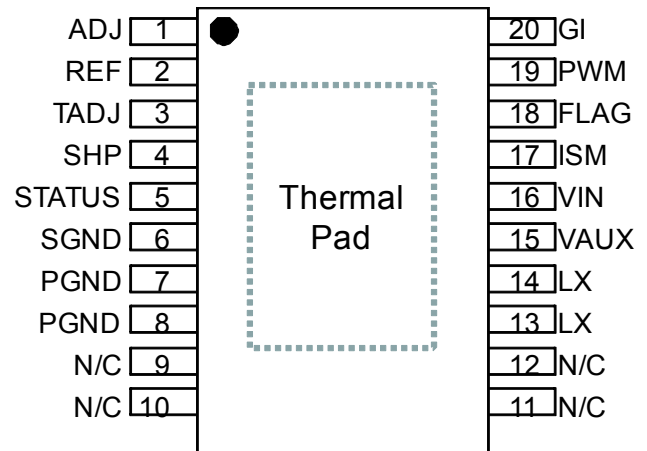

Features

- 0.5% Typical Output Current Accuracy
- 6.3 to 60V Operating Voltage Range
- 1.5A Integrated Low Side Switch
- LED Driver Supports Buck, Boost and Buck-Boost Topologies
- Wide Dynamic Range Dimming
- 20:1 DC Dimming
- 1000:1 Dimming Range at 500Hz
- Up to 1MHz Switching
- High Temperature Control of LED Current Using TADJ
- **AEC-Q100 Grade 1**
- TSSOP-20EP: Available in "Green" Molding Compound (No Br, Sb) with lead Free Finish/ RoHS Compliant
 - **Totally Lead-Free & Fully RoHS Compliant (Notes 1 & 2)**
 - **Halogen and Antimony Free. "Green" Device (Note 3)**

Notes: 1. No purposely added lead. Fully EU Directive 2002/95/EC (RoHS) & 2011/65/EU (RoHS 2) compliant.
 2. See <http://www.diodes.com> for more information about Diodes Incorporated's definitions of Halogen and Antimony free, "Green" and Lead-Free.
 3. Halogen and Antimony free "Green" products are defined as those which contain <900ppm bromine, <900ppm chlorine (<1500ppm total Br + Cl) and <1000ppm antimony compounds.

Typical Applications Circuit

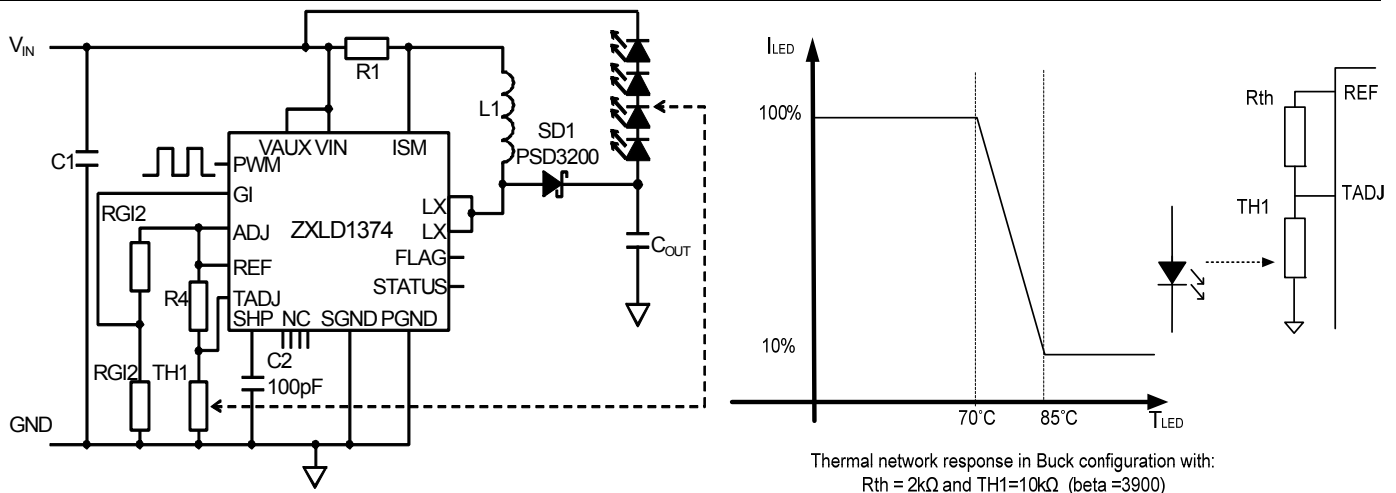

Thermal network response in Buck configuration with:
Rth = 2kΩ and TH1=10kΩ (beta =3900)

Pin Descriptions

Pin Name	Pin	Type (Note 4)	Function
ADJ	1	I	Adjust Input (for DC Output Current Control). Connect to REF to set 100% output current. Drive with dc voltage ($125\text{mV} < V_{\text{ADJ}} < 2.5\text{V}$) to adjust output current from 10% to 200% of set value. The ADJ pin has an internal clamp that limits the internal node to less than 3V. This prevents the LED and power switch from delivering too much current should ADJ get overdriven.
REF	2	O	Internal 1.25V reference voltage output
T _{ADJ}	3	I	Temperature Adjust (Input for LED Thermal Current Control). Connect thermistor/resistor network to this pin to reduce output current above a preset temperature threshold. Connect to REF to disable thermal compensation function (See section on thermal control).
SHP	4	I/O	Shaping capacitor for feedback control loop. Connect 100pF $\pm 20\%$ capacitor from this pin to ground to provide loop compensation
STATUS	5	O	Operation Status Output (analog output). Pin is at 4.5V (nominal) during normal operation. Pin switches to a lower voltage to indicate specific operation warnings or fault conditions (See section on STATUS output). Status pin voltage is low during shutdown mode.
SGND	6	P	Signal Ground. Connect to 0V and pins 7 and 8.
PGND	7, 8	P	Power Ground. Connect to 0V and pin 6 to maximize copper area.
N/C	9, 10, 11, 12	—	Not Connected Internally. To maximize PCB copper for thermal dissipation connect to pins 7 and 8.
LX	13, 14	O	Low-Side Power-Switch Output
V _{AUX}	15	P	Auxiliary Positive Supply to Internal Switch Gate Driver. Connect to V _{IN} , or auxiliary supply from 6V to 15V supply to reduce internal power dissipation (Refer to application section for more details). At V _{IN} > 24V; to reduce power dissipation, V _{AUX} can be connected to a 12V to 15V auxiliary power supply (see Applications section). Decouple to ground with capacitor close to device (refer to Applications section).
V _{IN}	16	P	Input Supply to Device (6.3V to 60V). Decouple to ground with capacitor close to device (refer to Applications section).
ISM	17	I	Current Monitor Input. Connect current sense resistor between this pin and V _{IN} . The nominal voltage, V _{SENSE} , across the resistor is 218mV fixed in Buck mode and initially 225mV in Boost and Buck-Boost modes, varying with duty cycle.
FLAG	18	O	Flag Open Drain Output. Pin is high impedance during normal operation. Pin switches low to indicate a fault, or warning condition.
PWM	19	I	Digital PWM Output Current Control. Pin driven either by open Drain or push-pull 3.3V or 5V logic levels. Drive with frequency higher than 100Hz to gate output 'on' and 'off' during dimming control. The device enters standby mode when PWM pin is driven with logic low level for more than 15ms nominal (Refer to application section for more details).
GI	20	I	Gain Setting Input. Used to set the LED current in Boost and Buck-Boost modes. In Buck mode operation the GI pin must be connected to ADJ. For Boost and Buck-boost modes , connect to resistive divider from ADJ to SGND. This defines the ratio of switch current to LED current (see application section). The GI pin has an internal clamp that limits the internal node to less than 3V. This provides some failsafe should the GI pin get overdriven.
EP	PAD	P	Exposed Pad. Connect to 0V plane for electrical and thermal management.

Note: 4. Type refers to whether or not pin is an Input, Output, Input/Output or Power supply pin.

Functional Block Diagram

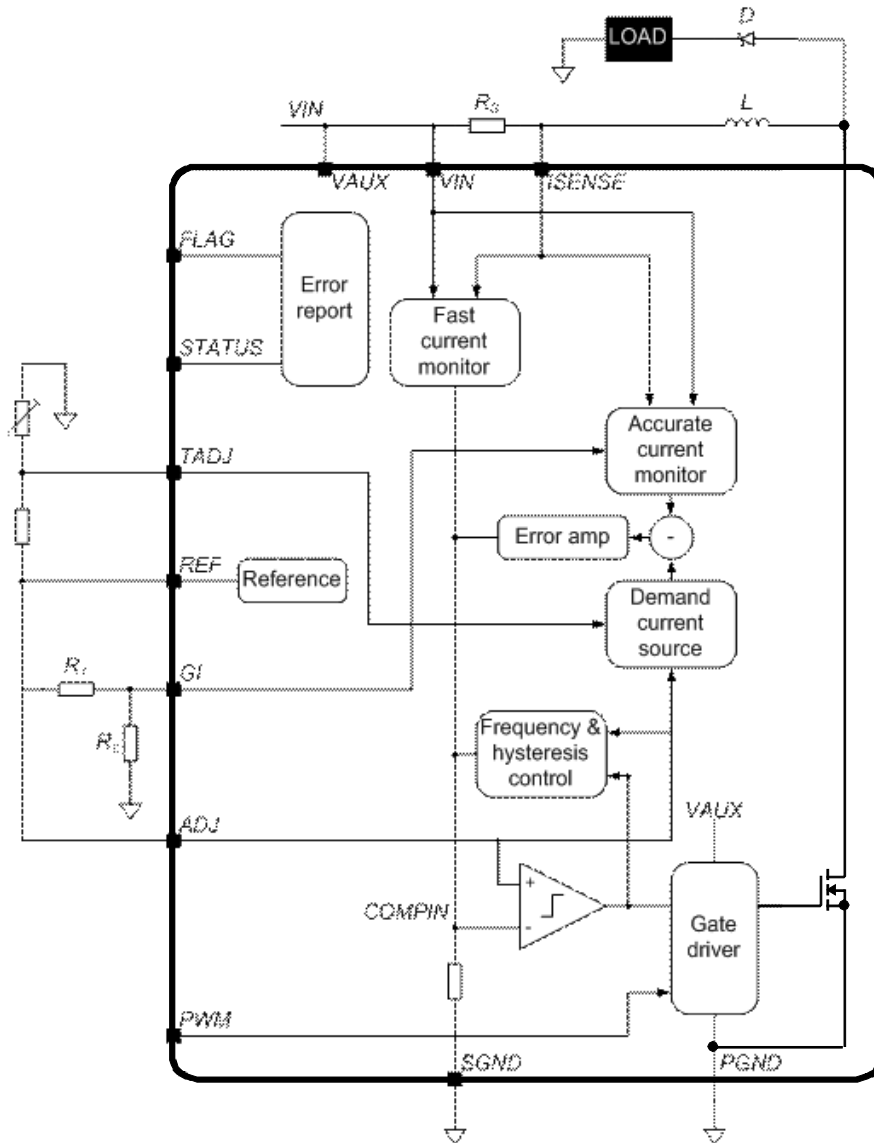

Absolute Maximum Ratings (Voltages to GND unless otherwise specified.)

Symbol	Parameter	Rating	Unit
V_{IN}	Input Supply Voltage Relative to GND [‡]	-0.3 to +65	V
V_{AUX}	Auxiliary Supply Voltage Relative to GND [‡]	-0.3 to +65	V
V_{ISM}	Current Monitor Input Relative to GND [‡]	-0.3 to +65	V
V_{SENSE}	Current Monitor Sense Voltage ($V_{IN}-V_{ISM}$)	-0.3 to +5	V
V_{LX}	Low Side Switch Output Voltage to GND [‡]	-0.3 to +65	V
I_{LX}	Low Side Switch Continuous Output Current	1.8	A
I_{STATUS}	Status Pin Output Current	±1	mA
V_{FLAG}	Flag Output Voltage to GND (Note 5)	-0.3 to +40	V
$V_{PWM}, V_{ADJ}, V_{TADJ}, V_{GI}$	Other Input Pins to GND (Note 5)	-0.3 to +5.5	V
ESD HBM	Human Body Model ESD Protection	500	V
ESD CDM	Charged Device Model ESD Protection	1000	V
T_J	Maximum Junction Temperature	150	°C
T_{ST}	Storage Temperature	-55 to +150	°C

Note: 5. For correct operation SGND and PGND should always be connected together.

These are stress ratings only. Operation outside the absolute maximum ratings may cause device failure.

Operation at the absolute maximum rating for extended periods may reduce device reliability.

Semiconductor devices are ESD sensitive and may be damaged by exposure to ESD events. Suitable ESD precautions should be taken when handling and transporting these devices.

Package Thermal Data

Thermal Resistance	Package		Unit
Junction-to-Ambient, θ_{JA} (Note 6)	TSSOP-20EP	28	°C/W
Junction-to-Case, θ_{JC}		4	°C/W

Note: 6. Measured on High Effective Thermal Conductivity Test Board" according JESD51.

Recommended Operating Conditions (@T_A = +25°C, unless otherwise specified.)

Symbol	Parameter	Performance/Comment	Min	Max	Unit
V _{IN}	Input Supply Voltage Range	Normal operation	8	60	V
		Reduced performance operation (Note 7)	6.3		
V _{AUX}	Auxiliary Supply Voltage Range (Note 8)	Normal operation	8	60	V
		Reduced performance operation (Note 7)	6.3		
V _{SENSE}	Differential Input Voltage	V _{VIN} -V _{ISM} , with 0 ≤ V _{ADJ} ≤ 2.5	0	450	mV
V _{LX}	Low Side Switch Output Voltage			60	V
I _{LX}	Low Side Switch Continuous Output Current			1.5	A
V _{ADJ}	External DC Control Voltage Applied to ADJ Pin to Adjust Output Current	DC brightness control mode from 10% to 200%	0.125	2.5	V
I _{STATUS}	Status Pin Output Current			100	μA
I _{REF}	Reference External Load Current	REF sourcing current		1	mA
f _{SW}	Recommended Switching Frequency Range (Note 9)		300	1000	kHz
V _{TADJ}	Temperature Adjustment (T _{ADJ}) Input Voltage Range		0	V _{REF}	V
f _{PWM}	Recommended PWM Dimming Frequency Range	To maintain 1000:1 resolution	100	500	Hz
		To maintain 200:1 resolution	100	1000	Hz
t _{PWMH/L}	PWM Pulse Width in Dimming Mode	PWM input high or low	0.005	10	ms
V _{PWMH}	PWM Pin High Level Input Voltage		2	5.5	V
V _{PWML}	PWM Pin Low Level Input Voltage		0	0.4	V
T _J	Operating Junction Temperature Range		-40	+125	°C
G _I	Gain Setting Ratio for Boost and Buck-Boost Modes	Ratio= V _{GI} /V _{ADJ}	0.20	0.50	

- Notes:
- Device is guaranteed to have started up by 6.5V and as such the minimum applied supply voltage has to be above 6.5V (plus any noise margin). The ZXLD1374 will, however, continue to function when the input voltage is reduced from ≥ 8V down to 6.3V. When operating with input voltages below 8V the output current and device parameters may deviate from their normal values; and is dependent on power MOSFET switch, load and ambient temperature conditions. To ensure best operation in Boost and Buck-boost modes with input voltages, V_{IN}, between 6.5 and 12V a suitable boot-strap network on V_{AUX} pin is recommended. Performance in Buck mode will be reduced at input voltages (V_{IN}, V_{AUX}) below 8V. – A boot-strap network cannot be implemented in buck mode.
 - V_{AUX} can be driven from a voltage higher than V_{IN} to provide higher efficiency at low V_{IN} voltages, but to avoid false operation; a voltage should not be applied to V_{AUX} in the absence of a voltage at V_{IN}.
 - The device contains circuitry to control the switching frequency to approximately 400kHz. The maximum and minimum operating frequency is not tested.

Electrical Characteristics ($V_{IN} = V_{AUX} = 12V$, @ $T_A = +25^\circ C$, unless otherwise specified.)

Symbol	Parameter	Conditions	Min	Typ	Max	Units
Supply and Reference Parameters						
V_{UV-}	Under-Voltage Detection Threshold Normal Operation to Switch Disabled	V_{IN} or V_{AUX} falling (Note 10)	5.2	5.6	6.3	V
V_{UV+}	Under-Voltage Detection Threshold Switch Disabled to Normal Operation	V_{IN} or V_{AUX} rising (Note 10)	5.5	6	6.5	V
I_{Q-IN}	Quiescent Current into V_{IN}	PWM pin floating. Output not switching		1.5	3	mA
I_{Q-AUX}	Quiescent Current into V_{AUX}			150	300	μA
I_{SB-IN}	Standby Current into V_{IN} .	PWM pin grounded for more than 15ms		90	150	μA
I_{SB-AUX}	Standby Current into V_{AUX} .			0.7	10	μA
V_{REF}	Internal Reference Voltage	No load	1.237	1.25	1.263	V
ΔV_{REF}	Change in Reference Voltage with Output Current	Sourcing 1mA	-5			mV
		Sinking 25 μA			5	
V_{REF_LINE}	Reference Voltage Line Regulation	$V_{IN} = V_{AUX}$, $6.5V < V_{IN} = <60V$	-60	-90		dB
V_{REF-TC}	Reference Temperature Coefficient			+/-50		ppm/ $^\circ C$
DC-DC Converter Parameters						
V_{ADJ}	External DC Control Voltage Applied to ADJ Pin to Adjust Output Current (Note 11)	DC brightness control mode 10% to 200%	0.125	1.25	2.5	V
I_{ADJ}	ADJ Input Current (Note 11)	$V_{ADJ} \leq 2.5V$ $V_{ADJ} = 5.0V$			100 5	nA μA
V_{GI}	GI Voltage Threshold for Boost and Buck-Boost Modes Selection (Note 11)	$V_{ADJ} = 1.25V$			0.8	V
I_{GI}	GI Input Current (Note 11)	$V_{GI} \leq 2.5V$ $V_{GI} = 5.0V$			100 5	nA μA
I_{PWM}	PWM Input Current	$V_{PWM} = 5.5V$		36	100	μA
t_{PWMoff}	PWM Pulse Width (to enter shutdown state)	PWM input low	10	15	25	ms
T_{SDH}	Thermal Shutdown Upper Threshold (LX output inhibited)	Temperature rising		150		$^\circ C$
T_{SDL}	Thermal Shutdown Lower Threshold (LX output re-enabled)	Temperature falling		125		$^\circ C$
High-Side Current Monitor (Pin ISM)						
I_{ISM}	Input Current	Measured into ISM pin and $V_{ISM} = V_{IN}$		11	20	μA
V_{SENSE_acc}	Accuracy of Nominal V_{SENSE} Threshold Voltage	$V_{ADJ} = 1.25V$		± 0.25	± 2	%
$V_{SENSE-OC}$	Over-Current Sense Threshold Voltage		300	350	375	mV

- Notes: 10. UVLO levels are such that all ZXLD1374 will function above 6.5V for rising supply voltages and function down to 6.3V for falling supply voltages.
11. The ADJ and GI pins have an internal clamp that limits the internal node to less than 3V. This limits the switch current should those pins get overdriven.

Electrical Characteristics (cont.) ($V_{IN} = V_{AUX} = 12V$, $@T_A = +25^{\circ}C$, unless otherwise specified.)

Symbol	Parameter	Conditions	Min	Typ	Max	Units
Output Parameters						
V_{FLAGL}	FLAG Pin Low Level Output Voltage	Output sinking 1mA			0.5	V
$I_{FLAGOFF}$	FLAG Pin Open-Drain Leakage Current	$V_{FLAG} = 40V$			1	μA
V_{STATUS}	STATUS Flag No-Load Output Voltage (Note 13)	Normal operation	4.2	4.5	4.8	V
		Out of regulation (V_{SHP} out of range) (Note 12)	3.3	3.6	3.9	
		V_{IN} under-voltage ($V_{IN} < 5.6V$)	3.3	3.6	3.9	
		Switch stalled (t_{ON} or $t_{OFF} > 100\mu s$)	3.3	3.6	3.9	
		LX over-voltage state ($V_{LX} > 60V$)	2.4	2.7	3.0	
		Over-temperature ($T_J > 125^{\circ}C$)	1.5	1.8	2.1	
		Excess sense resistor current ($V_{SENSE} > 0.375V$)	0.6	0.9	1.2	
R_{STATUS}	Output Impedance of STATUS Output	Normal operation		10		k Ω
Low Side Switch Output (LX pins tied together)						
I_{LX-LG}	Low Side Switch Leakage Current	Output stage off, $V_{LX} = 60V$ (Note 14)		60		μA
$R_{DS(ON)}$	LX Pin MOSFET on Resistance	$I_{LX} = 1.5A$ ($t_{ON} < 100\mu s$)		0.5	0.8	Ω
t_{PDHL}	Propagation Delay High-Low	$V_{SENSE} = 225mV \pm 30\%$, $C_L = 680pF$, $R_L = 120\Omega$		86		ns
t_{PDLH}	Propagation Delay Low-High		131		ns	
t_{LXR}	LX Output Rise Time		208		ns	
t_{LXF}	LX Output Fall Time		12		ns	
t_{STALL}	Time to assert 'STALL' flag and warning on STATUS output (Note 15)	LX low or high		100	170	μs
LED Thermal control circuit (TADJ) parameters						
V_{TADJH}	Upper Threshold Voltage	Onset of output current reduction (V_{TADJ} falling)	560	625	690	mV
V_{TADJL}	Lower Threshold Voltage	Output current reduced to <10% of set value (V_{TADJ} falling)	380	440	500	mV
I_{TADJ}	TADJ Pin Input Current	$V_{TADJ} = 1.25V$			1	μA

- Notes:
- Flag is asserted if $V_{SHP} < 2.5V$ or $V_{SHP} > 3.5V$
 - In the event of more than one fault/warning condition occurring, the higher priority condition will take precedence. E.g. 'Excessive coil current' and 'Out of regulation' occurring together will produce an output of 0.9V on the STATUS pin. The voltage levels on the STATUS output assume the Internal regulator to be in regulation and $V_{ADJ} \leq V_{REF}$. A reduction of the voltage on the STATUS pin will occur when the voltage on V_{IN} is near – this is due to the feedback loop increasing the sense voltage.
 - With the device still in switching mode the LX pin has an over-voltage detection circuit connected to it with a resistance of approximately 1M Ω .
 - If t_{ON} exceeds t_{STALL} , LX turns off and then an initiate a restart cycle occurs. During this phase, ADJ is grounded internally and the SHP pin is switched to its nominal operating voltage, before operation is allowed to resume. Restart cycles will be repeated automatically until the operating conditions are such that normal operation can be sustained. If t_{OFF} exceeds t_{STALL} , the switch will remain off until normal operation is possible.

Typical Characteristics

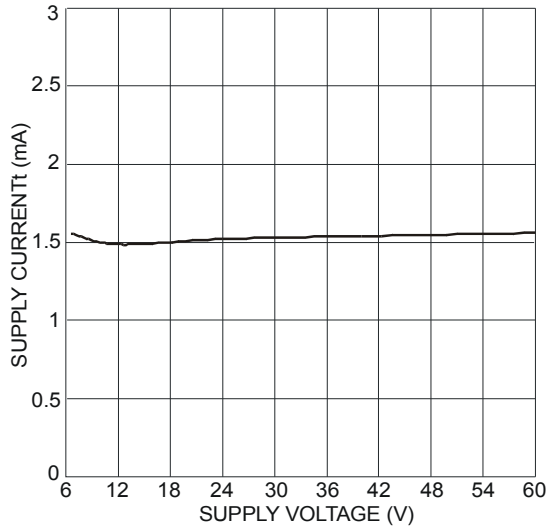

Figure 1 Supply Current vs. Supply Voltage

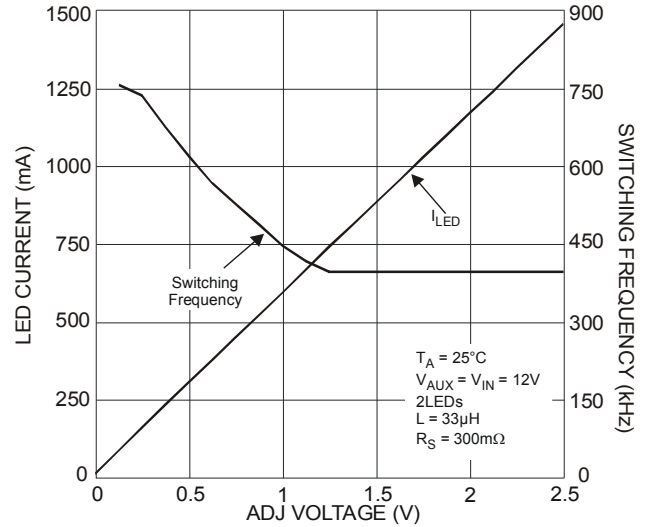

Figure 2 Buck LED Current, Switching Frequency vs. V_{ADJ}

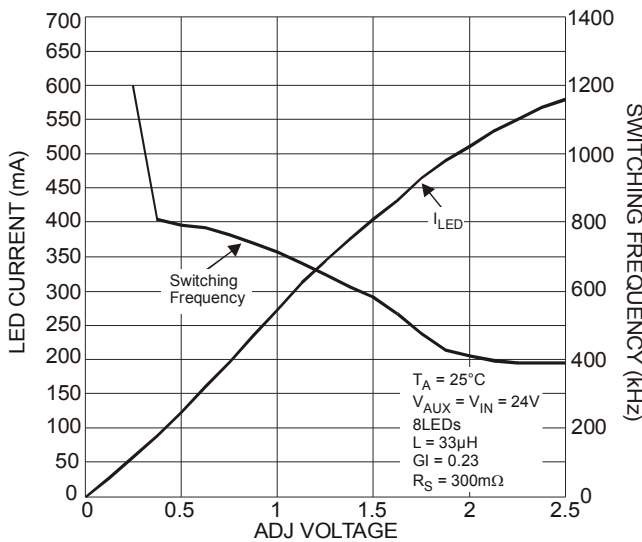

Figure 3 Buck-Boost LED Current, Switching Frequency vs. V_{ADJ}

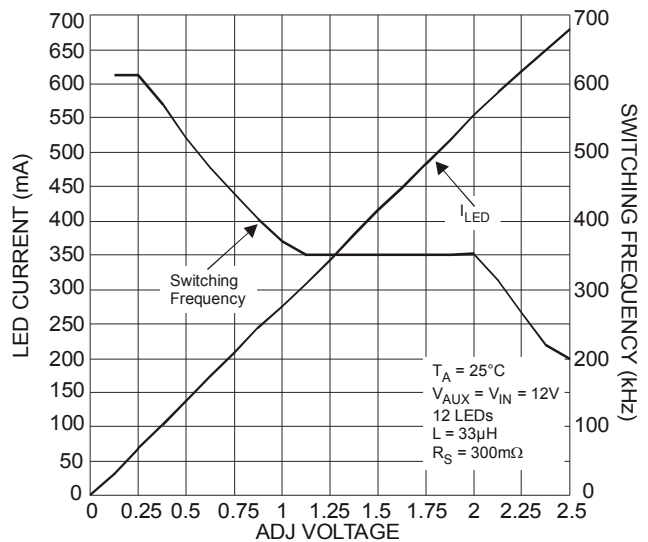

Figure 4 Boost LED Current, Switching Frequency vs. V_{ADJ}

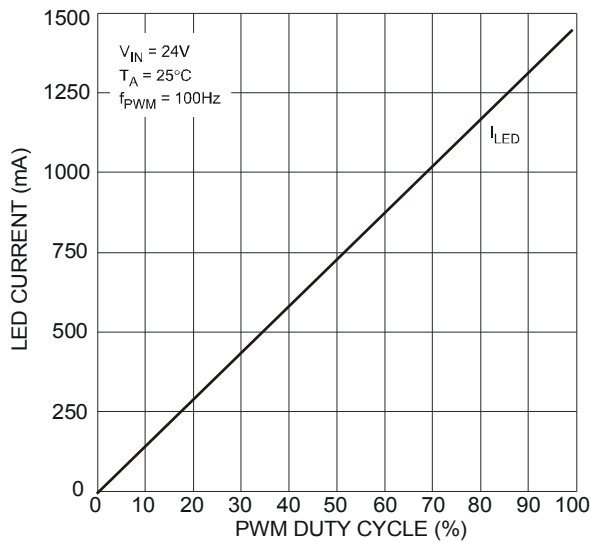

Figure 5 I_{LED} vs. PWM Duty Cycle

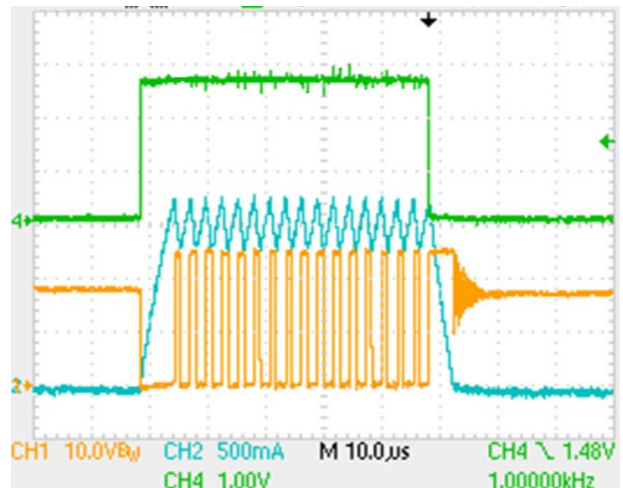

Figure 6 I_{LED} vs. Time - PWM Pin Transient Response

Typical Characteristics (cont.)

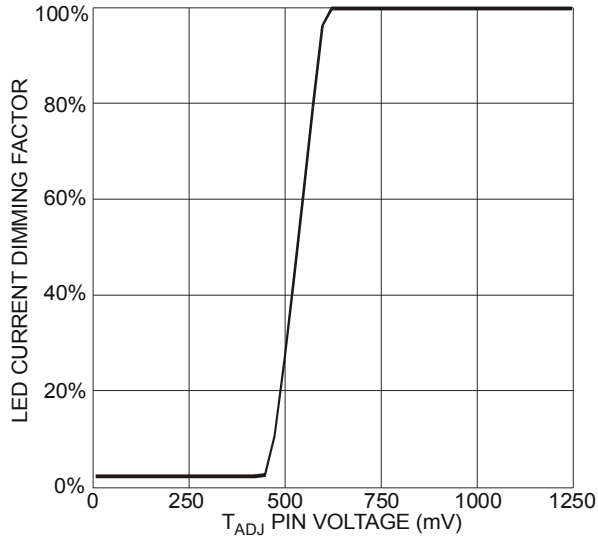

Figure 7 LED Current vs. T_{ADJ} Voltage

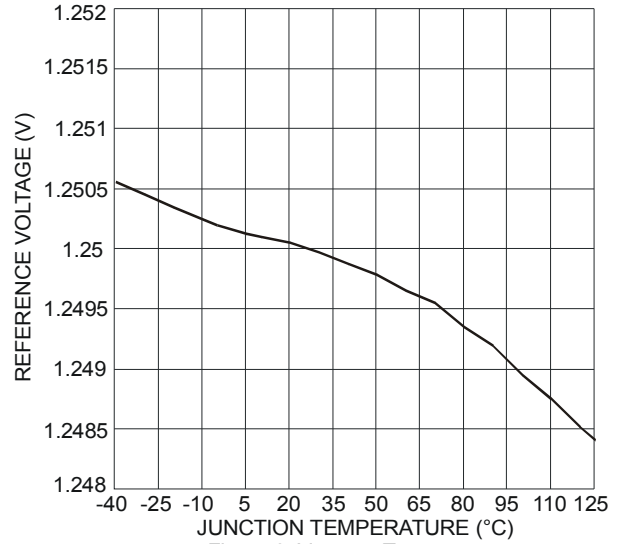

Figure 8 V_{REF} vs. Temperature

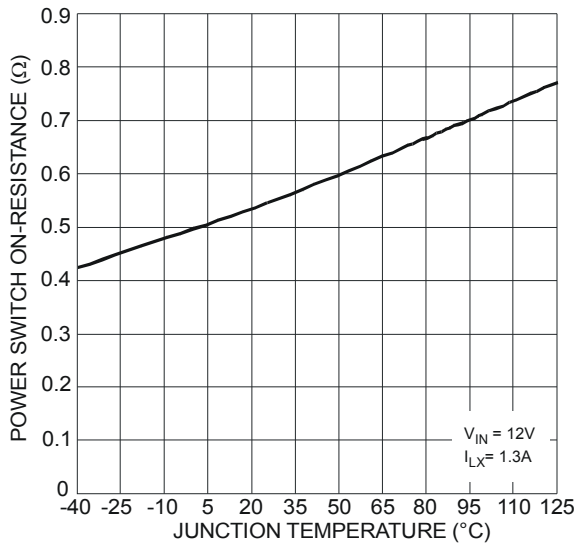

Figure 9 R_{DS(ON)} vs. Temperature

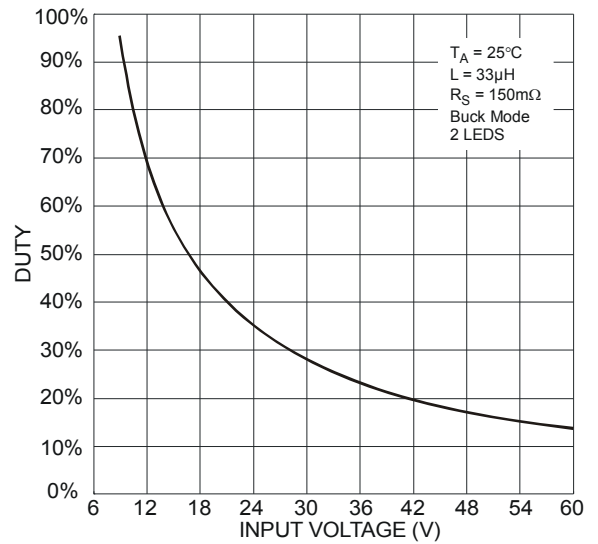

Figure 10 Duty Cycle vs. Input Voltage

Typical Characteristics – Buck Mode – $R_S = 146m\Omega$, $L = 35\mu H$, $I_{LED} = 1.5A$

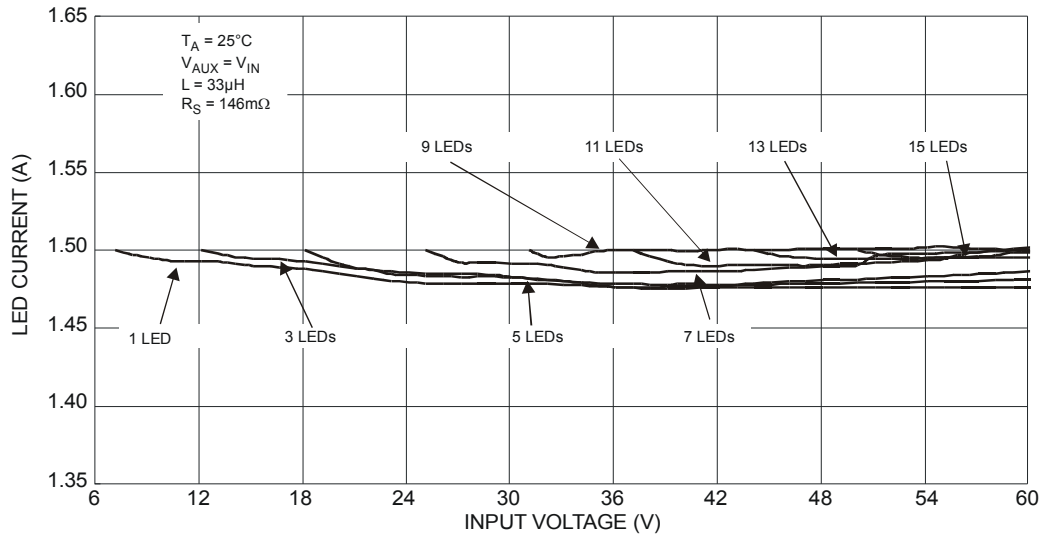

Figure 11 Load Current vs. Input Voltage and Number of LED

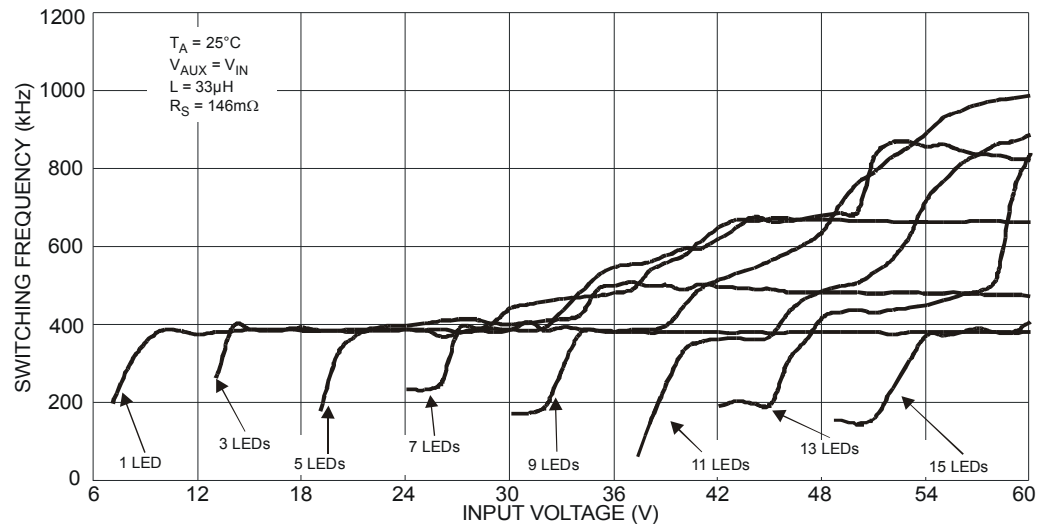

Figure 12 Frequency vs. Input Voltage and Number of LED

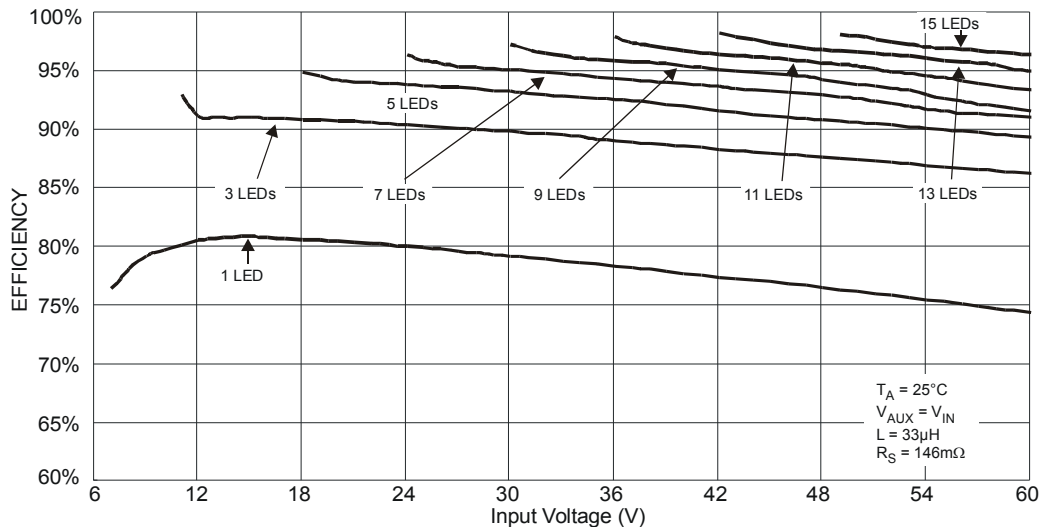

Figure 13 Efficiency vs. Input Voltage and Number of LED

Typical Characteristics – Buck Mode – $R_S = 291m\Omega$, $L = 35\mu H$, $I_{LED} = 750mA$

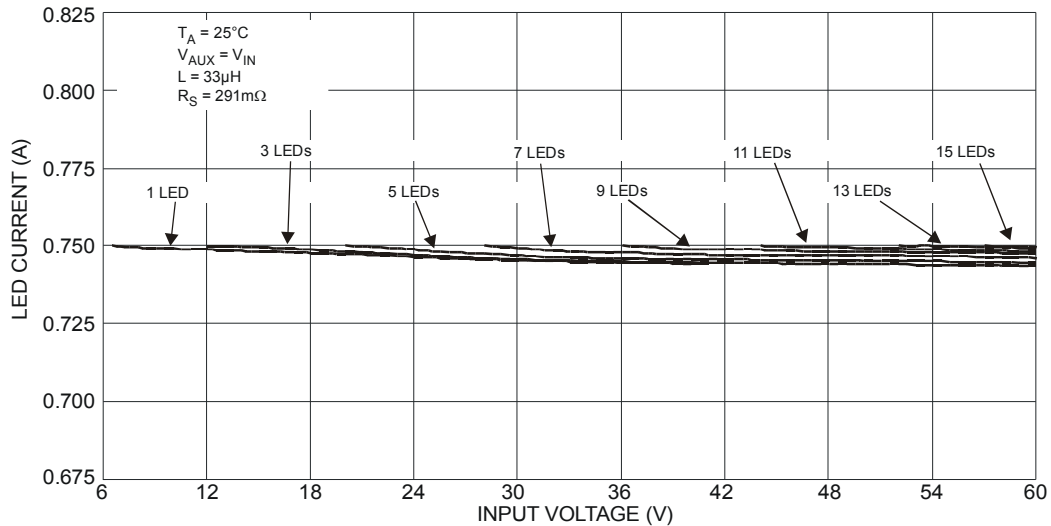

Figure 14 I_{LED} vs. Input Voltage and Number of LED

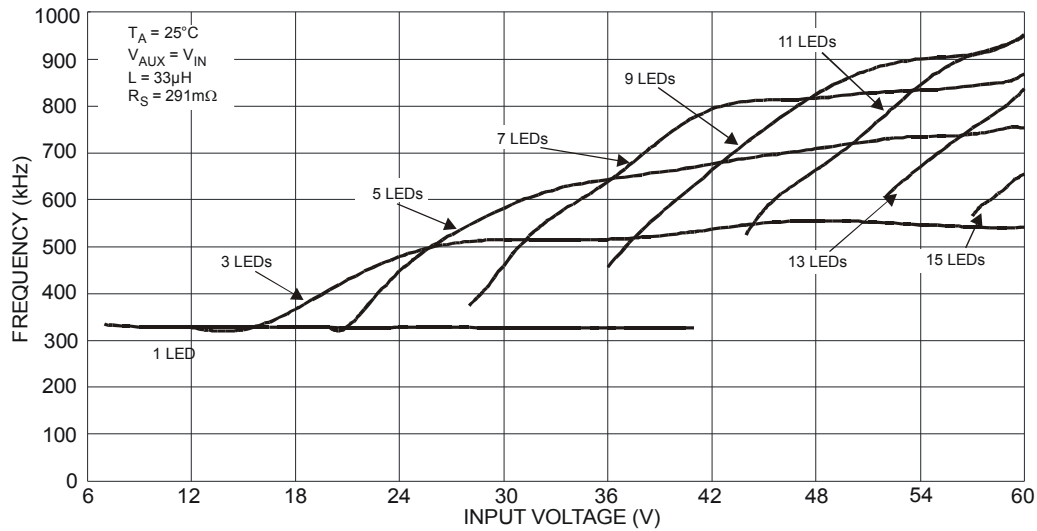

Figure 15 Frequency ZXLD1374 - Buck Mode = $L = 47\mu H$

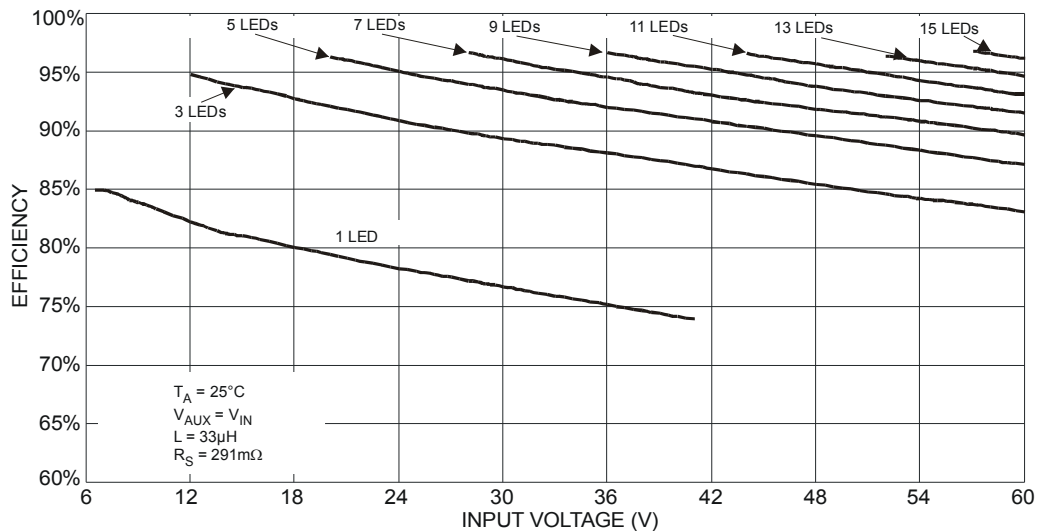

Figure 16 Efficiency vs. Input Voltage and Number of LED

Typical Characteristics – Boost Mode – $R_S = 150m\Omega$, $L = 33\mu H$, $I_{LED} = 325mA$, $G1_{RATIO} = 0.21$

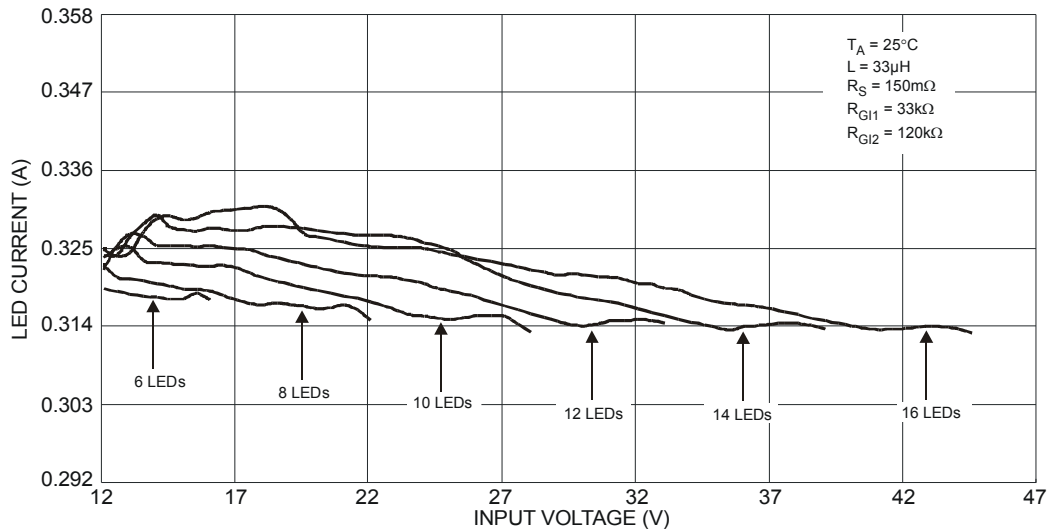

Figure 17 I_{LED} vs. Input and Number of LED

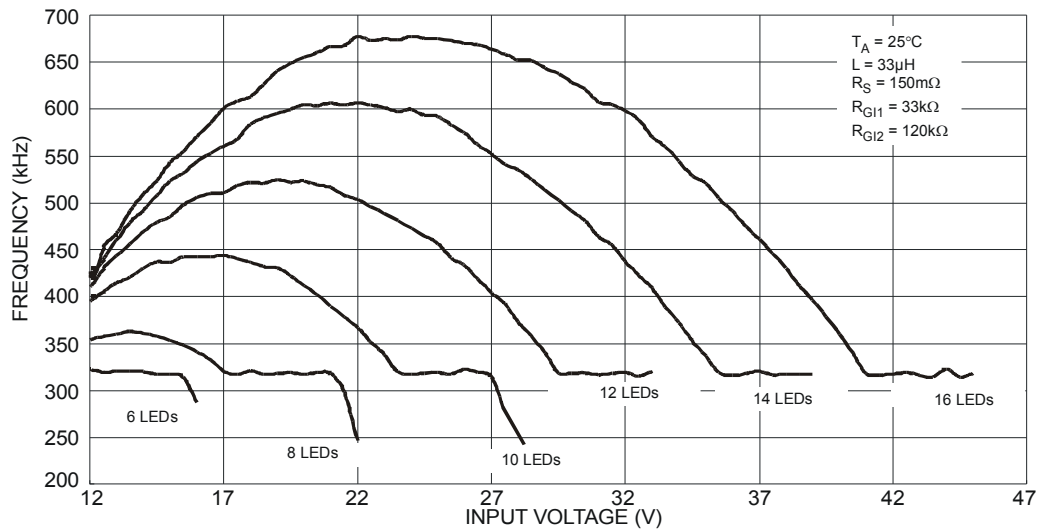

Figure 18 Frequency vs. Input Voltage and Number LED

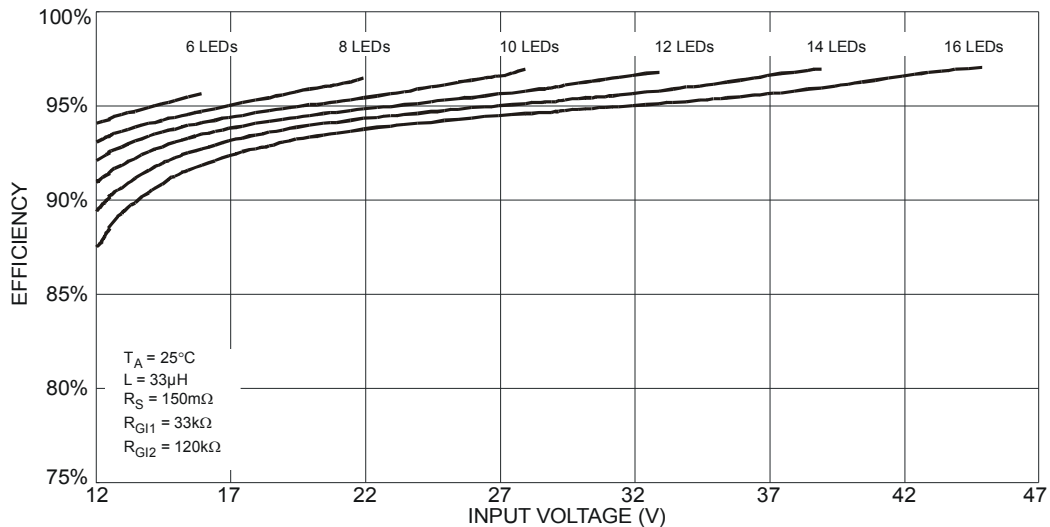

Figure 19 Efficiency vs. Input Voltage and Number of LED

Typical Characteristics – Boost Mode – $R_S = 150\text{m}\Omega$, $L = 33\mu\text{H}$, $I_{LED} = 350\text{mA}$, $G_{IRATIO} = 0.23$ with Bootstrap

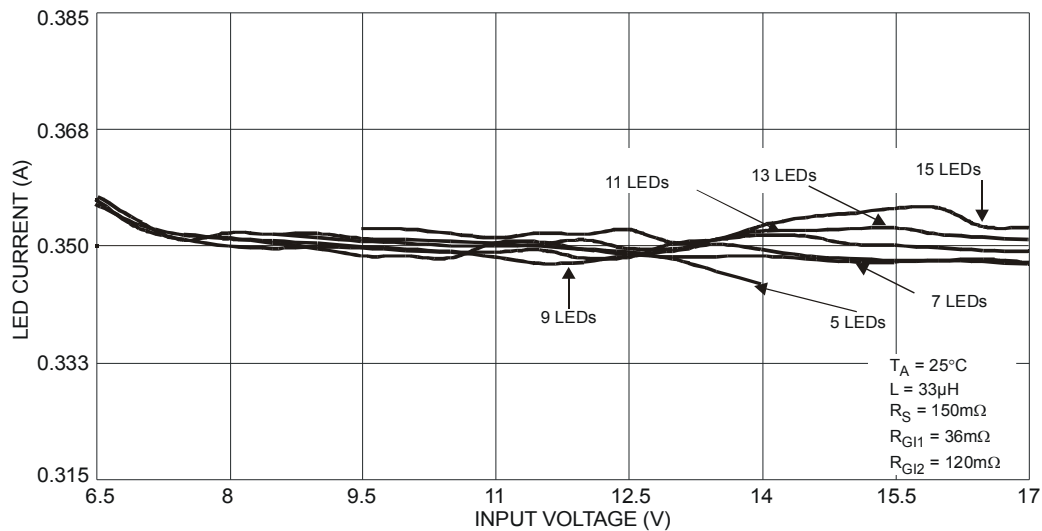

Figure 20 Load Current vs. Input Voltage and Number of LED

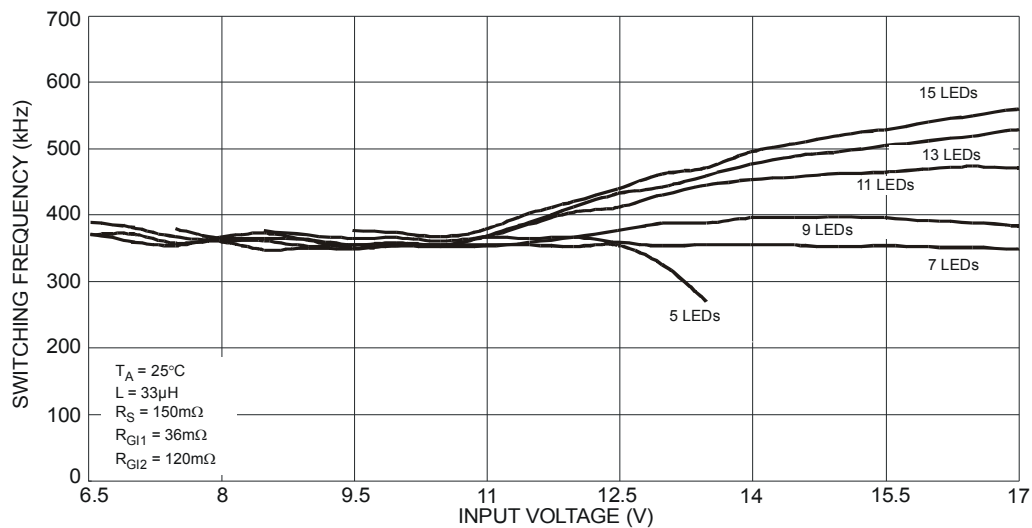

Figure 21 Frequency vs. Input Voltage and Number of LED

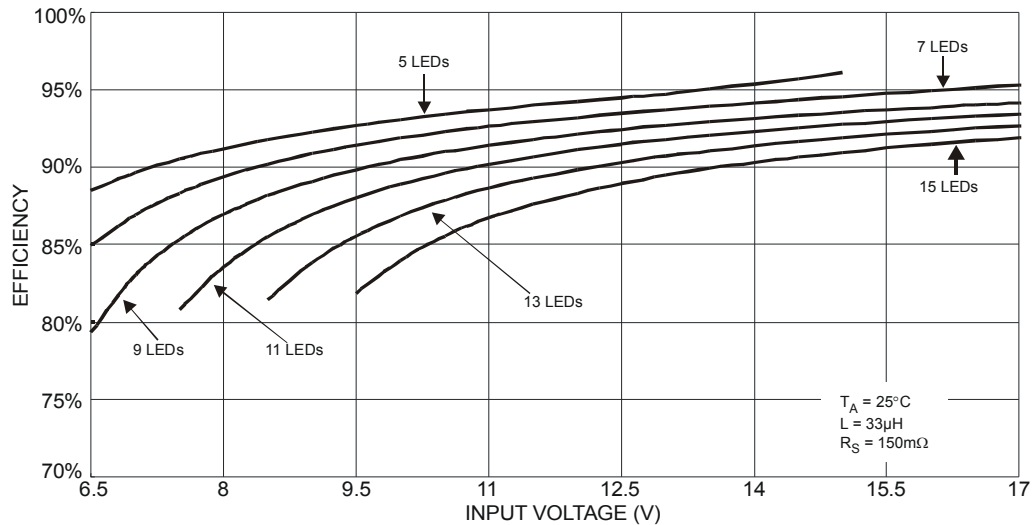

Figure 22 Efficiency vs. Input Voltage and Number of LED

Typical Characteristics – Buck - Boost Mode – $R_S = 150m\Omega$, $L = 33\mu H$, $I_{LED} = 350mA$, $G_{IRATIO} = 0.23$ with Bootstrap

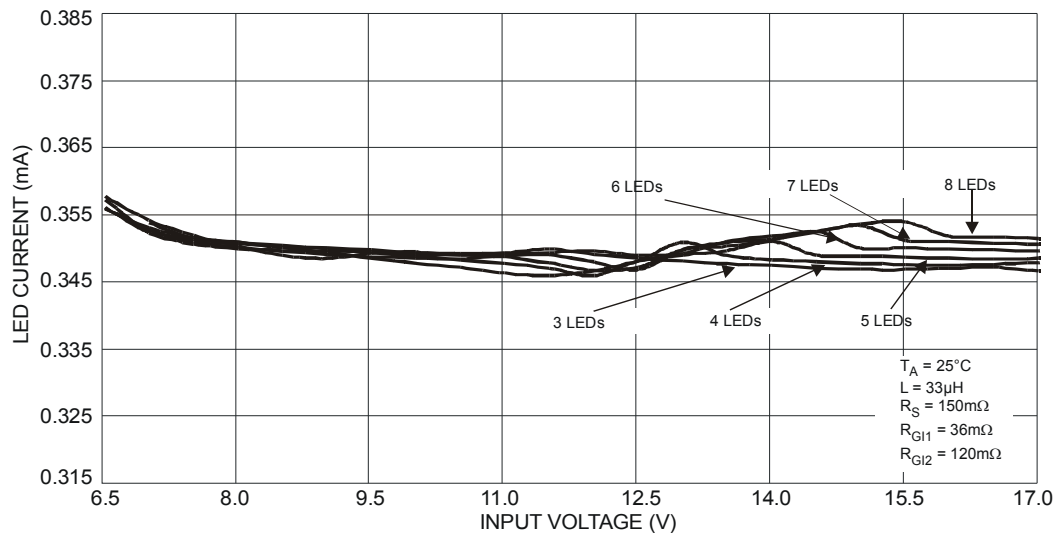

Figure 23 LED Current vs. Input Voltage and Number of LED

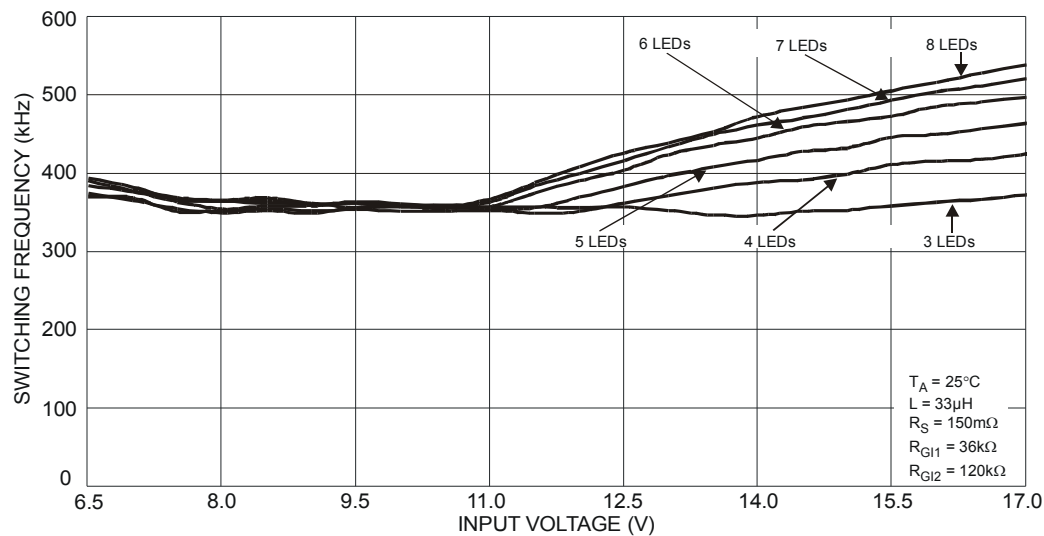

Figure 24 Switching Frequency vs. Input Voltage and Number of LED

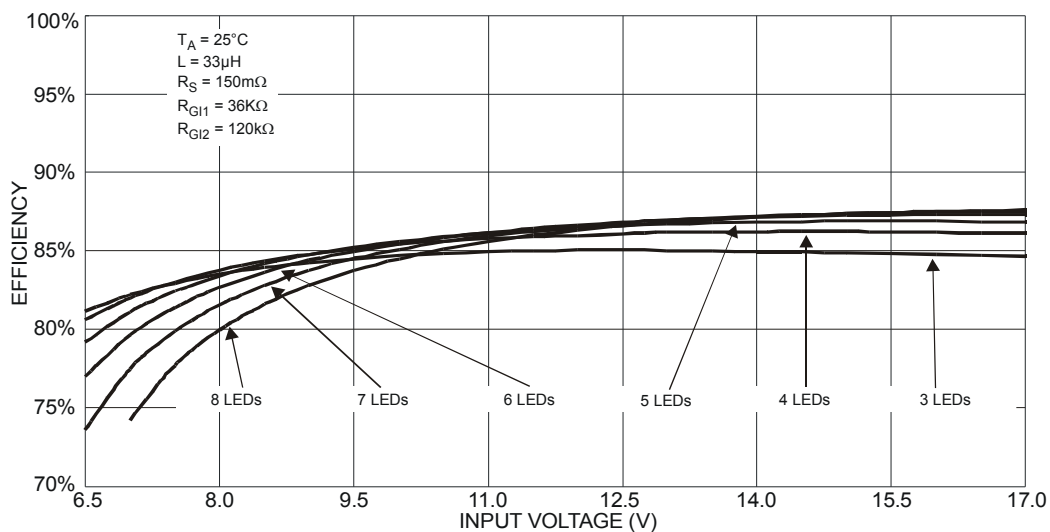

Figure 25 Efficiency vs. Input Voltage and Number of LED

Application Information

The ZXLD1374 is a high accuracy hysteretic inductive Buck/Boost/Buck-boost converter with an internal NMOS switch designed to be used for current-driving single or multiple series-connected LEDs. The device can be configured to operate in Buck, Boost, or Buck-boost modes by suitable configuration of the external components as shown in the schematics shown in the device operation description.

Device Operation

a) Buck Mode

The most simple Buck circuit is shown in Figure 26 LED current control in Buck mode is achieved by sensing the coil current in the sense resistor R_s , connected between the two inputs of a current monitor within the control loop block. An output from the control loop drives the input of a comparator which drives the gate of the internal NMOS switch transistor.

When the switch is on, current flows from V_{IN} , via R_s , LED, coil and switch to ground. This current ramps up until an upper threshold value is reached. At this point the switch is turned off and the current flows via R_s , LED, coil and D1 back to V_{IN} . When the coil current has ramped down to a lower threshold value the switch is turned on again and the cycle of events repeats, resulting in continuous oscillation.

The average current in the LED and coil is equal to the average of the maximum and minimum threshold currents. The ripple current (hysteresis) is equal to the difference between the thresholds.

The control loop maintains the average LED current at the set level by adjusting the thresholds continuously to force the average current in the coil to the value demanded by the voltage on the ADJ pin. This minimizes variation in output current with changes in operating conditions.

The control loop also attempts to minimize changes in switching frequency by varying the level of hysteresis. The hysteresis has a defined minimum (typ 5%) and a maximum (typ 20%), the frequency may deviate from nominal in extreme conditions. Loop compensation is achieved by a single external capacitor C1, connected between SHP and SGND.

The control loop sets the duty cycle so that the sense voltage is

$$V_{SENSE} = 0.218 \left(\frac{V_{ADJ}}{V_{REF}} \right)$$

Therefore,

$$I_{LED} = \left(\frac{0.218}{R_s} \right) \left(\frac{V_{ADJ}}{V_{REF}} \right) \text{ (Buck mode) Equation 1}$$

If the ADJ pin is connected to the REF pin, this simplifies to

$$I_{LED} = \left(\frac{0.218}{R_s} \right) \text{ (Buck mode).}$$

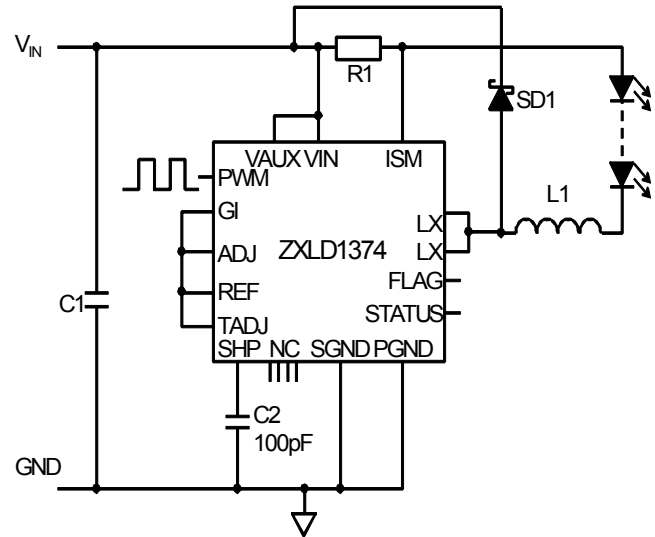

Figure 26 Buck Configuration

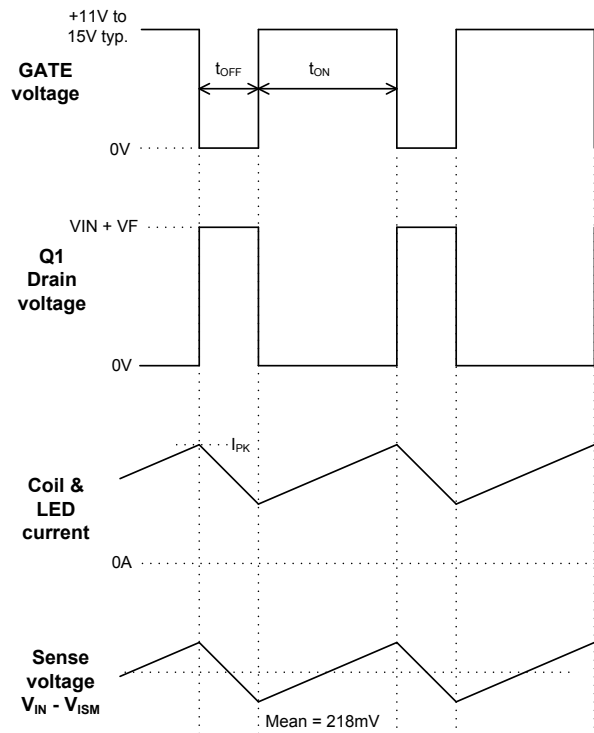

Figure 27 Operating Waveforms (Buck Mode)

Application Information (cont.)

a) Boost and Buck-Boost Modes

A basic ZXLD1374 application circuit for Buck-Boost and Boost modes is shown in Figure 28.

Control in Boost and Buck-boost mode is achieved by sensing the coil current in the series resistor R_s , connected between the two inputs of a current monitor within the control loop block.

An output from the control loop drives the input of a comparator which drives the gate of the internal NMOS switch transistor. In Boost and Buck-boost modes, when the switch is on, current flows from V_{IN} , via R_s , coil and switch to ground. The switch current ramps up until an upper threshold value is reached (see Figure 29). At this point the switch is turned off and the drain voltage increases to either:

- 1) the LED chain voltage plus the forward voltage of D1 in Boost configuration,
- or
- 2) the LED chain voltage plus the forward voltage of D1 plus V_{IN} in Buck-boost configuration.

The inductor current flows via R_s , coil, D1 and LED back to V_{IN} (Buck-boost mode), or GND (Boost mode). When the coil current has ramped down to a lower threshold value the switch is turned on again and the cycle of events repeats, resulting in continuous oscillation.

The feedback loop adjusts the NMOS switch duty cycle to stabilize the LED current in response to changes in external conditions, including input voltage and load voltage. Loop compensation is achieved by a single external capacitor C_2 , connected between SHP and SGND. Note that in reality, a load capacitor C_{OUT} is used, so that the LED current waveform shown is smoothed.

The average current in the coil is equal to the average of the maximum and minimum threshold currents and the ripple current (hysteresis) is equal to the difference between the thresholds. The average current in the LED, I_{LED} , is always less than I_{RS} . The feedback control loop adjusts the switch duty cycle, D , to achieve a set point at the sense resistor. This controls I_{RS} .

During the interval t_{OFF} , the coil current flows through D1 and the LED load.

During t_{ON} , the coil current flows through Q1, not the LEDs. Therefore the set point is modified by D using a gating function to control I_{LED} indirectly. In order to compensate internally for the effect of the gating function, a control factor, G_{I_ADJ} is used. G_{I_ADJ} is set by a pair of external resistors, R_{GI1} and R_{GI2} . (Figure 28.)

This allows the sense voltage to be adjusted to an optimum level for power efficiency without significant error in the LED controlled current.

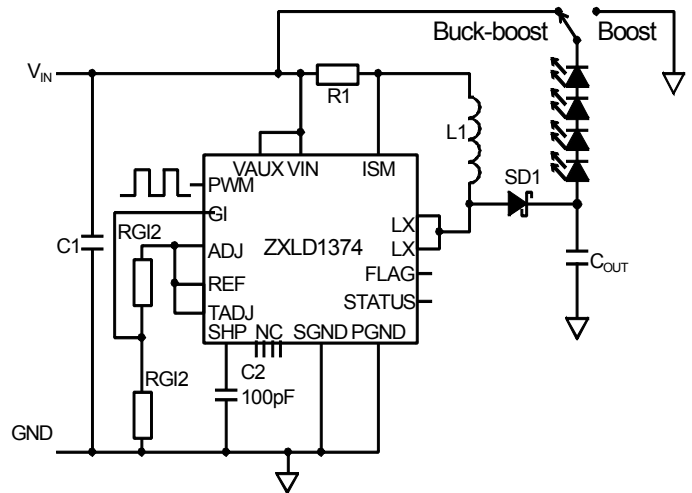

Figure 28 Boost and Buck-Boost Configuration

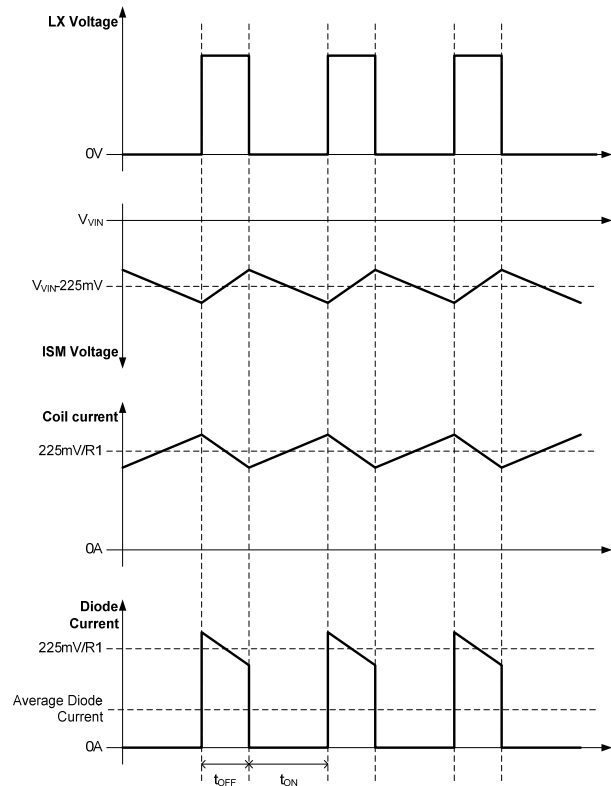

Figure 29 Operating Waveforms (Boost and Buck-Boost Modes)

Application Information (cont.)

$$GI_ADJ = \left(\frac{R_{G1}}{R_{G1} + R_{G2}} \right) \text{ Equation 2 (Boost and Buck-Boost modes)}$$

The control loop sets the duty cycle so that the sense resistor current is

$$I_{RS} = \left(\frac{0.225}{R_S} \right) \left(\frac{GI_ADJ}{1-D} \right) \left(\frac{V_{ADJ}}{V_{REF}} \right) \text{ Equation 3 (Boost and Buck-Boost modes)}$$

I_{RS} equals the coil current. The coil is connected only to the switch and the schottky diode. The schottky diode passes the LED current. Therefore the average LED current is the coil current multiplied by the schottky diode duty cycle, 1-D.

$$I_{LED} = I_{RS} (1-D) = \left(\frac{0.225}{R_S} \right) GI_ADJ \left(\frac{V_{ADJ}}{V_{REF}} \right) \text{ Equation 4 (Boost and Buck-Boost)}$$

This shows that the LED current depends on the ADJ pin voltage, the reference voltage and 3 resistor values (R_S , R_{G1} and R_{G2}). It is independent of the input and output voltages.

If the ADJ pin is connected to the REF pin, this simplifies to

$$I_{LED} = \left(\frac{0.225}{R_S} \right) GI_ADJ \text{ (Boost and Buck-boost)}$$

Now I_{LED} is dependent only on the 3 resistor values.

Considering power dissipation and accuracy, it is useful to know how the mean sense voltage varies with input voltage and other parameters.

$$V_{RS} = I_{RS} R_S = 0.225 \left(\frac{GI_ADJ}{1-D} \right) \left(\frac{V_{ADJ}}{V_{REF}} \right) \text{ Equation 5 (Boost and Buck-boost)}$$

This shows that the sense voltage varies with duty cycle in Boost and Buck-boost configurations.

Application Circuit Designs

External component selection is driven by the characteristics of the load and the input supply, since this will determine the kind of topology being used for the system. Component selection begins with the current setting procedure, the inductor/frequency setting selection. Finally after selecting the freewheeling diode and the output capacitor (if needed), the application section will cover the PWM dimming and thermal feedback. The full procedure is greatly accelerated by the web **Calculator** spreadsheet, which includes fully automated component selection, and is available on the Diodes web site. However the full calculation is also given here.

Please note the following particular feature of the web Calculator. The GI ratio can be set for Automatic calculation, or it can be fixed at a chosen value. When optimizing a design, it is best first to optimize for the chosen voltage range of most interest, using the Automatic setting. In order to subsequently evaluate performance of the circuit over a wider input voltage range, fix the GI ratio in the Calculator input field, and then set the desired input voltage range.

Some components depend upon the switching frequency and the duty cycle. The switching frequency is regulated by the ZXLD1374 to a large extent, depending upon conditions. This is discussed in a later paragraph dealing with coil selection.

Application Information (cont.)

Duty Cycle Calculation and Topology Selection

The duty cycle is a function of the input and output voltages. Approximately, the MOSFET switching duty cycle is

$$\begin{aligned}
 D_{\text{BUCK}} &\approx \frac{V_{\text{OUT}}}{V_{\text{IN}}} && \text{for Buck} \\
 D_{\text{BOOST}} &\approx \frac{V_{\text{OUT}} - V_{\text{IN}}}{V_{\text{OUT}}} && \text{for Boost} \\
 D_{\text{BB}} &\approx \frac{V_{\text{OUT}}}{V_{\text{OUT}} + V_{\text{IN}}} && \text{for Buck-Boost}
 \end{aligned}
 \tag{Equation 6}$$

Because D must always be a positive number less than 1, these equations show that

$$\begin{aligned}
 V_{\text{OUT}} < V_{\text{IN}} &&& \text{for Buck (voltage step-down)} \\
 V_{\text{OUT}} > V_{\text{IN}} &&& \text{for Boost (voltage step-up)} \\
 V_{\text{OUT}} > 0 \text{ or } < V_{\text{IN}} &&& \text{for Buck-boost (voltage step-down or step-up)}
 \end{aligned}$$

This allows us to select the topology for the required voltage range.

More exact equations are used in the web Calculator. These are:

$$\begin{aligned}
 D_{\text{BUCK}} &= \frac{V_{\text{OUT}} + V_{\text{F}} + I_{\text{OUT}}(R_{\text{S}} + R_{\text{COIL}})}{V_{\text{IN}} + V_{\text{F}} - V_{\text{DSON}}} && \text{for Buck} \\
 D_{\text{BOOST}} &= \frac{V_{\text{OUT}} - V_{\text{IN}} + I_{\text{IN}}(R_{\text{S}} + R_{\text{COIL}}) + V_{\text{F}}}{V_{\text{OUT}} + V_{\text{F}} - V_{\text{DSON}}} && \text{for Boost} \\
 D_{\text{BB}} &= \frac{V_{\text{OUT}} + V_{\text{F}} + (I_{\text{IN}} + I_{\text{OUT}})(R_{\text{S}} + R_{\text{COIL}})}{V_{\text{OUT}} + V_{\text{IN}} + V_{\text{F}} - V_{\text{DSON}}} && \text{for Buck-Boost}
 \end{aligned}
 \tag{Equation 7}$$

where V_{F} = schottky diode forward voltage, estimated for the expected coil current, I_{COIL}
 V_{DSON} = MOSFET drain source voltage in the ON condition (dependent on R_{DSON} and drain current = I_{COIL})
 R_{COIL} = DC winding resistance of L1

The additional terms are relatively small, so the exact equations will only make a significant difference at lower operating voltages at the input and output, i.e. low input voltage or a small number of LEDs connected in series. The estimates of V_{F} and V_{DSON} depend on the coil current. The mean coil current, I_{COIL} depends upon the topology and upon the mean terminal currents as follows:

$$\begin{aligned}
 I_{\text{COIL}} &= I_{\text{LED}} && \text{for Buck} \\
 I_{\text{COIL}} &= I_{\text{IN}} && \text{for Boost} \\
 I_{\text{COIL}} &= I_{\text{IN}} + I_{\text{LED}} && \text{for Buck-Boost}
 \end{aligned}
 \tag{Equation 8}$$

I_{LED} is the target LED current and is already known. I_{IN} will be calculated with some accuracy later, but can be estimated now from the electrical power efficiency.

Application Information (cont.)

If the expected efficiency is roughly 90%, the output power P_{OUT} is 90% of the input power, P_{IN} , and the coil current is estimated as follows.

$$P_{OUT} \approx 0.9 P_{IN}$$

or

$$I_{LED} N V_{LED} \approx 0.9 I_{IN} V_{IN}$$

where N is the number of LEDs connected in series, and V_{LED} is the forward voltage drop of a single LED at I_{LED} .

$$\text{So } I_{IN} \approx \frac{I_{LED} N V_{LED}}{0.9 V_{IN}} \quad \text{Equation 9}$$

Equation 9 can now be used to find I_{COIL} in **Equation 8**, which can then be used to estimate the small terms in **Equation 7**. This completes the calculation of Duty Cycle and the selection of Buck, Boost or Buck-boost topology.

An initial estimate of duty cycle is required before we can choose a coil. In **Equation 7**, the following approximations are recommended:

$$\begin{aligned} V_F &= 0.5V \\ I_{IN} \times (R_S + R_{COIL}) &= 0.5V \\ I_{OUT} \times (R_S + R_{COIL}) &= 0.5V \\ V_{DSON} &= 0.1V \\ (I_{IN} + I_{OUT})(R_S + R_{COIL}) &= 1.1V \end{aligned}$$

Then **Equation 7** becomes

$$\begin{aligned} D_{BUCK} &\approx \frac{V_{OUT} + 1}{V_{IN} + 0.4} && \text{for Buck} \\ D_{BOOST} &\approx \frac{V_{OUT} - V_{IN} + 1}{V_{OUT} + 0.4} && \text{for Boost} \\ D_{BB} &\approx \frac{V_{OUT} + 1.6}{V_{OUT} + V_{IN} + 0.4} && \text{for Buck-Boost} \end{aligned} \quad \text{Equation 7a}$$

Setting the LED Current

The LED current requirement determines the choice of the sense resistor R_S . This also depends on the voltage on the ADJ pin and the voltage on the GI pin, according to the topology required.

The ADJ pin may be connected directly to the internal 1.25V reference (V_{REF}) to define the nominal 100% LED current. The ADJ pin can also be driven with an external dc voltage between 125mV and 2.5V to adjust the LED current proportionally between 10% and 200% of the nominal value.

For a divider ratio GI_ADJ greater than 0.65V, the ZXLD1374 operates in Buck mode when $V_{ADJ} = 1.25V$. If GI_ADJ is less than 0.65V (typical), the device operates in Boost or buck-Boost mode, according to the load connection. This 0.65V threshold varies in proportion to V_{ADJ} , i.e., the Buck mode threshold voltage is $0.65 V_{ADJ} / 1.25V$.

ADJ and GI are high impedance inputs within their normal operating voltage ranges. An internal 1.3V clamp protects the device against excessive input voltage and limits the maximum output current to approximately 4% above the maximum current set by V_{REF} if the maximum input voltage is exceeded.

Application Information (cont.)

Buck Topology

In Buck mode, GI is connected to ADJ as in **Figure 30** (for simplicity TADJ is not shown. However if not used should be connected to REF).

The LED current depends only upon R_S , V_{ADJ} and V_{REF} . From **Equation 1** above,

$$R_{SBuck} = \left(\frac{0.218}{I_{LED}} \right) \left(\frac{V_{ADJ}}{V_{REF}} \right) \quad \text{Equation 10}$$

If ADJ is directly connected to V_{REF} , this becomes:

$$R_{SBuck} = \left(\frac{0.218}{I_{LED}} \right)$$

Boost and Buck-Boost Topology

In Boost and Buck-boost mode GI is connected to ADJ through a voltage divider as in figure 31 (for simplicity TADJ is not shown. However if not used should be connected to REF).

The LED current depends upon the resistors, R_S , R_{GI1} , and R_{GI2} as in **Equations 4** and **2** above. There is more than one degree of freedom. That is to say, there is not a unique solution. From **Equation 4**,

$$R_{SBoostBB} = \left(\frac{0.225}{I_{LED}} \right) GI_ADJ \left(\frac{V_{ADJ}}{V_{REF}} \right) \quad \text{Equation 11}$$

If ADJ is connected to REF, this becomes

$$R_{SBoostBB} = \left(\frac{0.225}{I_{LED}} \right) GI_ADJ$$

GI_ADJ is given by **Equation 2**, repeated here for convenience:

$$GI_ADJ = \left(\frac{R_{GI1}}{R_{GI1} + R_{GI2}} \right)$$

Note that from considerations of ZXLD1374 input bias current, the recommended limits for R_{GI1} are:

$$22k\Omega < R_{GI1} < 100k\Omega$$

The additional degree of freedom allows us to select GI_ADJ within limits but this may affect overall performance a little. As mentioned above, the working voltage range at the GI pin is restricted. The permitted range of GI_ADJ in Boost or Buck-boost configuration is

$$0.2 < GI_ADJ < 0.5$$

The mean voltage across the sense resistor is

$$V_{RS} = I_{COIL} R_S$$

Note that if GI_ADJ is made larger, these equations show that R_S is increased and V_{RS} is **increased**. Therefore, for the same coil current, the dissipation in R_S is increased. So, in some cases, it is better to minimize GI_ADJ . However, consider **Equation 5**. If ADJ is connected to REF, this becomes

$$V_{RS} = 0.225 \left(\frac{GI_ADJ}{1-D} \right)$$

This shows that V_{RS} becomes smaller than 225mV if $GI_ADJ < 1 - D$. If also D is small, V_{RS} can become too small. For example if $D = 0.2$, and GI_ADJ is the minimum value of 0.2, then V_{RS} becomes $0.225 * 0.2 / 0.8 = 56.25mV$. This will increase the LED current error due to small offsets in the system, such as mV drop in the copper printed wiring circuit, or offset uncertainty in the ZXLD1371. If now, GI_ADJ is increased to 0.4 or 0.5, V_{RS} is increased to a value greater than 100mV.

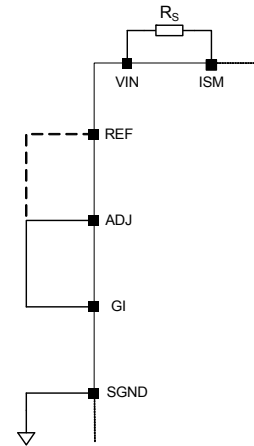

Figure 30 Buck Configuration

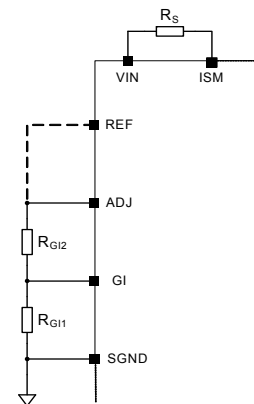

Figure 31 Boost and Buck-Boost Connection

Equation 12

Equation 13

Equation 14

Application Information (cont.)

This will give small enough I_{LED} error for most practical purposes. Satisfactory operation will be obtained if V_{RS} is more than about 80mV. This means GI_ADJ should be greater than $(1-D_{MIN}) * 80/225 = (1-D_{MIN}) * 0.355$.

There is also a maximum limit on V_{RS} which gives a maximum limit for GI_ADJ . If V_{RS} exceeds approximately 300mV, or 133% of 225mV, the STATUS output may indicate an over-current condition. This will happen for larger D_{MAX} . Therefore, together with the requirement of **Equation 13**, the recommended range for GI_ADJ is

$$0.355 (1-D_{MIN}) < GI_ADJ < 1.33 (1-D_{MAX}) \quad \text{Equation 15}$$

An optimum compromise for GI_ADJ has been suggested, i.e.

$$GI_ADJ_{AUTO} = 1 - D_{MAX} \quad \text{Equation 16}$$

This value has been used for the “Automatic” setting of the web Calculator. If $1-D_{MAX}$ is less than 0.2, then GI_ADJ is set to 0.2. If $1-D_{MAX}$ is greater than 0.5 then GI_ADJ is set to 0.5.

Once GI_ADJ has been selected, a value of $RG1$ can be selected from **Equation 12**. Then $RG2$ is calculated as follows, rearranging **Equation 2**:

$$RG2 = RG1 \left(\frac{1 - GI_ADJ}{GI_ADJ} \right) \quad \text{Equation 17}$$

For example to drive 12 LEDs at a current of 350mA from a 12V supply requires Boost configuration. Each LED has a forward voltage of 3.2V at 350mA, so $V_{out} = 3.2 * 12 = 38.4V$. From **Equation 6**, the duty cycle is approximately

$$\frac{(V_{OUT} - V_{IN})}{V_{OUT}} = \frac{(38.4 - 12)}{38.4} = 0.6875$$

From **Equation 16**, we set GI_ADJ to $1 - D = 0.3125$.

If $RG1 = 33k\Omega$, then from **Equation 17**, $RG2 = 33000 * (1 - 0.3125) / 0.3125 = 72.6k\Omega$. Let us choose the preferred value $RG2 = 75k\Omega$. Now GI_ADJ is adjusted to the new value, using **Equation 2**.

$$GI_ADJ = \left(\frac{RG1}{RG1 + RG2} \right) = \frac{33k}{33k + 75k} = 0.305$$

Now we calculate R_s from **Equation 11**. Assume ADJ is connected to REF.

$$R_{SBoostBB} = \left(\frac{0.225}{I_{LED}} \right) GI_ADJ \left(\frac{V_{ADJ}}{V_{REF}} \right) = \frac{0.225}{0.35} * 0.305 = 0.196\Omega$$

A preferred value of $R_{SBoostBB} = 0.2\Omega$ will give the desired LED current with an error of 2% due to the preferred value selection.

Table 1 shows typical resistor values used to determine the GI_ADJ ratio with E24 series resistors.

Table 1

GI Ratio	RG1	RG2
0.2	30k Ω	120k Ω
0.25	33k Ω	100k Ω
0.3	39k Ω	91k Ω
0.35	30k Ω	56k Ω
0.4	100k Ω	150k Ω
0.45	51k Ω	62k Ω
0.5	30k Ω	30k Ω

This completes the LED current setting.

Application Information (cont.)

Inductor Selection and Frequency Control

The selection of the inductor coil, L1, requires knowledge of the switching frequency and current ripple, and also depends on the duty cycle to some extent. In the hysteretic converter, the frequency depends upon the input and output voltages and the switching thresholds of the current monitor. The peak-to-peak coil current is adjusted by the ZXLD1374 to control the frequency to a fixed value. This is done by controlling the switching thresholds within particular limits. This effectively much reduces the overall frequency range for a given input voltage range. Where the input voltage range is not excessive, the frequency is regulated to approximately 390kHz. This is helpful in terms of EMC and other system requirements.

For larger input voltage variation, or when the choice of coil inductance is not optimum, the switching frequency may depart from the regulated value, but the regulation of LED current remains successful. If desired, the frequency can to some extent be increased by using a smaller inductor, or decreased using a larger inductor. The web Calculator will evaluate the frequency across the input voltage range and the effect of this upon power efficiency and junction temperatures.

Determination of the input voltage range for which the frequency is regulated may be required. This calculation is very involved, and is not given here. However the performance in this respect can be evaluated within the web Calculator for the chosen inductance.

The inductance is given as follows in terms of peak-to-peak ripple current in the coil, ΔI_L and the MOSFET on time, t_{ON} .

$$\begin{aligned}
 L1 &= \left\{ V_{IN} - N V_{LED} - I_{OUT} (R_{DS(on)} + R_{COIL} + R_S) \right\} \frac{t_{ON}}{\Delta I_L} && \text{for Buck} \\
 L1 &= \left\{ V_{IN} - I_{IN} (R_{DS(on)} + R_{COIL} + R_S) \right\} \frac{t_{ON}}{\Delta I_L} && \text{for Boost} \\
 L1 &= \left\{ V_{IN} - (I_{IN} + I_{OUT}) (R_{DS(on)} + R_{COIL} + R_S) \right\} \frac{t_{ON}}{\Delta I_L} && \text{for Buck-Boost}
 \end{aligned}
 \tag{Equation 18}$$

Therefore In order to calculate L1, we need to find I_{IN} , t_{ON} , and ΔI_L . The effects of the resistances are small and will be estimated.

I_{IN} is estimated from **Equation 9**.

t_{ON} is related to switching frequency, f, and duty cycle, D, as follows:

$$t_{ON} = \frac{D}{f} \tag{Equation 19}$$

As the regulated frequency is known, and we have already found D from **Equation 7** or the approximation **Equation 7b**, this allows calculation of t_{ON} .

The ZXLD1374 sets the ripple current, ΔI_L , to between nominally 10% and 30% of the mean coil current, I_{COIL} , which is found from **Equation 8**. The device adjusts the ripple current within this range in order to regulate the switching frequency. We therefore need to use a ΔI_L value of 20% of I_{COIL} to find an inductance which is optimized for the input voltage range. The range of ripple current control is also modulated by other circuit parameters as follows.

$$\begin{aligned}
 \Delta I_{LMAX} &= \left\{ 0.06 + 0.24 \left(\frac{V_{ADJ}}{V_{REF}} \right) \right\} \frac{1-D}{GI_ADJ} I_{COIL} \\
 \Delta I_{LMIN} &= \left\{ 0.02 + 0.08 \left(\frac{V_{ADJ}}{V_{REF}} \right) \right\} \frac{1-D}{GI_ADJ} I_{COIL} \\
 \Delta I_{LMID} &= \left\{ 0.04 + 0.16 \left(\frac{V_{ADJ}}{V_{REF}} \right) \right\} \frac{1-D}{GI_ADJ} I_{COIL}
 \end{aligned}
 \tag{Equation 20}$$

If ADJ is connected to REF, this simplifies to

$$\begin{aligned}
 \Delta I_{LMAX} &= 0.3 \frac{1-D}{GI_ADJ} I_{COIL} \\
 \Delta I_{LMIN} &= 0.1 \frac{1-D}{GI_ADJ} I_{COIL} \\
 \Delta I_{LMID} &= 0.2 \frac{1-D}{GI_ADJ} I_{COIL}
 \end{aligned}
 \tag{Equation 20a}$$

where ΔI_{LMID} is the value we must use in **Equation 18**. We have now established the inductance value.

Application Information (cont.)

The chosen coil should saturate at a current greater than the peak sensed current. This saturation current is the DC current for which the inductance has decreased by 10% compared to the low current value.

Assuming $\pm 10\%$ ripple current, we can find this peak current from **Equation 8**, adjusted for ripple current:

$$\begin{array}{ll}
 I_{\text{COILPEAK}} = 1.1 I_{\text{LED}} & \text{for Buck} \\
 I_{\text{COILPEAK}} = 1.1 I_{\text{INMAX}} & \text{for Boost} \\
 I_{\text{COILPEAK}} = 1.1 I_{\text{INMAX}} + I_{\text{LED}} & \text{for Buck-boost}
 \end{array}
 \tag{Equation 21}$$

where I_{INMAX} is the value of I_{IN} at minimum V_{IN} .

The mean current rating is also a factor, but normally the saturation current is the limiting factor.

The following websites may be useful in finding suitable components

www.coilcraft.com

www.niccomp.com

www.wuerth-elektronik.de

Diode Selection

For maximum efficiency and performance, the rectifier (D1) should be a fast low capacitance Schottky diode* with low reverse leakage at the maximum operating voltage and temperature. The Schottky diode also provides better efficiency than silicon PN diodes, due to a combination of lower forward voltage and reduced recovery time.

It is important to select parts with a peak current rating above the peak coil current and a continuous current rating higher than the maximum output load current. In particular, it is recommended to have a voltage rating at least 15% higher than the maximum LX voltage to ensure safe operation during the ringing of the switch node and a current rating at least 10% higher than the average diode current. The power rating is verified by calculating the power loss through the diode.

The higher forward voltage and overshoot due to reverse recovery time in silicon diodes will increase the peak voltage on the LX pin. If a silicon diode is used, care should be taken to ensure that the total voltage appearing on the LX pin, including supply ripple, does not exceed the specified maximum value.

*A suitable Schottky diode would be PDS3100 (Diodes Inc).

Output Capacitor

An output capacitor may be required to limit interference or for specific EMC purposes. For Boost and Buck-boost regulators, the output capacitor provides energy to the load when the freewheeling diode is reverse biased during the first switching subinterval. An output capacitor in a Buck topology will simply reduce the LED current ripple below the inductor current ripple. In other words, this capacitor changes the current waveform through the LED(s) from a triangular ramp to a more sinusoidal version without altering the mean current value.

In all cases, the output capacitor is chosen to provide a desired current ripple of the LED current (usually recommended to be less than 40% of the average LED current).

Buck:

$$C_{\text{OUTPUT}} = \frac{\Delta I_{\text{L-PP}}}{8 \times f_{\text{SW}} \times r_{\text{LED}} \times \Delta I_{\text{LED-PP}}}$$

Boost and Buck-boost

$$C_{\text{OUTPUT}} = \frac{D \times I_{\text{LED}}}{f_{\text{SW}} \times r_{\text{LED}} \times \Delta I_{\text{LED-PP}}}$$

where:

- ΔI_{L} is the ripple of the inductor current, usually $\pm 20\%$ of the average sensed current
- ΔI_{LED} is the ripple of the LED current, it should be $<40\%$ of the LEDs average current
- f_{sw} is the switching frequency (from graphs and calculator)
- r_{LED} is the dynamic resistance of the LEDs string (n times the dynamic resistance of the single LED from the datasheet of the LED manufacturer).

Application Information (cont.)

Output Capacitor (cont.)

The output capacitor should be chosen to account for derating due to temperature and operating voltage. It must also have the necessary RMS current rating. The minimum RMS current for the output capacitor is calculated as follows:

Buck

$$I_{\text{OUTPUT-RMS}} = \frac{I_{\text{LED-PP}}}{\sqrt{12}}$$

Boost and Buck-Boost

$$I_{\text{OUTPUT-RMS}} = I_{\text{LED}} \sqrt{\frac{D_{\text{MAX}}}{1-D_{\text{MAX}}}}$$

Ceramic capacitors with X7R dielectric are the best choice due to their high ripple current rating, long lifetime, and performance over the voltage and temperature ranges.

Input Capacitor

The input capacitor can be calculated knowing the input voltage ripple $\Delta V_{\text{IN-PP}}$ as follows:

Buck

$$C_{\text{IN}} = \frac{Dx(1-D)xI_{\text{LED}}}{f_{\text{SW}} \times \Delta V_{\text{IN-PP}}} \quad \text{use } D = 0.5 \text{ as worst case}$$

Boost

$$C_{\text{IN}} = \frac{\Delta I_{\text{L-PP}}}{8Xf_{\text{SW}} \times \Delta V_{\text{IN-PP}}}$$

Buck-boost

$$C_{\text{IN}} = \frac{DxI_{\text{LED}}}{f_{\text{SW}} \times \Delta V_{\text{IN-PP}}} \quad \text{use } D = D_{\text{MAX}} \text{ as worst case}$$

The minimum RMS current for the output capacitor is calculated as follows:

Buck

$$I_{\text{CIN-RMS}} = I_{\text{LED}} \times \sqrt{Dx(1-D)} \quad \text{use } D = 0.5 \text{ as worst case}$$

Boost

$$I_{\text{CIN-RMS}} = \frac{I_{\text{L-PP}}}{\sqrt{12}}$$

Buck-Boost

$$I_{\text{CIN-RMS}} = I_{\text{LED}} \times \sqrt{\frac{D}{1-D}} \quad \text{use } D = D_{\text{MAX}} \text{ as worst case}$$

Application Information (cont.)

Over-Temperature Shutdown

The ZXLD1374 incorporates an over-temperature shutdown circuit to protect against damage caused by excessive die temperature. A warning signal is generated on the STATUS output when die temperature exceeds +125°C nominal and the output is disabled when die temperature exceeds 150°C nominal. Normal operation resumes when the device cools back down to +125°C.

Flag/Status Outputs

The FLAG/STATUS outputs provide a warning of extreme operating or fault conditions. FLAG is an open-drain logic output, which is normally off, but switches low to indicate that a warning, or fault condition exists. STATUS is a DAC output, which is normally high (4.5V), but switches to a lower voltage to indicate the nature of the warning/fault.

Table 2

Conditions monitored, the method of detection and the nominal STATUS output voltage are given in the following table (Note 15):

Warning/Fault Condition	Severity (Note 16)	Monitored Parameters	FLAG	Nominal STATUS Voltage
Normal Operation			H	4.5V
Supply Under-Voltage	1	$V_{AUX} < 5.6V$	L	4.5V
	2	$V_{IN} < 5.6V$	L	3.6V
Output Current Out of Regulation (Note 17)	2	V_{SHP} outside normal voltage range	L	3.6V
Driver Stalled with Switch 'on', or 'off' (Note 18)	2	t_{ON} , or $t_{OFF} > 100\mu s$	L	3.6V
Switch Over-Voltage	3	LX voltage $> 60V$	L	2.7
Device Temperature Above Maximum Recommended Operating Value	4	$T_J > +125^\circ C$	L	1.8V
Sense Resistor Current I_{RS} Above Specified Maximum	5	$V_{SENSE} > 0.375V$	L	0.9V
Average Switch $> 1.5A$	5	$I_{LX} > 1.5A$	L	0.9V

- Notes:
15. These STATUS pin voltages apply for an input voltage, V_{IN} , of $7.5V < V_{IN} < 60V$. Below 7.5V the STATUS pin voltage levels reduce and therefore may not report the correct status. For $6.3V < V_{IN} < 7.5V$ the flag pin still reports an error by going low. At low V_{IN} in Boost and Buck-boost modes an over-current status may be indicated when operating at high boost ratios — this due to the feedback loop increasing the sense voltage.
 16. Severity 1 denotes lowest severity.
 17. This warning will be indicated if the output power demand is higher than the available input power; the loop may not be able to maintain regulation.
 18. This warning will be indicated if the gate pin stays at the same level for greater than 100 μs (e.g. the output transistor cannot pass enough current to reach the upper switching threshold).

Application Information (cont.)

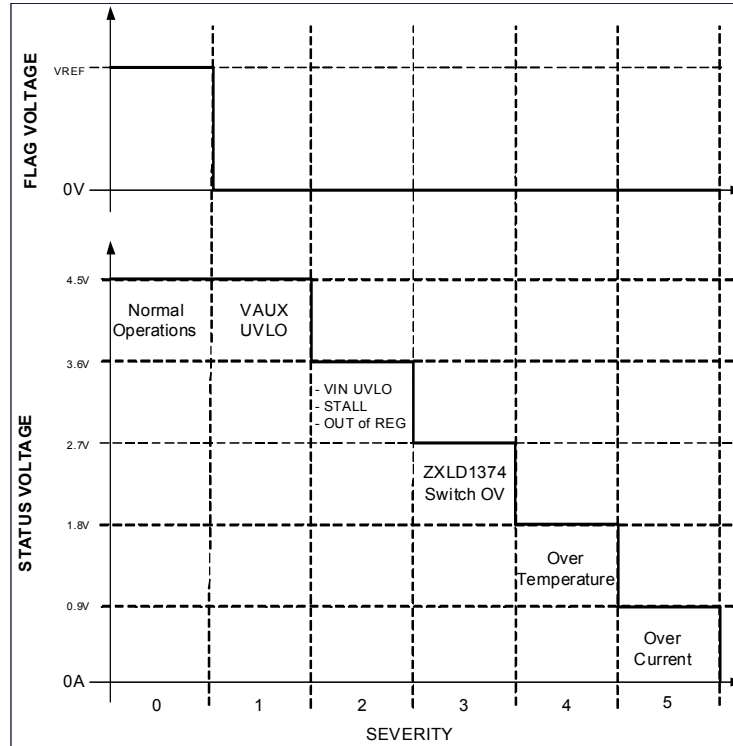

Figure 32 Status Levels

In the event of more than one fault/warning condition occurring, the higher severity condition will take precedence. E.g. ‘Excessive coil current’ and ‘Out of regulation’ occurring together will produce an output of 0.9V on the STATUS pin.

If $V_{ADJ} > 1.7V$, V_{SENSE} may be greater than the excess coil current threshold in normal operation and an error will be reported. Hence, STATUS and FLAG are only guaranteed for $V_{ADJ} \leq V_{REF}$.

Diagnostic signals should be ignored during the device start – up for 100 μ s. The device start up sequence will be initiated both during the first power on of the device or after the PWM signal is kept low for more than 15ms, initiating the standby state of the device.

In particular, during the first 100 μ s the diagnostic is signaling an over-current then an out-of-regulation status. These two events are due to the charging of the inductor and are not true fault conditions.

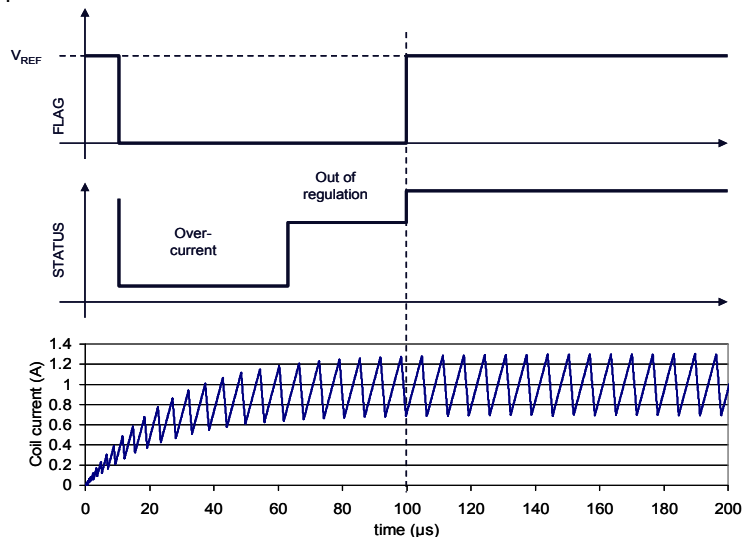

Figure 33 Diagnostic During Start-Up

Application Information (cont.)

Reduced Input Voltage Operation

To facilitate operation in applications that have large transient reductions in system supply voltage, the ZXLD1374 is capable of operating down to input voltages as low as 6.3V. Care must be taken when operating at these lower supply voltages to ensure that the internal MOSFET is correctly enhanced and that the boosting ratio is not increased to excessive amounts where both the duty cycle and peak-switch current limits are not exceeded. The device will operate down to 6.3V, but for reliable start up V_{IN} must be higher than 6.5V plus any margins for any noise that may occur on the supply lines.

In Buck-boost and Boost modes (most common topologies for applications likely to require transient operation down to supply voltages approaching 6V) as the input voltage reduces then the peak switch current will increase the ZXLD1374 compensates for this by allowing the sense voltage to increase while maintaining regulation of the LED current. However if the boost ratio (switch output voltage/input voltage) is increased too much then the sense voltage could be increased too much causing an over-current flag to be triggered and/or loss of regulation.

In addition to this, increased power dissipation will occur in the internal MOSFET switch. One way of overcoming this is to apply a boot-strap network to the V_{AUX} pin – see next section.

If the ZXLD1374 is used in buck mode at low voltages then the boot-strap network cannot be implemented and some loss of regulation may occur at input voltages approaching 6V driving 1 LED.

When using the ZXLD1374 in applications with transient input voltage excursions we recommend using the web calculator to optimize operation over the normal operating band. Then change the input range to include the transient excursion while keeping the optimized component selection to check expected function during the transient input voltage conditions.

Boosting V_{AUX} Supply Voltage in Boost and Buck-Boost Mode

A boot-strap boosting technique can be used to increase the gate drive voltage at low input voltage. See figure 34 for circuit diagram. This can be particularly important for extended use at low input voltages as this is when the switch current will be at its greatest – resulting in greatest heat generation within the MOSFET.

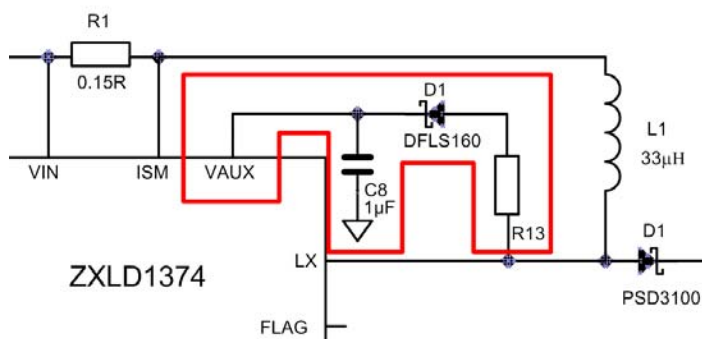

Figure 34. Bootstrap Circuit for Boost and Buck-Boost Low Voltage Operations

The Bootstrap circuit guarantees that the MOSFET is fully enhanced reducing both the power dissipation and the risk of thermal runaway of the MOSFET itself. The bootstrap circuit consists of an extra diode D2 and decoupling capacitor C8 which are used to generate a boosted voltage at V_{AUX} . This enables the device to operate with full output current when V_{IN} is at the minimum value of 6.3V. The resistor R13 can be used to limit the current in the bootstrap circuit in order to reduce the impact of the circuit itself on the LED accuracy. A typical value would be 100 ohms. The impact on the LED current is usually a decrease of maximum 5% compared to the nominal current value set by the sense resistor. The Zener diode may be used to limit the voltage on the V_{AUX} pin to less than 60V.

Due to the increased number of components and the loss of current accuracy, the bootstrap circuit is recommended only when the system has to operate continuously in conditions of low input voltage (between 6.3 and 8V) and high load current.

If lower transient voltages are expected then the ZXLD1371 LED Driver-controller could be used, whose input voltage extends down to 5V.

Application Information (cont.)

Over-Voltage Protection

The ZXLD1374 is inherently protected against open-circuit load when used in Buck configuration. However care has to be taken with open-circuit load conditions in Buck-boost or Boost configurations. This is because in these configurations there is only an over-voltage FLAG but no internal open-circuit protection mechanism for the internal MOSFET. In this case an Over-Voltage-Protection (OVP) network should be provided to the MOSFET to avoid damage due to open circuit conditions. This is shown in **Figure 35** below, highlighted in the dotted blue box.

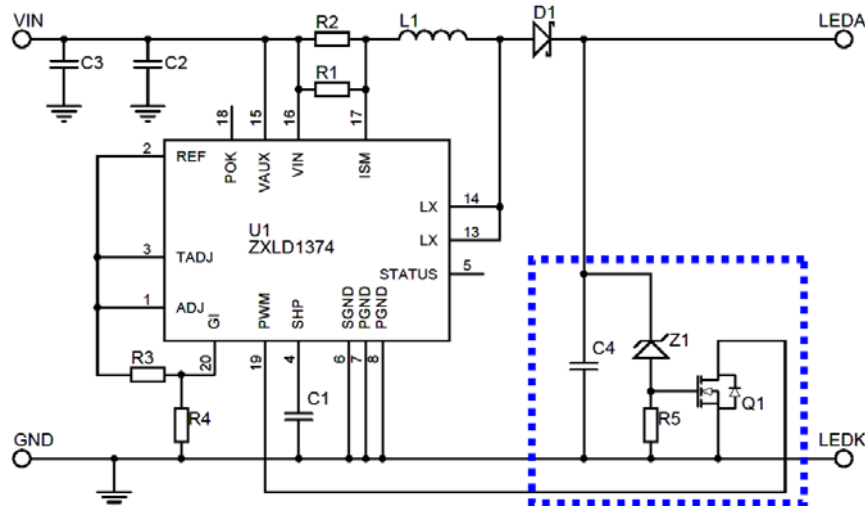

Figure 35 OVP Circuit

The zener voltage is determined according to: $V_Z = V_{LEDMAX} + 10\%$. If the LX pin voltage exceeds V_Z the gate of MOSFET Q1 will rise turning Q1 on. This will pull the PWM pin low and disable the LX output until the voltage on the LX falls below V_Z . If the LX pin remains above V_Z for longer than 20ms then the ZXLD1374 will enter into a shutdown state.

Care should be taken such that the maximum gate voltage of the Q1 MOSFET is not exceeded.

An alternative solution for OVP function is to use the diagnostic section of the ZXLD1374 to initiate the disabling of the LX pin. For example, a microcontroller could be used to respond to the FLAG and the status pins, and if an over-voltage state is indicated, the microcontroller could switch the device off by pulling the PWM signal low.

Application Information (cont.)

LED Current Dimming

The ZXLD1374 has 3 dimming methods for reducing the average LED current

1. Analog dimming using the ADJ pin
2. PWM dimming using the PWM pin
3. Analog dimming for thermal protection using the TADJ pin.

Analog Dimming

The ZXLD1374 has a clamp on the ADJ pin to prevent over-driving of the LED current which results in the maximum voltage being applied to internal circuitry is the reference voltage. This provides a 10:1 dynamic range of dc LED current adjustment.

The equation for DC dimming of the LED current is approximately:

$$I_{LED_DIM} = I_{LED_NOM} \left(\frac{V_{ADJ}}{V_{REF}} \right)$$

Where

I_{LED_DIM} is the dimmed LED current

I_{LED_NOM} is the LED current with $V_{ADJ} = 1.25V$

One consequence of DC dimming is that as the ADJ pin voltage is reduced the sense voltage will also be reduced which has an impact on accuracy and switching frequency especially at lower ADJ pin voltages.

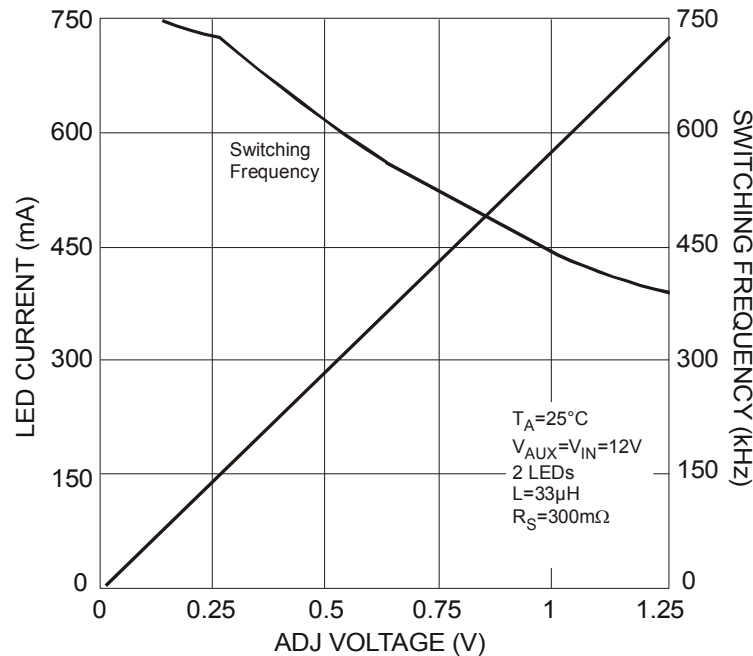

Figure 36 LED Current and Switching Frequency vs. ADJ Voltage

Application Information (cont.)

PWM Output Current Control & Dimming

The ZXLD1374 has a dedicated PWM dimming input that allows a wide dimming frequency range from 100Hz to 1kHz with 1000:1 resolution; however higher dimming frequencies can be used – at the expense of dimming dynamic range and accuracy.

Typically, for a PWM frequency of 1kHz, the error on the current linearity is lower than 5%; in particular the accuracy is better than 1% for PWM from 5% to 100%. This is shown in the graph below for Buck mode:

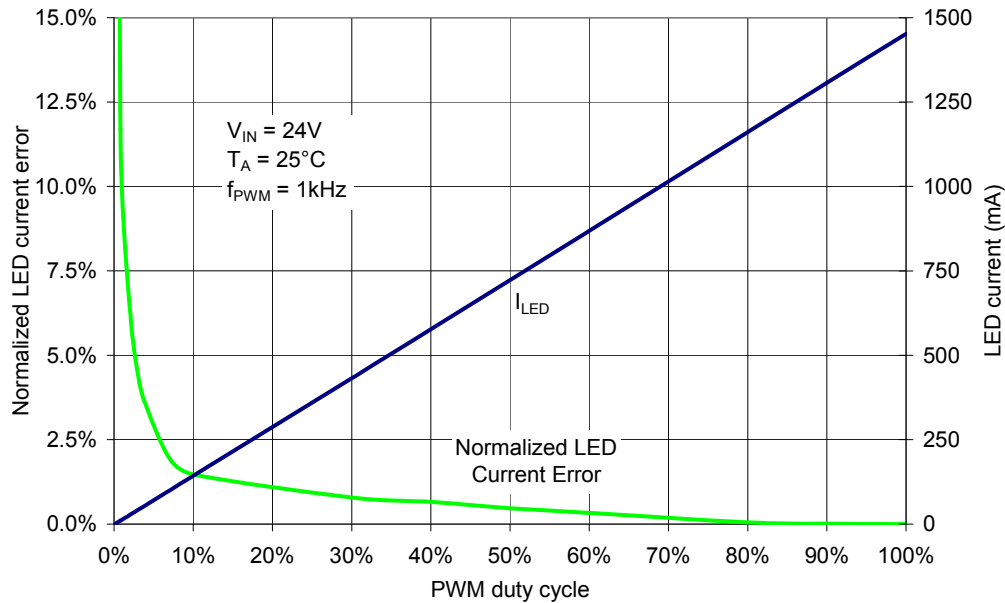

Figure 37 LED Current Linearity and Accuracy with PWM Dimming at 1kHz

For a PWM frequency of 100Hz, the error on the current linearity is lower than 2.5%; it becomes negligible for PWM greater than 5%. This is shown in the graph below:

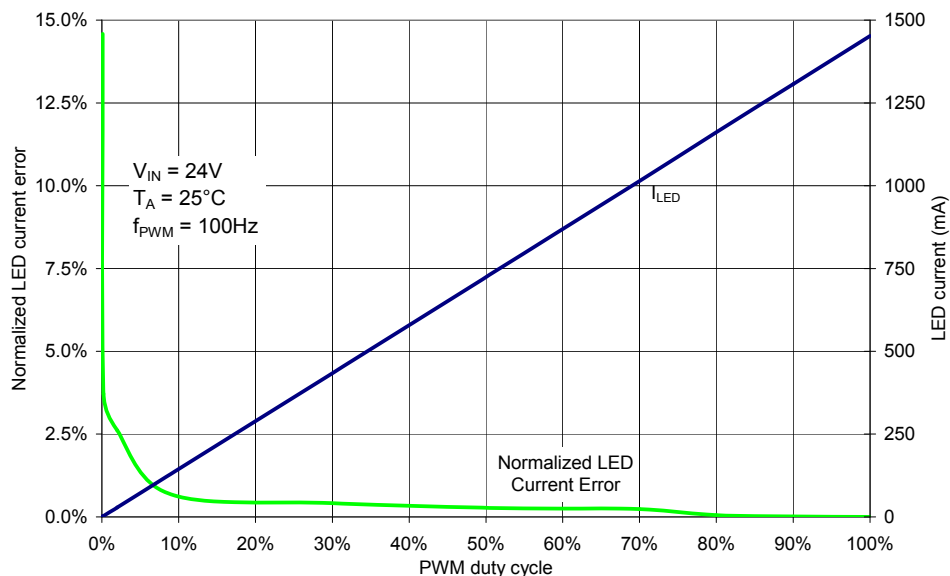

Figure 38 LED Current Linearity and Accuracy with PWM Dimming at 100Hz

Application Information (cont.)

PWM Output Current Control & Dimming (cont.)

The PWM pin is designed to be driven by both 3.3V and 5V logic levels. It can be driven also by an open drain/collector transistor. In this case the designer can either use the internal pull-up network or an external pull-up network in order to speed-up PWM transitions, as shown in the Boost/ Buck-Boost section.

LED current can be adjusted digitally, by applying a low frequency PWM logic signal to the PWM pin to turn the controller on and off. This will produce an average output current proportional to the duty cycle of the control signal. During PWM operation, the device remains powered up and only the output switch is gated by the control signal.

The PWM signal can achieve very high LED current resolution. In fact, dimming down from 100% to 0, a minimum pulse width of 5 μ s can be achieved resulting in very high accuracy. While the maximum recommended pulse is for the PWM signal is 10ms.

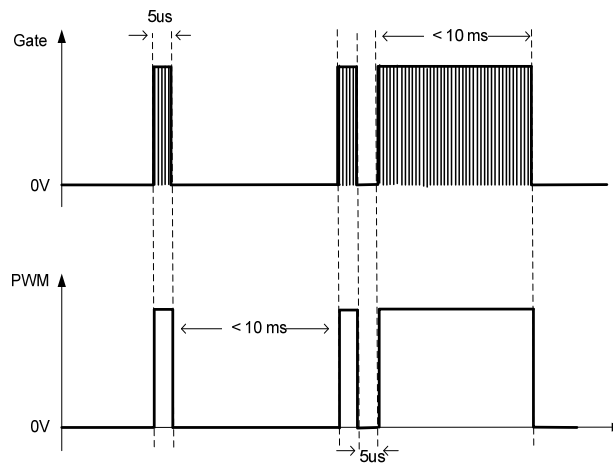

Figure 41 PWM Dimming Minimum and Maximum Pulse

Standby Mode

The device can be put in standby by taking the PWM pin to a voltage below 0.4V for a time exceeding 20ms (15ms nominal). In the shutdown state, most of the circuitry inside the device is switched off and residual quiescent current will be typically 90 μ A. In particular, the Status pin will go down to GND while the FLAG and REF pins will stay at their nominal values.

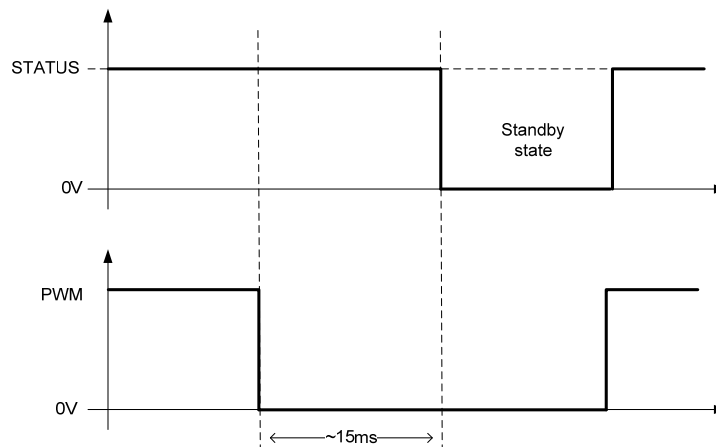

Figure 42 Stand-By State from PWM Signal

Application Information (cont.)

Thermal Control of LED Current

For thermal control of the LEDs, the ZXLD1371 monitors the voltage on the TADJ pin and reduces output current if the voltage on this pin falls below 625mV. An external NTC thermistor and resistor can therefore be connected as shown below to set the voltage on the TADJ pin to 625mV at the required temperature threshold. This will give 100% LED current below the threshold temperature and a falling current above it as shown in the graph. The temperature threshold can be altered by adjusting the value of R_{th} and/or the thermistor to suit the requirements of the chosen LED.

The Thermal Control feature can be disabled by connecting T_{ADJ} to REF.

Here is a simple procedure to design the thermal feedback circuit:

1. Select the temperature threshold $T_{THRESHOLD}$ at which the current must start to decrease
2. Select the Thermistor TH1 (both resistive value at +25°C and beta)
3. Select the value of the resistor R_{TH} as $R_{TH} = TH1$ at $T_{THRESHOLD}$

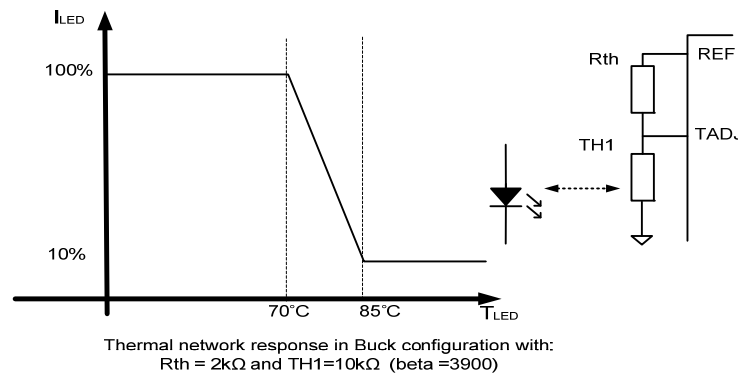

Figure 43 Thermal Feedback Network

For example,

1. Temperature threshold $T_{THRESHOLD} = +70^\circ\text{C}$
2. $TH1 = 10k\Omega$ at 25°C and $\beta = 3500 \rightarrow TH1 = 3.3k\Omega$ at $+70^\circ\text{C}$
3. $R_{TH} = TH1$ at $T_{THRESHOLD} = 3.3k\Omega$

Application Information (cont.)

PCB Layout Considerations

PCB layout is a fundamental activity to get the most of the device in all configurations. In the following section it is possible to find some important insight to design with the ZXLD1374 both in Buck and Buck-Boost/Boost configurations.

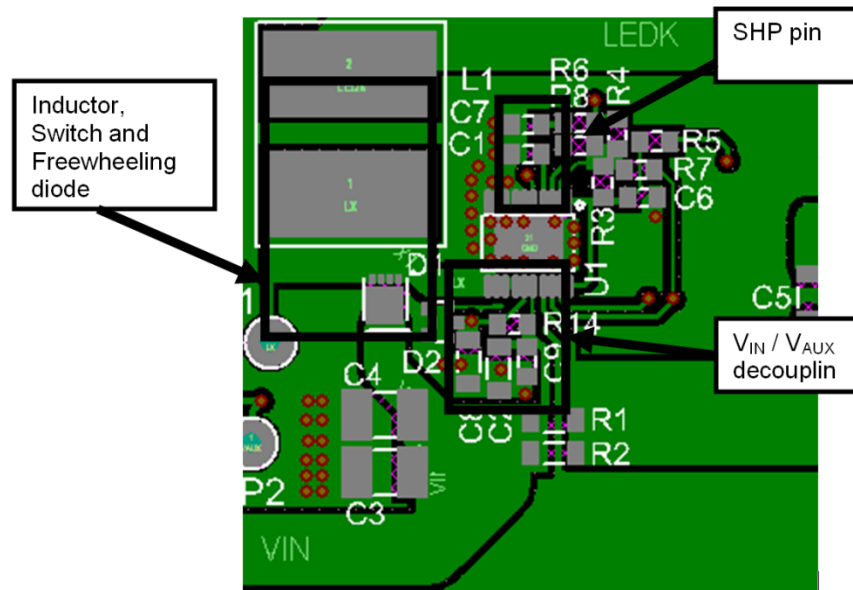

Figure 44 Circuit Layout

Here are some considerations useful for the PCB layout:

- In order to avoid ringing due to stray inductances, the inductor L1, the anode of D1 and the LX pin should be placed as close together as possible.
- The shaping capacitor C1 is fundamental for the stability of the control loop. To this end it should be placed no more than 5mm from the SHP pin.
- Input voltage pins, V_{IN} and V_{AUX} , need to be decoupled. It is recommended to use two ceramic capacitors of $2.2\mu\text{F}$, X7R, 100V (C3 and C4). In addition to these capacitors, it is suggested to add two ceramic capacitors of $1\mu\text{F}$, X7R, 100V each (C2, C8), as well as a further decoupling capacitor of 100nF close to the V_{IN}/V_{AUX} pins (C9) the device is used in Buck mode, or can be driven from a separate supply.
- Ensure that there is a large enough thermal mass to keep the thermal impedance between junction and ambient to keep the ZXLD1374 junction temperature below $+125^\circ\text{C}$. On a 2 layer board this means putting enough vias from the landing pad of the TSSOP-20EP exposed pad through to the bottom layer.

Application Information (cont.)

Thermal Impedance

Below is shown the thermal impedance of the ZXLD1374EST20 on a High Effective Thermal Conductivity Test Board" according JESD51.

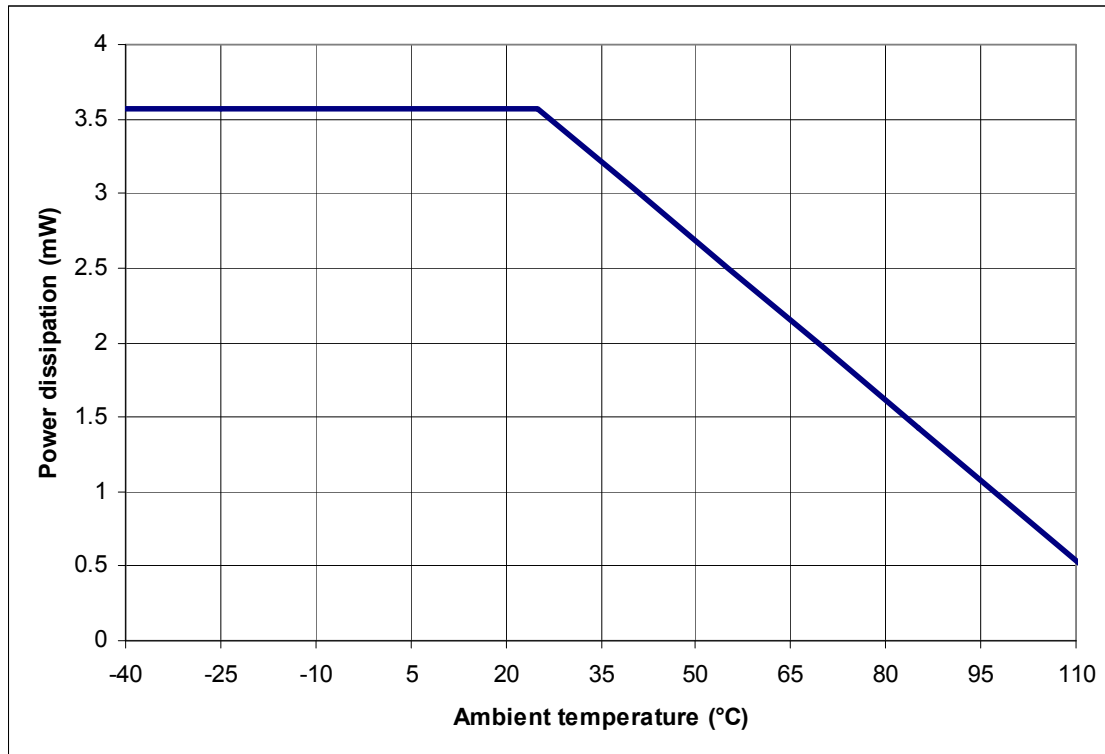

Figure 45 Power Derating Curve

The power dissipation capability of the ZXLD1374 will vary on ambient temperature, effectiveness of any heat sinking, heat generated by components around the ZXLD1374 (inductors, rectifiers, resistors etc) and air flow.

Application Information (cont.)

1.5A Buck LED Driver

In this application example, ZXLD1374 is connected as a Buck LED driver with schematic and parts list shown below. The LED driver is able to deliver 1.5A of LED current to single or multiple LEDs in series with input voltage ranged from 10V to 50V. In order to achieve high efficiency under high LED current, Super Barrier Rectifier (SBR) with low forward voltage is used as free wheeling rectifier.

With only a few extra components, the ZXLD1374 LED driver is able to deliver LED power of greater than 60W. This is suitable for applications which require high LED power likes high power down lighting, wall washer, automotive LED lighting etc.

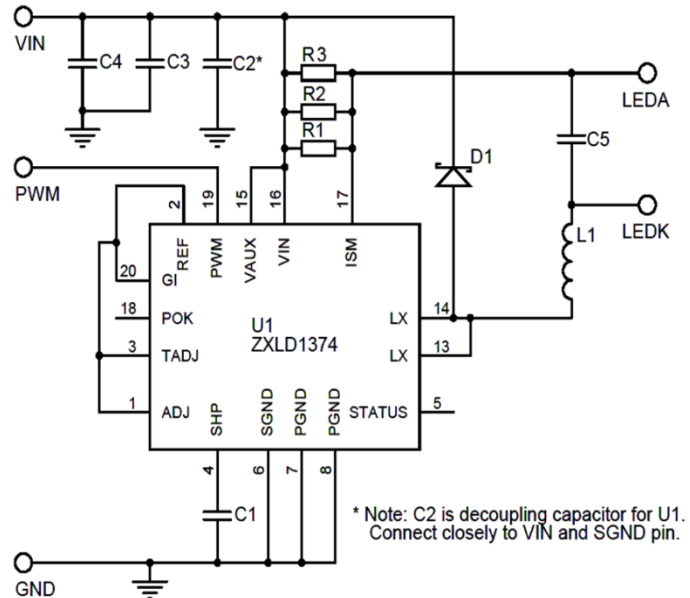

Figure 46 Application Circuit of 1.5A Buck LED Driver

Bill of Material

Ref No.	Value	Part No.	Manufacturer
U1	60V 1.5A LED driver	ZXLD1374	Diodes Inc
D1	100V 3A SBR	SBR3U100	Diodes Inc
L1	33μH 4.2A	744770933	Wurth Elektronik
C1	100pF 50V	SMD 0805/0603	Generic
C2	1μF 100V X7R	SMD1206	Generic
C3 C4 C5	2.2μF 100V X7R	SMD1210	Generic
R1 R2	300mΩ 1%	SMD1206	Generic
R3	4.7Ω	SMD1206	Generic

Typical Performance

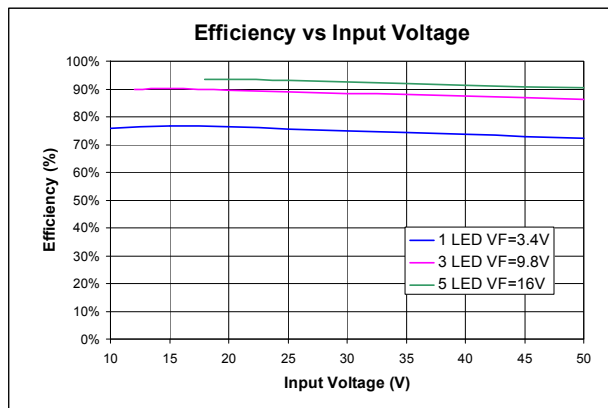

Figure 47 Efficiency

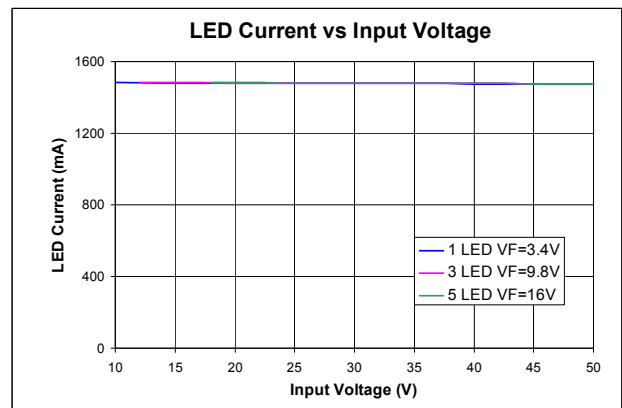

Figure 48 Line Regulation

Application Information (cont.)

350mA Boost LED Driver

In this application example, ZXLD1374 is connected as a Boost LED driver with schematic and parts list shown below. The LED driver is able to deliver 350mA of LED current into 12 high brightness LED with input voltage ranged from 16V to 28V.

Overall high efficiency of 92%+ make it ideal for applications likes solar LED street lighting and general LED illuminations.

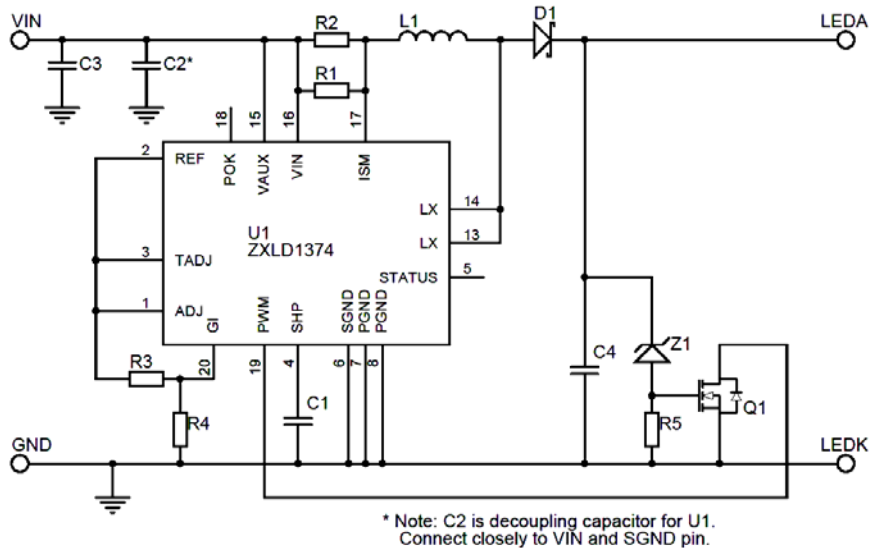

Figure 49 Application Circuit of 350mA Boost LED Driver

Bill of Material

Ref No.	Value	Part No.	Manufacturer
U1	60V LED driver	ZXLD1374	Diodes Inc
Q1	60V MOSFET	2N7002A	Diodes Inc
D1	100V 3A Schottky	PDS3100-13	Diodes Inc
Z1	51V 410mW Zener	BZT52C51	Diodes Inc
L1	47µH 2.6A	744771147	Wurth Electronik
C1	100pF 50V	SMD 0805/0603	Generic
C3 C4	4.7µF 100V X7R	SMD1210	Generic
C2	1µF 50V X7R	SMD1206	Generic
R1 R2	300mΩ 1%	SMD1206	Generic
R3	120kΩ 1%	SMD 0805/0603	
R4	36kΩ 1%	SMD 0805/0603	Generic
R5	2.7kΩ	SMD 0805/0603	Generic

Typical Performance

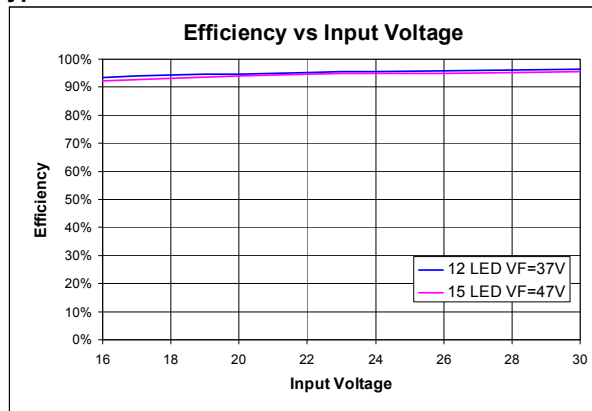

Figure 50 Efficiency

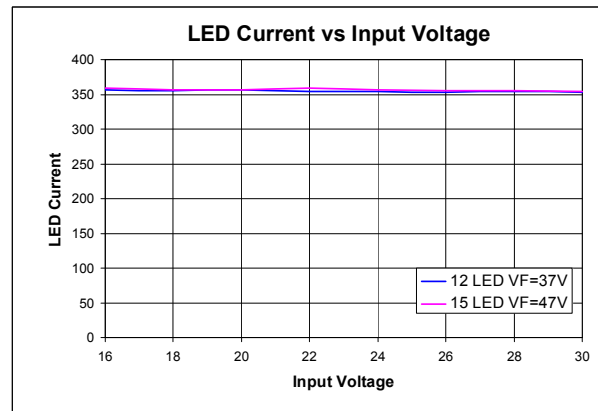

Figure 51 Line Regulation

Application Information (cont.)

350mA Buck-boost LED driver

In this application example, ZXLD1374 is connected as a Buck-boost LED driver with schematic and parts list shown below. The LED driver is able to deliver 350mA of LED current into 4/5 high brightness LED with input voltage ranged from 7V to 20V. In order to increase the driving voltage level for the internal MOSFET during low voltage input, bootstrap circuit formed by R6 D2 and C6 are used to supply higher voltage to the VAUX pin.

Since the Buck-boost LED driver can handle an input voltage range below and above the LED voltage, this versatile input voltage range makes it ideal for automotive lighting applications.

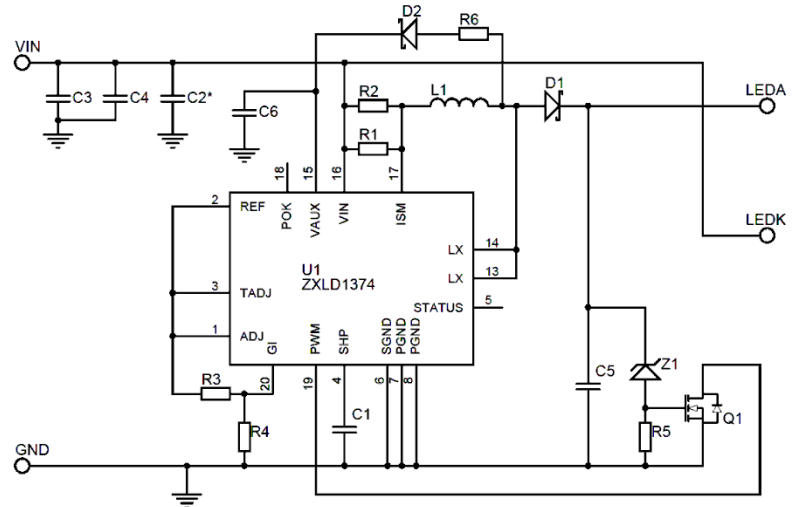

* Note: C2 is decoupling capacitor for U1. Connect closely to VIN and SGND pin.

Figure 52 Application Circuit of 350mA Buck-Boost LED Driver

Bill of Material

Ref No.	Value	Part No.	Manufacturer
U1	60V LED driver	ZXLD1374	Diodes Inc
Q1	60V MOSFET	2N7002A	Diodes Inc
D1	100V 3A Schottky	PDS3100-13	Diodes Inc
D2	100V 1A Schottky	B1100	Diodes Inc
Z1	47V 410mW Zener	BZT52C47	Diodes Inc
L1	47µH 2.6A	744771147	Würth Elektronik
C1	100pF 50V	SMD 0805/0603	Generic
C3 C4 C5	4.7µF 50V X7R	SMD1210	Generic
C2 C6	1µF 50V X7R	SMD1206	Generic
R1 R2	300mΩ 1%	SMD1206	Generic
R3	120kΩ 1%	SMD 0805/0603	Generic
R4	36kΩ 1%	SMD 0805/0603	Generic
R5	2.7kΩ	SMD 0805/0603	Generic
R6	1kΩ	SMD 1206	Generic

Typical Performance

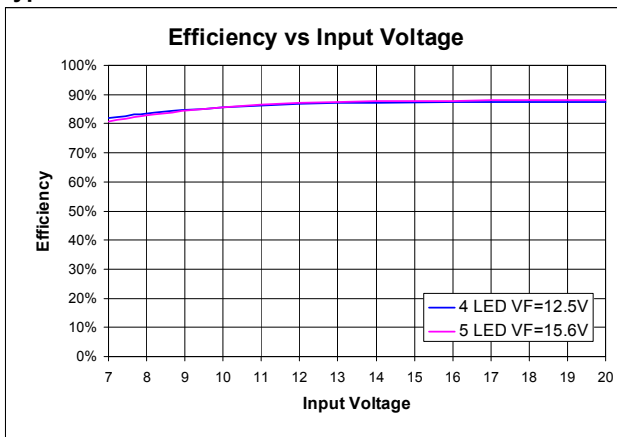

Figure 53 Efficiency

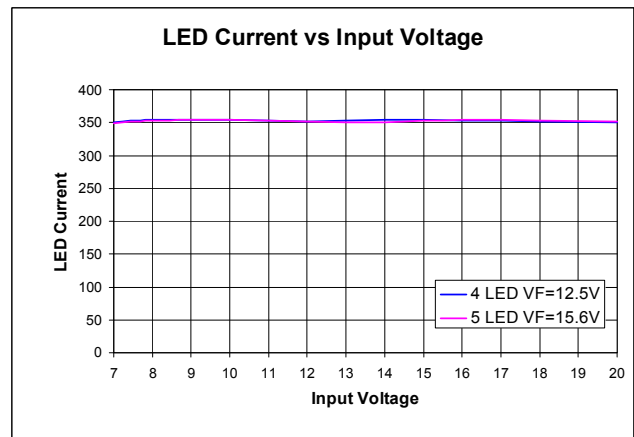

Figure 54 Line Regulation

Ordering Information

Part Number	Packaging	Part Marking	Reel Quantity	Tape Width	Reel Size	Qualification
ZXLD1374EST20TC	TSSOP-20EP	ZXLD 1374 YYWW	2500	16mm	13"	AEC-Q100 Grade 1
ZXLD1374QESTTC	TSSOP-20EP	ZXLD 1374 YYWW	2500	16mm	13"	Automotive Grade

Where YY stands for last 2 digits of year - 10, 11 and WW stands for week number

Package Outline Dimensions (All dimensions in mm.)

Please see AP02002 at <http://www.diodes.com/datasheets/ap02002.pdf> for latest version.

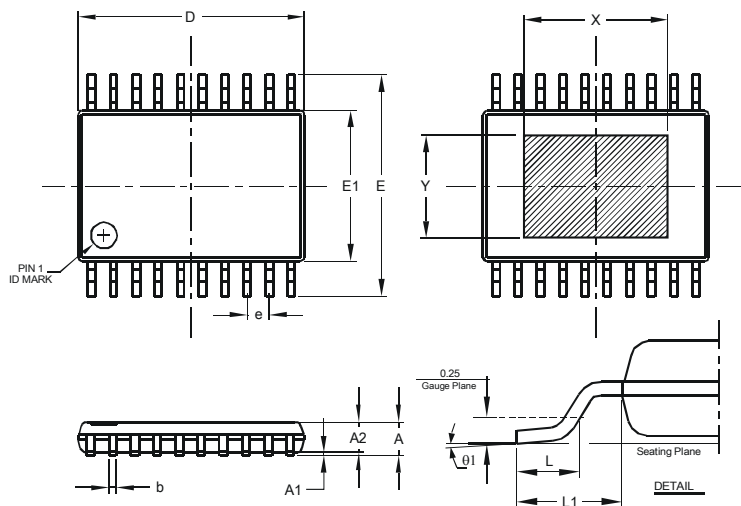

TSSOP-20EP			
Dim	Min	Max	Typ
A	-	1.20	-
A1	0.025	0.100	-
A2	0.80	1.05	0.90
b	0.19	0.30	-
c	0.09	0.20	-
D	6.40	6.60	6.50
E	6.20	6.60	6.40
E1	4.30	4.50	4.40
L	0.45	0.75	0.60
L1	1.0 REF		
L2	0.65 BSC		
X	-	-	4.191
Y	-	-	2.997
θ1	0°	8°	-

All Dimensions in mm

Suggested Pad Layout

Please see AP02001 at <http://www.diodes.com/datasheets/ap02001.pdf> for the latest version.

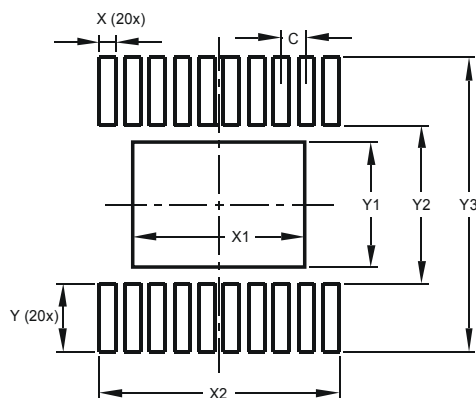

Dimensions	Value (in mm)
C	0.650
X	0.420
X1	4.490
X2	6.270
Y	1.780
Y1	3.290
Y2	4.160
Y3	7.720

IMPORTANT NOTICE

DIODES INCORPORATED MAKES NO WARRANTY OF ANY KIND, EXPRESS OR IMPLIED, WITH REGARDS TO THIS DOCUMENT, INCLUDING, BUT NOT LIMITED TO, THE IMPLIED WARRANTIES OF MERCHANTABILITY AND FITNESS FOR A PARTICULAR PURPOSE (AND THEIR EQUIVALENTS UNDER THE LAWS OF ANY JURISDICTION).

Diodes Incorporated and its subsidiaries reserve the right to make modifications, enhancements, improvements, corrections or other changes without further notice to this document and any product described herein. Diodes Incorporated does not assume any liability arising out of the application or use of this document or any product described herein; neither does Diodes Incorporated convey any license under its patent or trademark rights, nor the rights of others. Any Customer or user of this document or products described herein in such applications shall assume all risks of such use and will agree to hold Diodes Incorporated and all the companies whose products are represented on Diodes Incorporated website, harmless against all damages.

Diodes Incorporated does not warrant or accept any liability whatsoever in respect of any products purchased through unauthorized sales channel. Should Customers purchase or use Diodes Incorporated products for any unintended or unauthorized application, Customers shall indemnify and hold Diodes Incorporated and its representatives harmless against all claims, damages, expenses, and attorney fees arising out of, directly or indirectly, any claim of personal injury or death associated with such unintended or unauthorized application.

Products described herein may be covered by one or more United States, international or foreign patents pending. Product names and markings noted herein may also be covered by one or more United States, international or foreign trademarks.

LIFE SUPPORT

Diodes Incorporated products are specifically not authorized for use as critical components in life support devices or systems without the express written approval of the Chief Executive Officer of Diodes Incorporated. As used herein:

A. Life support devices or systems are devices or systems which:

1. are intended to implant into the body, or
2. support or sustain life and whose failure to perform when properly used in accordance with instructions for use provided in the labeling can be reasonably expected to result in significant injury to the user.

B. A critical component is any component in a life support device or system whose failure to perform can be reasonably expected to cause the failure of the life support device or to affect its safety or effectiveness.

Customers represent that they have all necessary expertise in the safety and regulatory ramifications of their life support devices or systems, and acknowledge and agree that they are solely responsible for all legal, regulatory and safety-related requirements concerning their products and any use of Diodes Incorporated products in such safety-critical, life support devices or systems, notwithstanding any devices- or systems-related information or support that may be provided by Diodes Incorporated. Further, Customers must fully indemnify Diodes Incorporated and its representatives against any damages arising out of the use of Diodes Incorporated products in such safety-critical, life support devices or systems.

Copyright © 2012, Diodes Incorporated

www.diodes.com