

Low-profile 6.4mm height contributes to flexibility in set design



### Typical Specifications

Items		Specifications
Rating (max.) (Resistive load)		10mA 5V DC
Contact resistance	8-direction	500mΩ max.
	Center-push	
Operating angle (8-direction)		Each direction 12° ± 3°
Travel (Center-push)		0.2 ± 0.1 mm
Operating life	Total with 8-direction	100,000 cycles
	Center-push	100,000 cycles

### Product Line

Product No.	Maximum resolution	Operating force		Minimum order unit (pcs.)	
		Direction (mN · m)	Center-push (N)	Japan	Export
<b>RKJXL100401V</b>	8-direction	10 ± 7	4.5 ± 1	800	1,600

### Packing Specifications

Tray

Number of packages (pcs.)		Export package measurements (mm)
1 case / Japan	1 case / export packing	
800	1,600	532 × 379 × 167

### Dimensions

Unit:mm

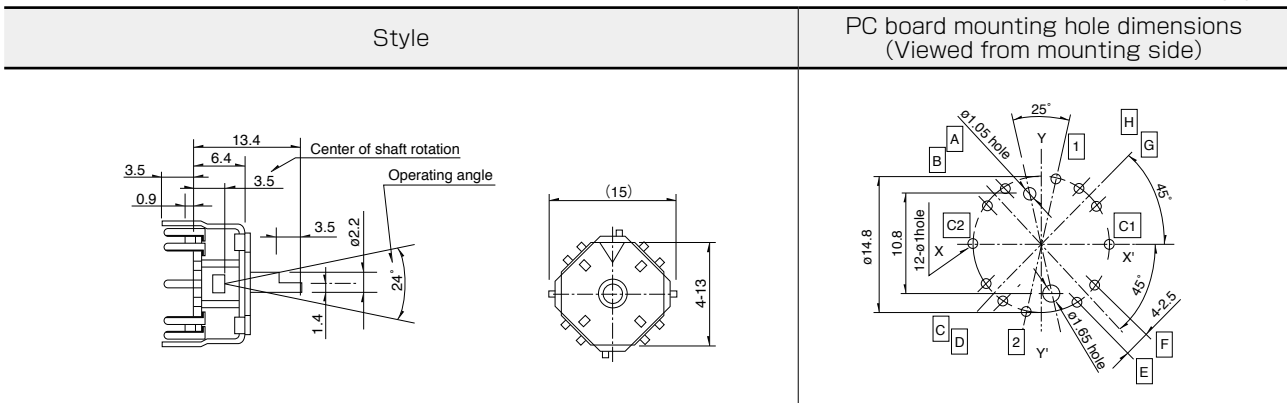

### Output Relation Chart Between Lever Position and ON Position.

Terminal The direction of the operation	A	B	C	D	E	F	G	H	C1	C2	1	2
A	ON								ON			
B		ON							ON			
C			ON						ON			
D				ON					ON			
E					ON					ON		
F						ON				ON		
G							ON			ON		
H								ON		ON		
Center Push											ON	ON

Operating direction of lever.





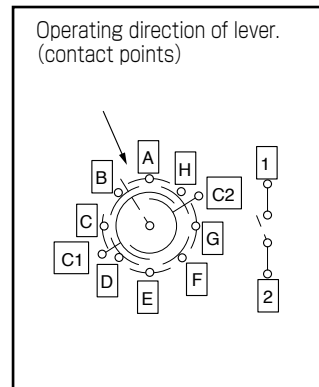

※ Shorting areas exist between adjacent terminals  
 ※ Between H and A, and D and E, both C1 and C2 are connected

### Circuit Diagram



# Multi Control Devices

## List of Varieties

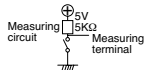
Type		Switch type			
Series		RKJXL	RKJXS	SKRH	
				SKRHAA/AB	SKRHAC/AD
Photo					
Dimensions (typical value) (mm)	W	13	11.7	7.35/7.45	
	D			7.5	
	H	6.4	2.3	5	
Number of operating shafts		Single-shaft			
Shaft material		Metal	Resin		
Directional resolution		8-direction		4-direction	
Directional operating feeling (tactile feeling)		Without		With	
Lever return mechanism		With			
Center-push switch		With			
Encoder		Without			
Operating temperature range		-30°C to +70°C	-20°C to +70°C	-40°C to +85°C	
Operating life	Directional operation	total with 8-direction 100,000 cycles	500,000 cycles for each direction	200,000 cycles for each direction	1,000,000 cycles for each direction
	Center-push	100,000 cycles	500,000 cycles	200,000 cycles	1,000,000 cycles
	Encoder	—	—	—	
Automotive use		●	—	—	
Life cycle (availability)					
Rating (max.) (Resistive load)		10mA 5V DC		50mA 12V DC	
Electrical performance	Output voltage	—	 1V max. at 1mA 5V DC (Resistive load)	—	
	Encoder resolution	—	—	—	
	Insulation resistance	100MΩ min. 250V DC	50MΩ min. 50V DC	100MΩ min. 100V DC	
	Voltage proof	300V AC for 1min. or 360V AC for 2s	50V AC for 1min. or 60V AC for 2s	100V AC for 1min.	
Mechanical performance	Directional operating force	10±7mN·m	0.8±0.5N	1.23±0.69N	1.2±0.69N
	Push operating force	4.5±1N	2.5±1.5N	2.35±0.69N	
	Encoder detent torque	—	—	—	
	Terminal strength	—	—	—	
	Actuator strength	Push / pull directions	100N (Push), 50N (Pull)	30N (Push), 10N (Pull)	—
Operating direction		100N	20N	29.4N	
Environmental performance	Cold	-40°C 500h	-40°C 96h		
	Dry heat	85°C 500h	85°C 96h	90°C 96h	
	Damp heat	60°C, 90 to 95%RH 500h	60°C, 90 to 95%RH 96h		
Page		442	443	444	

Switch Type Multi Control Devices Soldering Conditions . . . . . 451  
 Switch Type Multi Control Devices Cautions . . . . . 452

**Note**  
 ● Indicates applicability to all products in the series.

# Switch Type / Soldering Conditions

## Reference for Manual Soldering

Series	Tip temperature	Soldering time	No. of solders
<b>RKJXT1F, RKJXM, RKJXL, SLLB, SLLB5, SRBE, SKRH</b>	350±5℃	3s max.	1 time
<b>RKJXS</b>	350±10℃	3 <sup>+1</sup> <sub>-0</sub> s	2 time max.

## Reference for Dip Soldering

Series	Preheating		Dip soldering		No. of solders
	Soldering surface temperature	Heating time	Soldering temperature	Soldering time	
<b>RKJXT1F, RKJXM</b>	100℃ max.	2 min. max.	260±5℃	5±1s	2 time max.
<b>RKJXL</b>	120℃ max.	70s max.	260℃ max.	6s max.	2 time max.

## Example of Reflow Soldering Condition

1. Heating method: Double heating method with infrared heater.
2. Temperature measurement: Thermocouple  $\phi$ 0.1 to 0.2 CA (K) or CC (T) at soldering portion (copper foil surface).  
A heat resisting tape should be used for fixed measurement.
3. Temperature profile

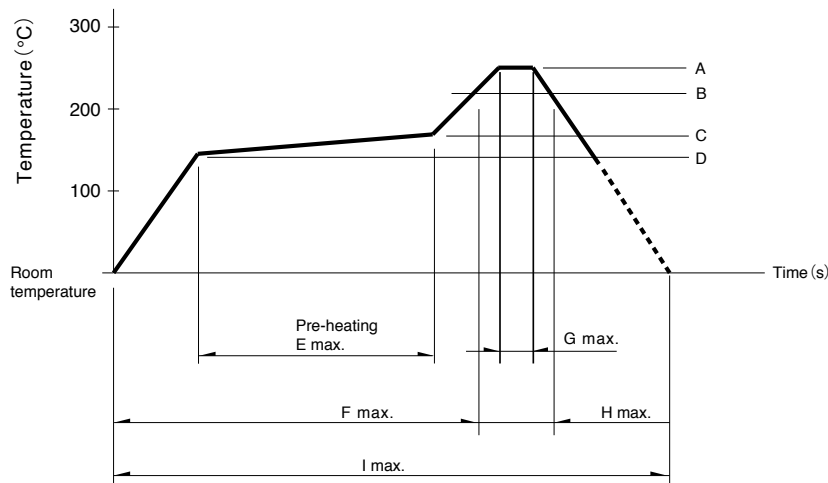

Series	A	B	C	D	E	F	G	H	I	No. of reflows
<b>RKJXS</b>	260℃	230℃	150℃	150℃	2 min.	—	10s	40s	4 min.	1 time
<b>SLLB5</b>	250℃	230℃	150℃	150℃	—	2 min.	—	30s	—	1 time
<b>SKRH, SLLB, SRBE</b>	260℃	230℃	180℃	150℃	2 min.	—	—	40s	—	1 time

### Notes

1. The above temperature shall be measured on the mounting surface of a PC board. There are cases where the PC board's temperature greatly differs from that of the switch, depending on the material, size thickness of PC boards and others. The above-stated conditions shall also apply to switch surface temperatures.
2. Soldering conditions differ depending on reflow soldering machines. Prior verification of soldering condition is highly recommended.