

1 Description

The RedRock™ RR121 Series is a magnetic sensor with digital push-pull output ideal for use in medical, industrial, automotive, and consumer applications. Based on patented Tunneling Magnetoresistance (TMR) technology with seamless CMOS integration, the RR121 offers multiple configurations of several parameters to enable applications like proximity sensing, rotary sensing, and level detection.

The RR121 features available operate sensitivities from 9 G (0.9 mT) to 70 G (7 mT), and either omnipolar, unipolar, or bipolar magnetic field response. It has the world's lowest average current drain (200 nA) for an active magnetic sensor, as well as operating frequencies up to 10 kHz and high operating temperature ranges from -40°C up to 125°C.

Device Information

Part Series	Package	Body Size (mm)
RR121	SOT-23-3	2.9 x 1.6 x 1.2
	LGA-4	1.4 x 1.4 x 0.45

Device Packages



2 Features

- ▶ Operate sensitivity from 9 G to 70 G
- ▶ Lowest Average Current < 200 nA
- ▶ Omnipolar and Bipolar Latching Responses Available
- ▶ Operating Frequencies up to 10 kHz
- ▶ Temperature Rated up to 125°C
- ▶ RoHS & REACH Compliant

3 Applications

- ▶ Proximity Detection
- ▶ Rotary Sensing
- ▶ Fluid Level Detection
- ▶ Door & Lid Closure Detection
- ▶ Utility Meters
- ▶ Portable Medical Devices
- ▶ Motor Controllers
- ▶ Consumer Electronics
- ▶ Wake-Up μ Processor

Functional Block Diagram

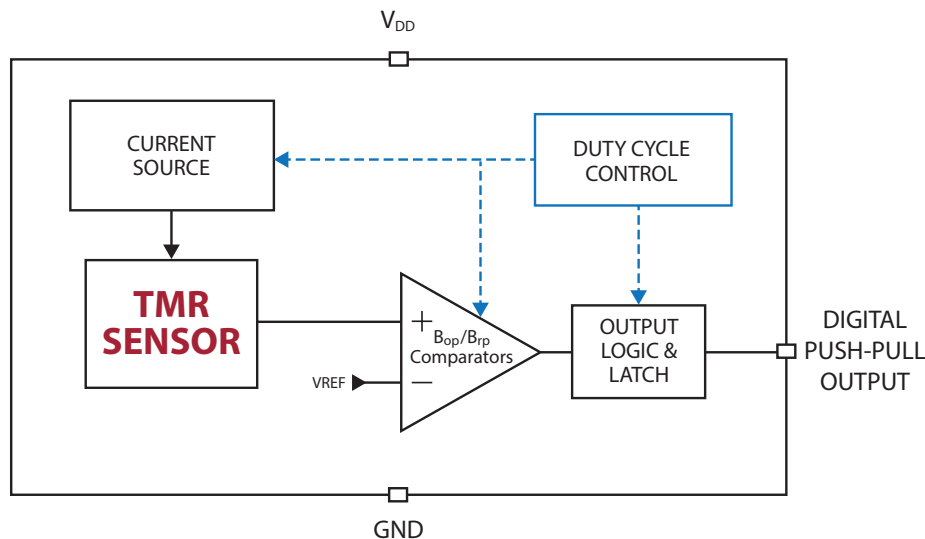

Table of Contents

1. Description.....	1	17.3 B _{OPN} (Orange) and B _{OPS} (Green) vs. Operating Temperature at V _{DD} =3.0 V	13
2. Features	1	17.4 B _{OPN} (Red) and B _{OPS} (Blue) vs. Supply Voltage at +25°C	13
3. Applications	1	18. Operate & Release Lobe Plots	13
4. Specifications for all RR121 Series Sensors	3	18.1 RR121-1B53-311	13
4.1 Absolute Environmental Ratings for all RR121 Series Sensors..	3	19. Operating Characteristics for RR121-3C63-311	14
4.2 Absolute Electrical Ratings for all RR121 Series Sensors	3	20. Graphs - Typical Characteristics for RR121-3C63-311	14
4.3 Operating Electrical Characteristics for all RR121 Series Sensors	3	20.1 Average Supply Current vs. Supply Voltage vs. Temperature	14
5. Operating Characteristics for RR121-1B13-311 and RR121-1B13-312	4	20.2 Average Supply Current vs. Temperature vs. Supply Voltage	14
6. Graphs - Typical Electrical Characteristics for RR121-1B13-311 and RR121-1B13-312	4	20.3 Sampling Frequency vs. Supply Voltage vs. Temperature ..	14
6.1 Average Supply Current vs. Supply Voltage vs. Temperature .	4	21. Operating Characteristics for RR121-1E73-311	15
6.2 Average Supply Current vs. Temperature vs. Supply Voltage .	4	22. Graphs - Typical Characteristics for RR121-1E73-311	15
6.3 Sampling Frequency vs. Supply Voltage vs. Temperature	5	22.1 Average Supply Current vs. Supply Voltage vs. Temperature	15
7. Graphs - Typical Magnetic Characteristics for RR121-1B13-311 and RR121-1B13-312	5	22.2 Average Supply Current vs. Temperature vs. Supply Voltage	15
7.1 B _{OPN} (Red) and B _{OPS} (Blue) vs. Supply Voltage at +25°C	5	22.3 Sampling Frequency vs. Supply Voltage vs. Temperature ..	16
7.2 B _{RPN} (Red) and B _{RPS} (Blue) vs. Supply Voltage at +25°C.....	5	23. Operating Characteristics for RR121-1B93-312	16
7.3 B _{OPN} (Orange) and B _{OPS} (Green) vs. Operating Temperature at V _{DD} =3.0 V	6	24. Graphs - Typical Characteristics for RR121-1B93-312	17
7.4 B _{OPN} (Red) and B _{OPS} (Blue) vs. Supply Voltage at +25°C	6	24.1 Sampling Frequency vs. Supply Voltage vs. Temperature ..	17
8. Operate & Release Lobe Plots	6	25. Graphs - Typical Magnetic Characteristics for RR121-1B93-311 ..	17
8.1 RR121-1B13-311	6	25.1 B _{OPN} (Red) and B _{OPS} (Blue) vs. Supply Voltage at +25°C	17
8.2 RR121-1B13-312	6	25.2 B _{RPN} (Red) and B _{RPS} (Blue) vs. Supply Voltage at +25°C	17
9. Operating Characteristics for RR121-1A23-311	7	25.3 B _{OPN} (Orange) and B _{OPS} (Green) vs. Operating Temperature at V _{DD} =3.0 V	18
10. Operating Characteristics for RR121-1F23-311	7	25.4 B _{OPN} (Red) and B _{OPS} (Blue) vs. Supply Voltage at +25°C	18
11. Graphs - Typical Characteristics for RR121-1A23-311 and RR121-1F23-311	8	26. Application Information	18
11.1 Average Supply Current vs. Supply Voltage vs. Temperature	8	26.1 RR121 Push-Pull Output Application Circuit (SOT-23)	18
11.2 Average Supply Current vs. Temperature vs. Supply Voltage	8	26.2 RR121 Push-Pull Output Application Circuit (LGA-4)	18
11.3 Sampling Frequency vs. Supply Voltage vs. Temperature ...	8	27. Part Selection & Ordering Information	19
12. Graphs - Typical Magnetic Characteristics for RR121-1A23-311 ...	9	27.1 Part Selection Table	19
12.1 B _{OPN} (Red) and B _{OPS} (Blue) vs. Supply Voltage at +25°C	9	27.2 Device Nomenclature Ordering Information	19
12.2 B _{RPN} (Red) and B _{RPS} (Blue) vs. Supply Voltage at +25°C	9	28. Axis of Sensitivity	19
12.3 B _{OPN} (Orange) and B _{OPS} (Green) vs. Operating Temperature at V _{DD} =3.0 V	9	29. Dimensions	20
12.4 B _{OPN} (Red) and B _{OPS} (Blue) vs. Supply Voltage at +25°C	9	29.1 LGA-4 Package Dimensions	20
13. Operate & Release Lobe Plot	10	29.2 SOT-23-3 Package Dimensions	20
11.1 RR121-1A23-311	10	30. TMR Sensor Location	20
14. Operating Characteristics for RR121-1B53-311	10	30.1 LGA Package	20
15. Operating Characteristics for RR121-1A53-311	11	30.2 SOT Package	20
16. Graphs - Typical Characteristics for RR121-1B53-311 and RR121-1A53-311	11	31. Magnetic Flux Response Diagrams	21
16.1 Average Supply Current vs. Supply Voltage vs. Temperature	11	31.1 Omnipolar Magnetic Flux Response (Active Low Option) ..	21
16.2 Average Supply Current vs. Temperature vs. Supply Voltage	11	31.2 Bipolar Magnetic Flux Response (Active Low Option)	21
16.3 Sampling Frequency vs. Supply Voltage vs. Temperature ..	12	32. Output Behavior vs. Magnetic Field Diagrams	21
17. Graphs - Typical Magnetic Characteristics for RR121-1B53-311 ..	12	32.1 Output Behavior vs. Magnetic Field - Omnipolar	21
17.1 B _{OPN} (Red) and B _{OPS} (Blue) vs. Supply Voltage at +25°C	12	32.2 Output Behavior vs. Magnetic Field - Bipolar	21
17.2 B _{RPN} (Red) and B _{RPS} (Blue) vs. Supply Voltage at +25°C	12	33. TMR Sensor & Switch Packaging	22
17.3 B _{OPN} (Orange) and B _{OPS} (Green) vs. Operating Temperature at V _{DD} =3.0 V	13	33.1 SOT-23-3 Tape & Reel Packaging	22
17.4 B _{OPN} (Red) and B _{OPS} (Blue) vs. Supply Voltage at +25°C	13	33.2 LGA-4 Tape & Reel Packaging	23
18. Operate & Release Lobe Plots	13	34. Suggested Pb-Free Reflow Profile	24
18.1 RR121-1B53-311	13	35. Suggested Solder Pad Layout	24
19. Operating Characteristics for RR121-3C63-311	14	35.1 SOT-23-3 Solder Pad Layout	24
20. Graphs - Typical Characteristics for RR121-3C63-311	14	35.2 LGA-4 Solder Pad Layout	24
20.1 Average Supply Current vs. Supply Voltage vs. Temperature	14		
20.2 Average Supply Current vs. Temperature vs. Supply Voltage	14		
20.3 Sampling Frequency vs. Supply Voltage vs. Temperature ..	14		
21. Operating Characteristics for RR121-1E73-311	15		
22. Graphs - Typical Characteristics for RR121-1E73-311	15		
22.1 Average Supply Current vs. Supply Voltage vs. Temperature	15		
22.2 Average Supply Current vs. Temperature vs. Supply Voltage	15		
22.3 Sampling Frequency vs. Supply Voltage vs. Temperature ..	16		
23. Operating Characteristics for RR121-1B93-312	16		
24. Graphs - Typical Characteristics for RR121-1B93-312	17		
24.1 Sampling Frequency vs. Supply Voltage vs. Temperature ..	17		
25. Graphs - Typical Magnetic Characteristics for RR121-1B93-311 ..	17		
25.1 B _{OPN} (Red) and B _{OPS} (Blue) vs. Supply Voltage at +25°C	17		
25.2 B _{RPN} (Red) and B _{RPS} (Blue) vs. Supply Voltage at +25°C	17		
25.3 B _{OPN} (Orange) and B _{OPS} (Green) vs. Operating Temperature at V _{DD} =3.0 V	18		
25.4 B _{OPN} (Red) and B _{OPS} (Blue) vs. Supply Voltage at +25°C	18		
26. Application Information	18		
26.1 RR121 Push-Pull Output Application Circuit (SOT-23)	18		
26.2 RR121 Push-Pull Output Application Circuit (LGA-4)	18		
27. Part Selection & Ordering Information	19		
27.1 Part Selection Table	19		
27.2 Device Nomenclature Ordering Information	19		
28. Axis of Sensitivity	19		
29. Dimensions	20		
29.1 LGA-4 Package Dimensions	20		
29.2 SOT-23-3 Package Dimensions	20		
30. TMR Sensor Location	20		
30.1 LGA Package	20		
30.2 SOT Package	20		
31. Magnetic Flux Response Diagrams	21		
31.1 Omnipolar Magnetic Flux Response (Active Low Option) ..	21		
31.2 Bipolar Magnetic Flux Response (Active Low Option)	21		
32. Output Behavior vs. Magnetic Field Diagrams	21		
32.1 Output Behavior vs. Magnetic Field - Omnipolar	21		
32.2 Output Behavior vs. Magnetic Field - Bipolar	21		
33. TMR Sensor & Switch Packaging	22		
33.1 SOT-23-3 Tape & Reel Packaging	22		
33.2 LGA-4 Tape & Reel Packaging	23		
34. Suggested Pb-Free Reflow Profile	24		
35. Suggested Solder Pad Layout	24		
35.1 SOT-23-3 Solder Pad Layout	24		
35.2 LGA-4 Solder Pad Layout	24		

4 Specifications for all RR121 Series Sensors

4.1 Absolute Environmental Ratings for all RR121 Series Sensors¹

Parameters	Units	Min	Typ	Max
Operating Temperature (T_{OP})	°C	-40		+125
Storage Temperature (T_{STG})	°C	-65		+150
Junction Temperature (T_J)	°C	-40		+150
Soldering Temperature (3 cycles, 1 min.) (T_{SOL})	°C			+260
ESD Level Human Body Model per JESD22-A114	V			±4000

4.2 Absolute Electrical Ratings for all RR121 Series Sensors¹

Parameters	Units	Min	Typ	Max
Supply Voltage (V_{DD})	V	-0.3		+4.0
Push-pull Output (Active Low)(V_{OUT_PP})	V	-0.3		$V_{DD} + 0.3$
Open Drain Output Voltage (Active Low) (V_{OUT_OD})	V	-0.3		+5.5
Input and Output Current (V_{IN}/I_{OUT})	mA	-10		+10

4.3 Operating Electrical Characteristics for all RR121 Series Sensors²

Parameters	Units	Min	Typ	Max
Supply Voltage (V_{DD})	V	+2.7	+3.0	+3.6
Output Voltage (High) ³ (V_{OUTH})	V	90% V_{DD}		
Output Voltage (Low) ³ (V_{OUTL})	V			10% V_{DD}
Power-On Time (t_{ON})($V_{DD} > 2.7V$)	μs		500	
Under-Voltage Lockout Threshold Rising V_{DD} (V_{UVLO_RISE})	V		+2.20	+2.60
Under-Voltage Lockout Threshold Falling V_{DD} (V_{UVLO_FALL})	V	+1.90	+2.15	
Under-Voltage Lockout Hysteresis (V_{UV_HYST})	mV		+50	

Notes:

- Exceeding Absolute Ratings may cause permanent damage to the device. Exposure at the maximum rated conditions for extended periods of time may also affect device reliability.
- Unless otherwise specified, all characteristics are measured at 25°C.
- See "Magnetic Field vs. Output Status" for more details.



ESD Note: This product uses semiconductors that can be damaged by electrostatic discharge (ESD). When handling, proper ESD precautions should be taken to avoid performance degradation or loss of functionality. Damage due to inappropriate handling is not covered under warranty.

5 Operating Characteristics for RR121-1B13-311 and RR121-1B13-312¹

Parameters	Units	Min	Typ	Max
Average Supply Current ($I_{DD(AVG)}$) ²	nA		200	700
Switching Frequency (f_{SW})	Hz	1	2	4
Active Mode Time (t_{ACT})	μ s		1.4	
Idle Mode Time (t_{IDLE})	ms		500	
Operate Point (B_{OPN})	G	27	30	38
Operate Point (B_{OPS})	G	-38	-30	-27
Release Point (B_{RPN})	G	18	20	27
Release Point (B_{RPS})	G	-27	-20	-18
Hysteresis (B_{HYST}) ³	G	5	10	

Notes:

1. Unless otherwise specified, $V_{DD} = 2.7\text{ V to }3.6\text{ V}$, $T_A = -40^\circ\text{C to }+125^\circ\text{C}$. Typical values are $V_{DD} = 3.0\text{ V}$ and $T_A = +25^\circ\text{C}$.
2. Conditions: $t = 10\text{ seconds}$
3. Conditions: $B_{HYST} = B_{OP} - B_{RP}$

6 Graphs - Typical Electrical Characteristics for RR121-1B13-311 and RR121-1B13-312

$V_{DD} = 3.0\text{ V}$ and $T_A = +25^\circ\text{C}$, $C_{DD} = 1.0\ \mu\text{F}$ (unless otherwise specified)

6.1 Average Supply Current vs. Supply Voltage vs. Temperature

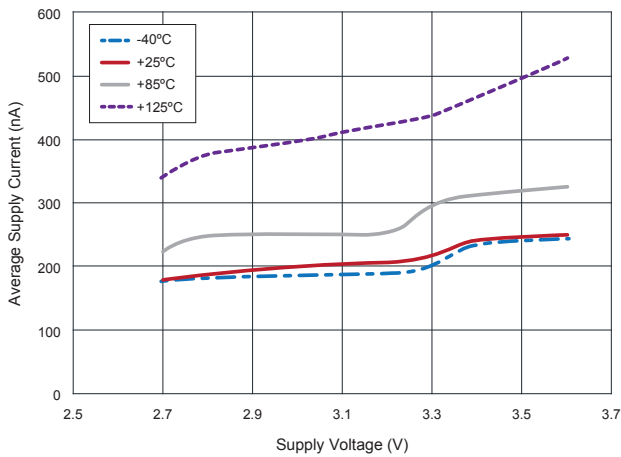

6.2 Average Supply Current vs. Temperature vs. Supply Voltage

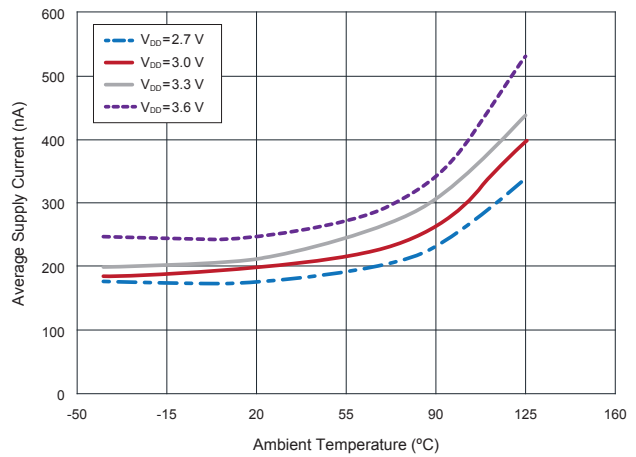

6 Graphs - Typical Electrical Characteristics for RR121-1B13-311 and RR121-1B13-312

$V_{DD} = 3.0\text{ V}$ and $T_A = +25\text{ }^\circ\text{C}$, $C_{DD} = 1.0\text{ }\mu\text{F}$ (unless otherwise specified)

6.3 Sampling Frequency vs. Supply Voltage vs. Temperature

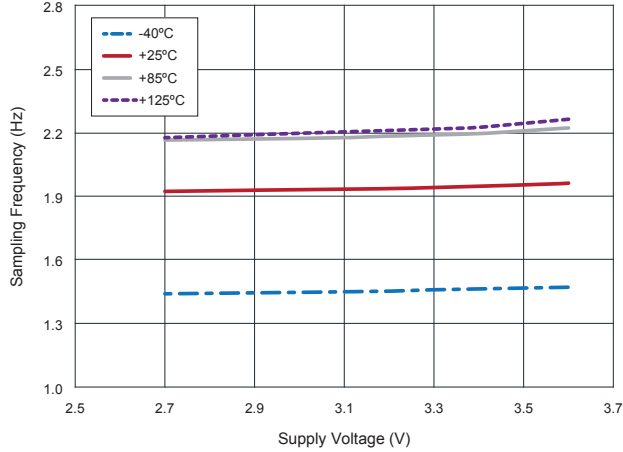

7 Graphs - Typical Magnetic Characteristics for RR121-1B13-311 and RR121-1B13-312

$V_{DD} = 3.0\text{ V}$ and $T_A = +25\text{ }^\circ\text{C}$, $C_{DD} = 1.0\text{ }\mu\text{F}$ (unless otherwise specified)

7.1 B_{OPN} (Blue) and B_{OPS} (Red) vs. Supply Voltage at +25°C

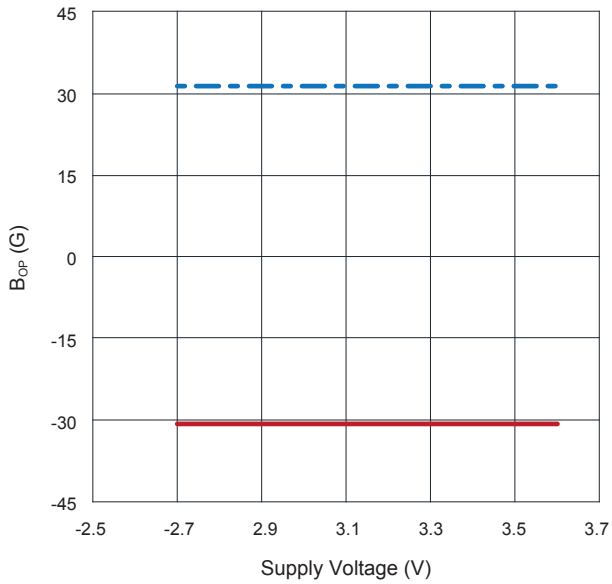

7.2 B_{RPN} (Blue) and B_{RPS} (Red) vs. Supply Voltage at +25°C

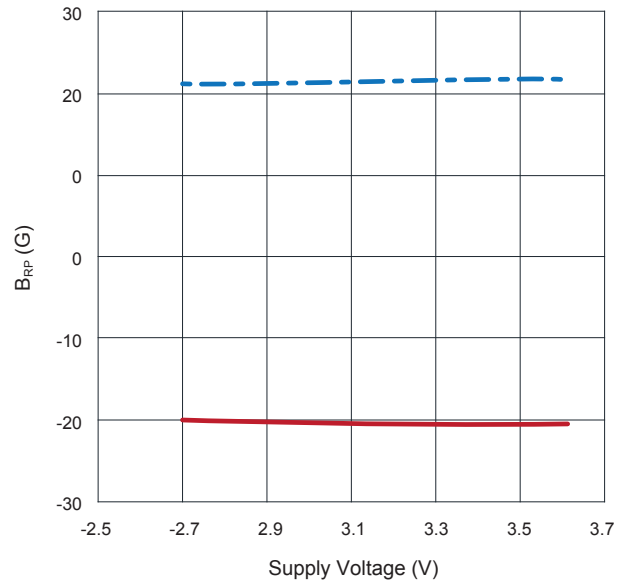

7 Graphs - Typical Magnetic Characteristics for RR121-1B13-311 and RR121-1B13-312

$V_{DD} = 3.0\text{ V}$ and $T_A = +25\text{ }^\circ\text{C}$, $C_{DD} = 1.0\text{ }\mu\text{F}$ (unless otherwise specified)

7.3 B_{OPN} (Blue) and B_{OPS} (Red) vs. Operating Temperature at $V_{DD}=3.0\text{ V}$

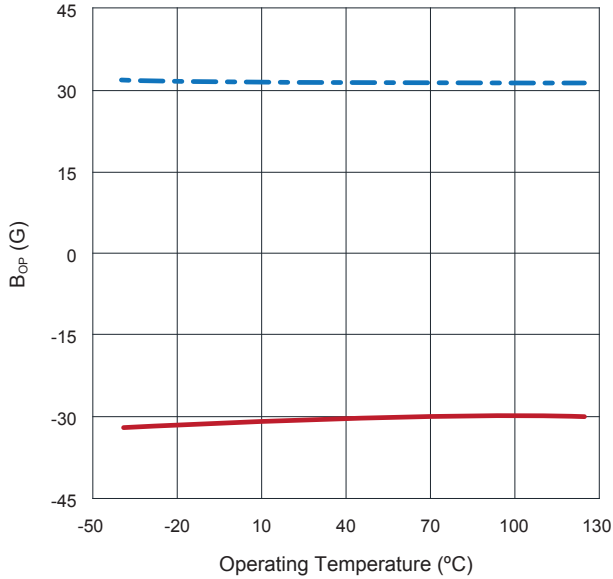

7.4 B_{RPN} (Blue) and B_{RPS} (Red) vs. Operating Temperature at $V_{DD}=3.0\text{ V}$

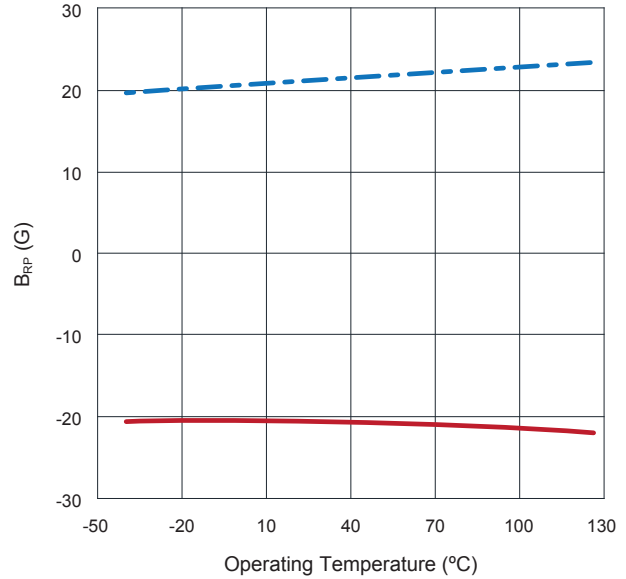

8 Operate & Release Lobe Plots

Operate and release distances show are relative. The actual operate and release distances will depend on the type of magnet that is used.

8.1 RR121-1B13-311

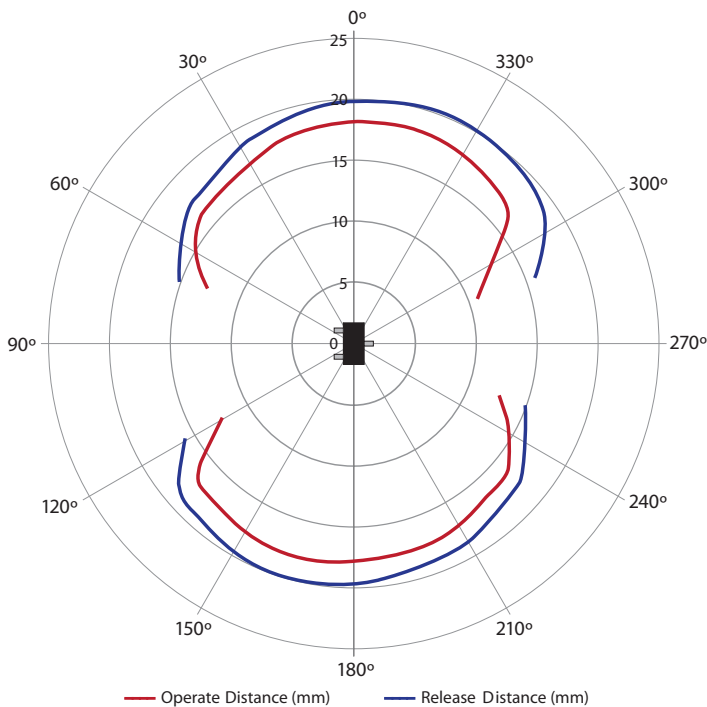

8.2 RR121-1B13-312

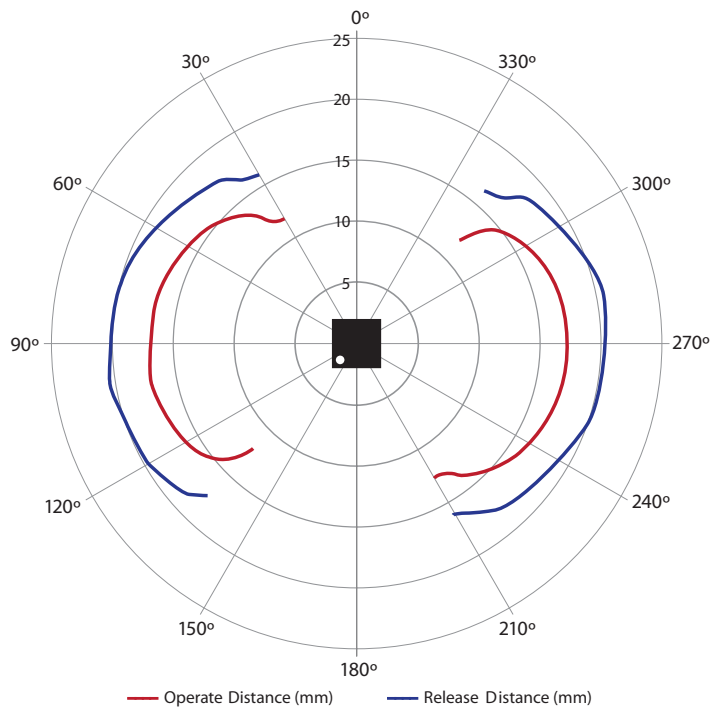

9 Operating Characteristics for RR121-1A23-311¹

Parameters	Units	Min	Typ	Max
Average Supply Current ($I_{DD(AVG)}$) ²	nA		230	700
Switching Frequency (f_{SW})	Hz	7	10	13
Active Mode Time (t_{ACT})	μs		1.4	
Idle Mode Time (t_{IDLE})	ms		100	
Operate Point (B_{OPN})	G	8	9	12
Operate Point (B_{OPS})	G	-12	-9	-8
Release Point (B_{RPN})	G	3	5	7
Release Point (B_{RPS})	G	-7	-5	-3
Hysteresis (B_{HYST}) ³	G	3	4	

Notes:

1. Unless otherwise specified, $V_{DD} = 2.7\text{ V to }3.6\text{ V}$, $T_A = -40^\circ\text{C to }+125^\circ\text{C}$. Typical values are $V_{DD} = 3.0\text{ V}$ and $T_A = +25^\circ\text{C}$.
2. Conditions: $t = 10\text{ seconds}$
3. Conditions: $B_{HYST} = B_{OP} - B_{RP}$

10 Operating Characteristics for RR121-1F23-311¹

Parameters	Units	Min	Typ	Max
Average Supply Current ($I_{DD(AVG)}$) ²	nA		230	700
Switching Frequency (f_{SW})	Hz	7	10	13
Active Mode Time (t_{ACT})	μs		1.4	
Idle Mode Time (t_{IDLE})	ms	77	100	143
Operate Point (B_{OPN})	G		70	
Operate Point (B_{OPS})	G		-70	
Release Point (B_{RPN})	G		50	
Release Point (B_{RPS})	G		-50	
Hysteresis (B_{HYST}) ³	G		20	

Notes:

1. Unless otherwise specified, $V_{DD} = 2.7\text{ V to }3.6\text{ V}$, $T_A = -40^\circ\text{C to }+125^\circ\text{C}$. Typical values are $V_{DD} = 3.0\text{ V}$ and $T_A = +25^\circ\text{C}$.
2. Conditions: $t = 10\text{ seconds}$
3. Conditions: $B_{HYST} = B_{OP} - B_{RP}$

11 Graphs - Typical Characteristics for RR121-1A23-311 and RR121-1F23-311

$V_{DD} = 3.0\text{ V}$ and $T_A = +25\text{ }^\circ\text{C}$, $C_{DD} = 1.0\text{ }\mu\text{F}$ (unless otherwise specified)

11.1 Average Supply Current vs. Supply Voltage vs. Temperature

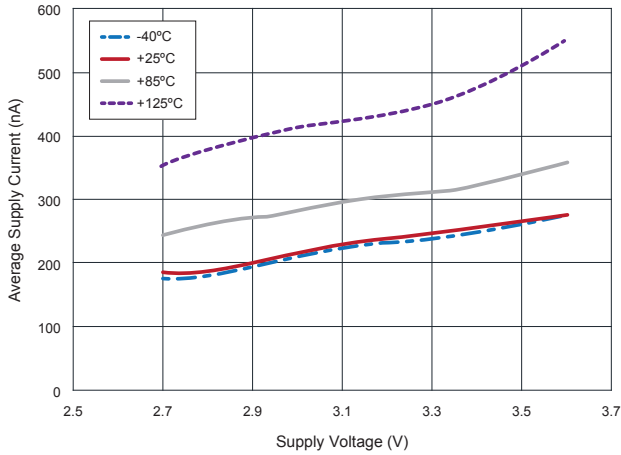

11.2 Average Supply Current vs. Temperature vs. Supply Voltage

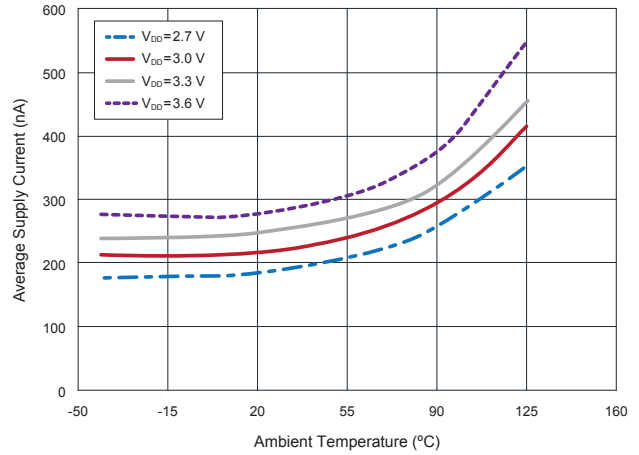

11.3 Sampling Frequency vs. Supply Voltage vs. Temperature

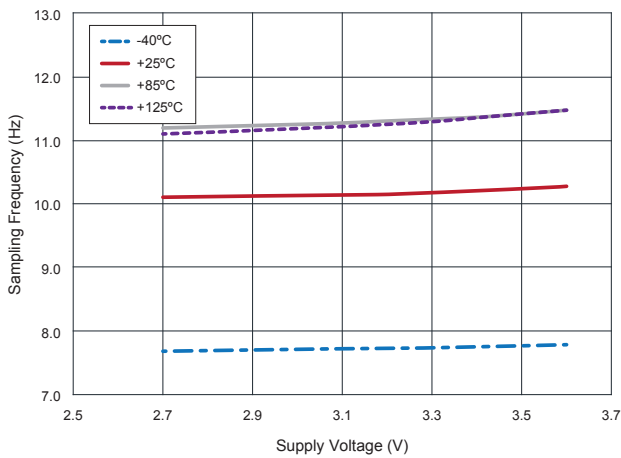

12 Graphs - Typical Magnetic Characteristics for RR121-1A23-311
 $V_{DD} = 3.0\text{ V}$ and $T_A = +25\text{ }^\circ\text{C}$, $C_{DD} = 1.0\text{ }\mu\text{F}$ (unless otherwise specified)

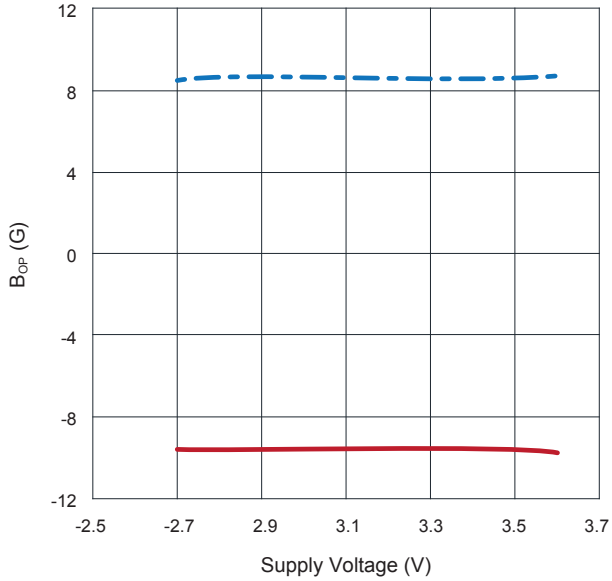
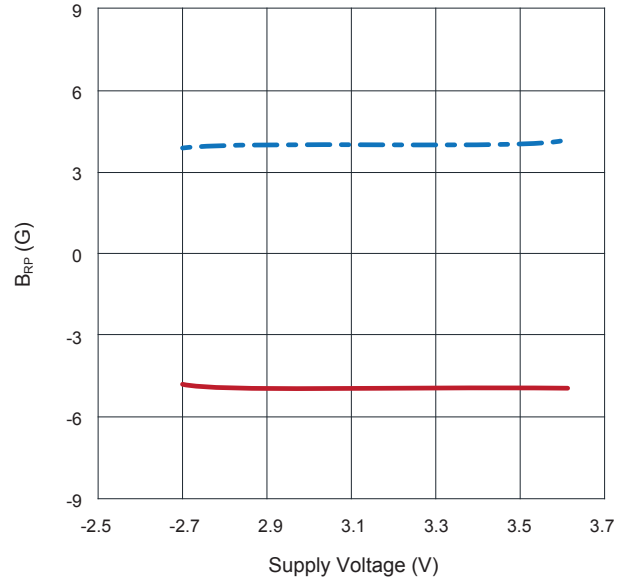
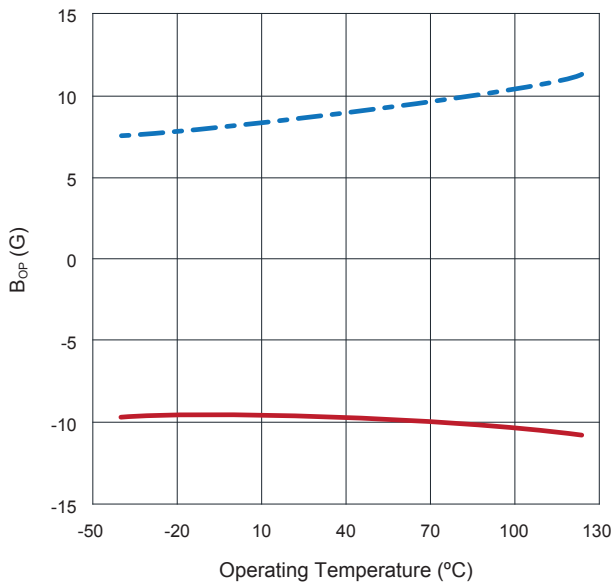
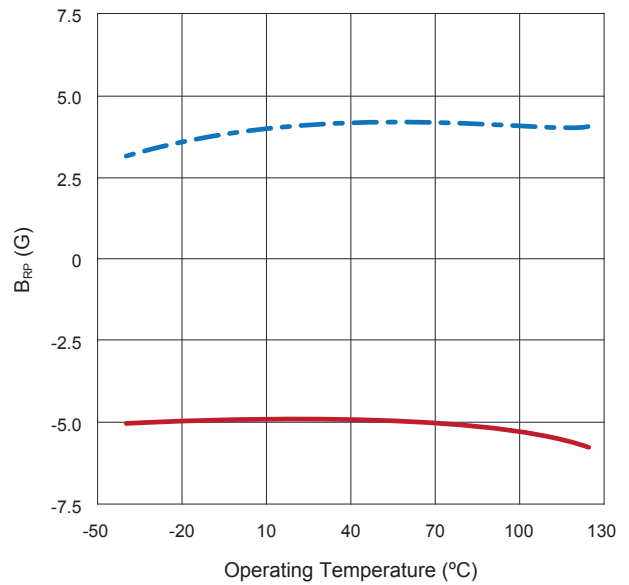
12.1 B_{OPN} (Blue) and B_{OPS} (Red) vs. Supply Voltage at $+25^\circ\text{C}$

12.2 B_{RPN} (Blue) and B_{RPS} (Red) vs. Supply Voltage at $+25^\circ\text{C}$

12.3 B_{OPN} (Blue) and B_{OPS} (Red) vs. Operating Temperature at $V_{DD}=3.0\text{ V}$

12.4 B_{RPN} (Blue) and B_{RPS} (Red) vs. Operating Temperature at $V_{DD}=3.0\text{ V}$

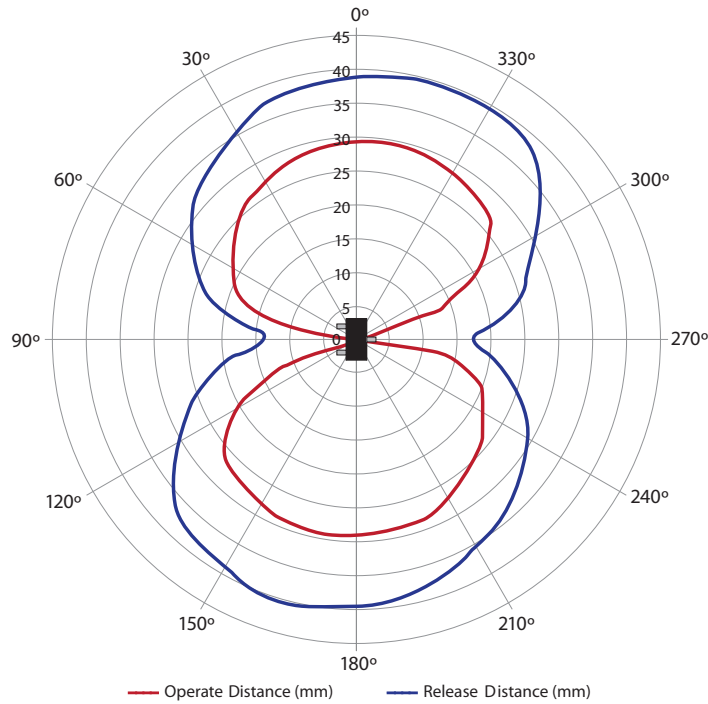
13 Operate & Release Lobe Plot

Operate and release distances show are relative. The actual operate and release distances will depend on the type of magnet that is used.

13.1 RR121-1A23-311



14 Operating Characteristics for RR121-1B53-311¹

Parameters	Units	Min	Typ	Max
Average Supply Current ($I_{DD(AVG)}$) ²	μA		1.4	2.5
Switching Frequency (f_{SW})	Hz	165	250	300
Active Mode Time (t_{ACT})	μs		1.4	
Idle Mode Time (t_{IDLE})	ms		4.0	
Operate Point (B_{OPN})	G	27	30	38
Operate Point (B_{OPS})	G	-38	-30	-27
Release Point (B_{RPN})	G	18	20	27
Release Point (B_{RPS})	G	-27	-20	-18
Hysteresis (B_{HYST}) ³	G	5	10	

Notes:

1. Unless otherwise specified, $V_{DD} = 2.7 V$ to $3.6 V$, $T_A = -40^\circ C$ to $+125^\circ C$. Typical values are $V_{DD} = 3.0 V$ and $T_A = +25^\circ C$.
2. Conditions: $t = 10$ seconds
3. Conditions: $B_{HYST} = B_{OP} - B_{RP}$

15 Operating Characteristics for RR121-1A53-311¹

Parameters	Units	Min	Typ	Max
Average Supply Current ($I_{DD(AVG)}$) ²	μA		1.2	2.5
Switching Frequency (f_{SW})	Hz	165	250	300
Active Mode Time (t_{ACT})	μs		1.4	
Idle Mode Time (t_{IDLE})	ms	3.3	4.0	6.0
Operate Point (B_{OPN})	G	8	9	12
Operate Point (B_{OPS})	G	-12	-9	-8
Release Point (B_{RPN})	G	3	5	7
Release Point (B_{RPS})	G	-7	-5	-3
Hysteresis (B_{HYST}) ³	G	3	4	

Notes:

- Unless otherwise specified, $V_{DD} = 2.7\text{ V to }3.6\text{ V}$, $T_A = -40^\circ\text{C to }+125^\circ\text{C}$. Typical values are $V_{DD} = 3.0\text{ V}$ and $T_A = +25^\circ\text{C}$.
- Conditions: $t = 10\text{ seconds}$
- Conditions: $B_{HYST} = B_{OP} - B_{RP}$

16 Graphs - Typical Characteristics for RR121-1B53-311 and RR121-1A53-311

$V_{DD} = 3.0\text{ V}$ and $T_A = +25^\circ\text{C}$, $C_{DD} = 1.0\text{ }\mu\text{F}$ (unless otherwise specified)

16.1 Average Supply Current vs. Supply Voltage vs. Temperature

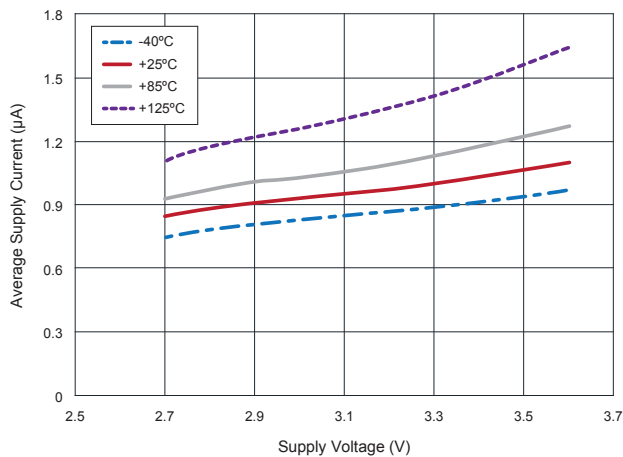

16.2 Average Supply Current vs. Temperature vs. Supply Voltage

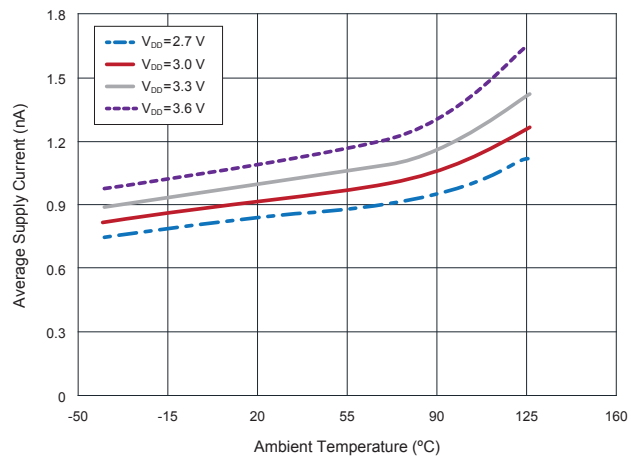

16 Typical Characteristics for RR121-1B53-311 and RR121-1A53-311

$V_{DD} = 3.0\text{ V}$ and $T_A = +25\text{ }^\circ\text{C}$, $C_{DD} = 1.0\text{ }\mu\text{F}$ (unless otherwise specified)

16.3 Sampling Frequency vs. Supply Voltage vs. Temperature

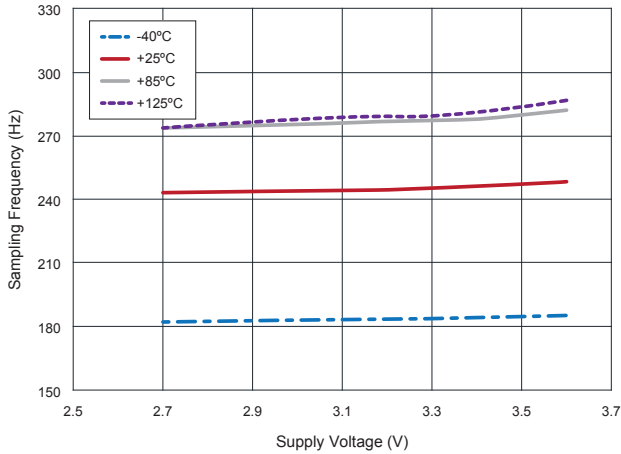

17 Graphs - Typical Magnetic Characteristics for RR121-1B53-311

$V_{DD} = 3.0\text{ V}$ and $T_A = +25\text{ }^\circ\text{C}$, $C_{DD} = 1.0\text{ }\mu\text{F}$ (unless otherwise specified)

17.1 B_{OPN} (Blue) and B_{OP5} (Red) vs. Supply Voltage at +25°C

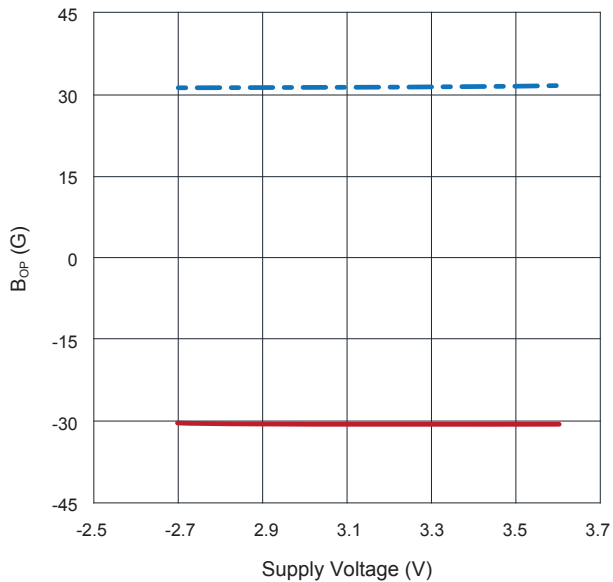

17.2 B_{RPN} (Blue) and B_{RPS} (Red) vs. Supply Voltage at +25°C

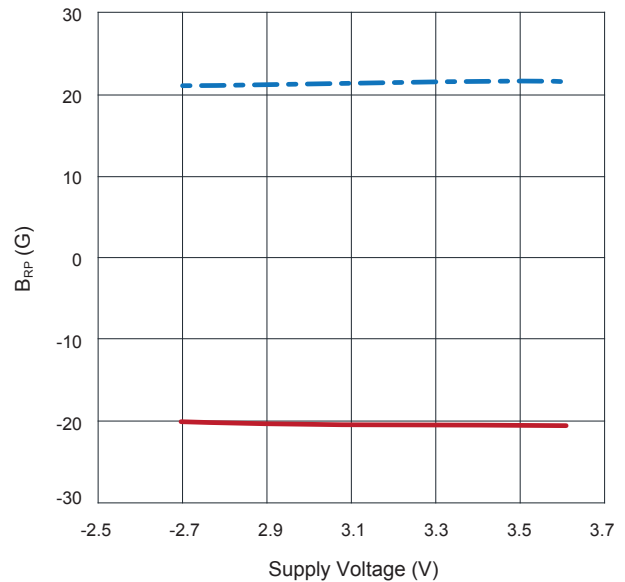

17 Graphs - Typical Magnetic Characteristics for RR121-1B53-311

$V_{DD} = 3.0\text{ V}$ and $T_A = +25\text{ }^\circ\text{C}$, $C_{DD} = 1.0\text{ }\mu\text{F}$ (unless otherwise specified)

17.3 B_{OPN} (Blue) and B_{OPS} (Red) vs. Operating Temperature at $V_{DD}=3.0\text{ V}$

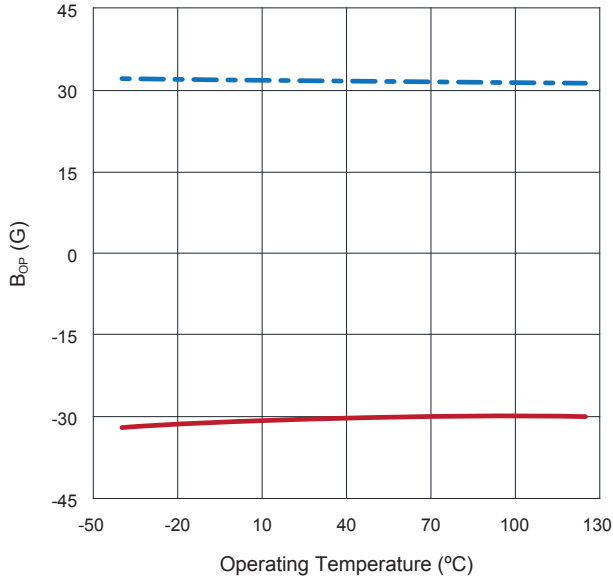

17.4 B_{RPN} (Blue) and B_{RPS} (Red) vs. Operating Temperature at $V_{DD}=3.0\text{ V}$

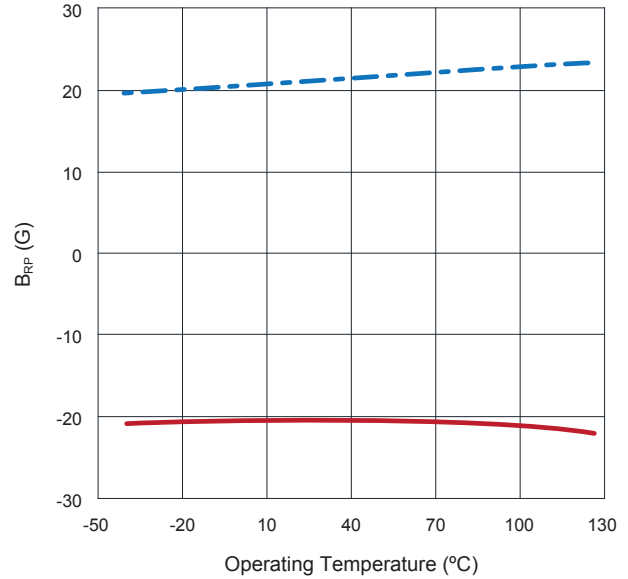

18 Operate & Release Lobe Plot

Operate and release distances show are relative. The actual operate and release distances will depend on the type of magnet that is used.

18.1 RR121-1B53-311

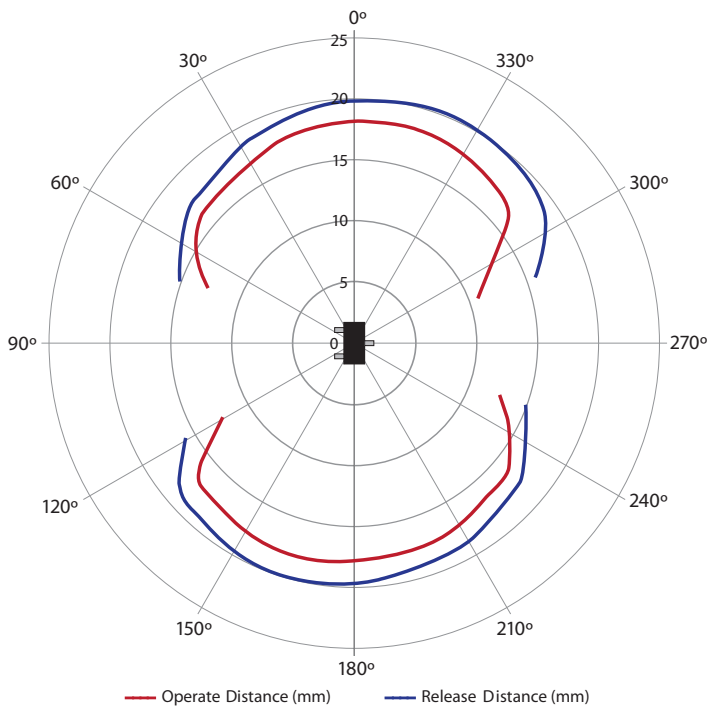

19 Operating Characteristics for RR121-3C63-311¹

Parameters	Units	Min	Typ	Max
Average Supply Current ($I_{DD(AVG)}$) ²	μA		1.7	3.3
Switching Frequency (f_{SW})	Hz	325	500	600
Active Mode Time (t_{ACT})	μs		1.4	
Idle Mode Time (t_{IDLE})	ms		2.0	
Operate Point (B_{OPS})	G	8	10	14
Release Point (B_{RPN})	G	14	-10	-8

Notes:

1. Unless otherwise specified, $V_{DD} = 2.7 V$ to $3.6 V$, $T_A = -40^\circ C$ to $+125^\circ C$. Typical values are $V_{DD} = 3.0 V$ and $T_A = +25^\circ C$.
2. Conditions: $t=10$

20 Graphs - Typical Characteristics for RR121-3C63-311

$V_{DD} = 3.0 V$ and $T_A = +25^\circ C$, $C_{DD} = 1.0 \mu F$ (unless otherwise specified)

20.1 Average Supply Current vs. Supply Voltage vs. Temperature

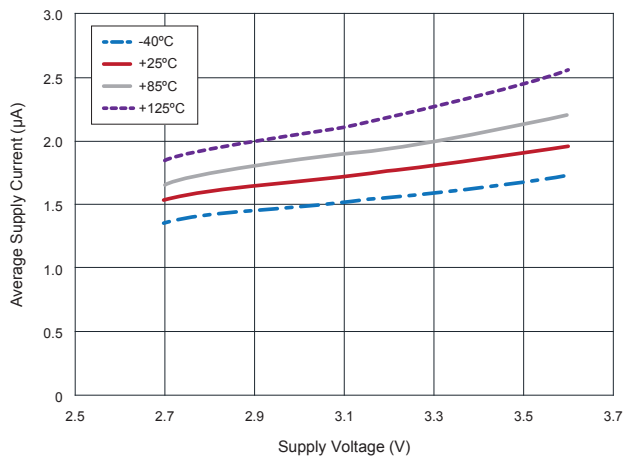

20.2 Average Supply Current vs. Temperature vs. Supply Voltage

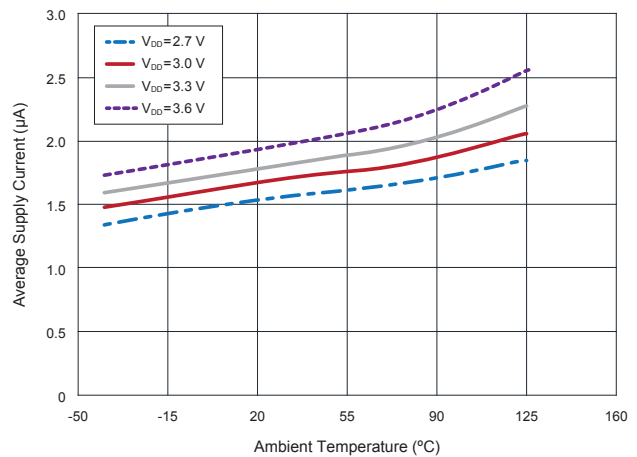

20.3 Sampling Frequency vs. Supply Voltage vs. Temperature

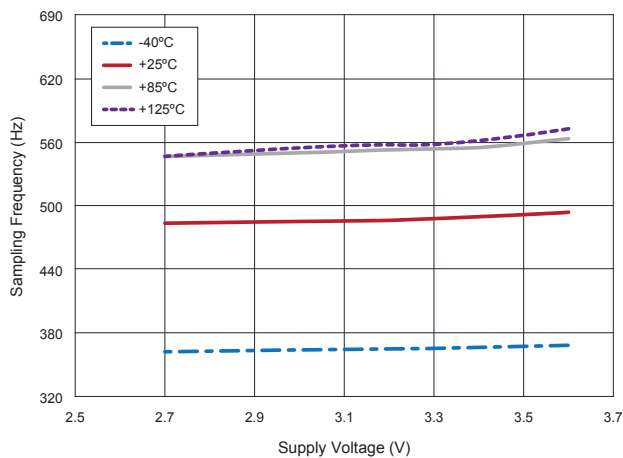

21 Operating Characteristics for RR121-1E73-311¹

Parameters	Units	Min	Typ	Max
Average Supply Current ($I_{DD(AVG)}$) ²	μA		8	13
Switching Frequency (f_{SW})	Hz	1.63	2.50	3.25
Active Mode Time (t_{ACT})	μs		1.4	
Idle Mode Time (t_{IDLE})	ms	308	400	614
Operate Point (B_{OPN})	G	13	15	18
Operate Point (B_{OPS})	G	-18	-15	-13
Release Point (B_{RPN})	G	8	10	13
Release Point (B_{RPS})	G	-13	-10	-8
Hysteresis (B_{HYST}) ³	G	3	5	

Notes:

- Unless otherwise specified, $V_{DD} = 2.7\text{ V}$ to 3.6 V , $T_A = -40^\circ\text{C}$ to $+125^\circ\text{C}$. Typical values are $V_{DD} = 3.0\text{ V}$ and $T_A = +25^\circ\text{C}$.
- Conditions: $t = 10$ seconds
- Conditions: $B_{HYST} = B_{OP} - B_{RP}$

22 Graphs - Typical Characteristics for RR121-1E73-311

$V_{DD} = 3.0\text{ V}$ and $T_A = +25^\circ\text{C}$, $C_{DD} = 1.0\ \mu\text{F}$ (unless otherwise specified)

22.1 Average Supply Current vs. Supply Voltage vs. Temperature

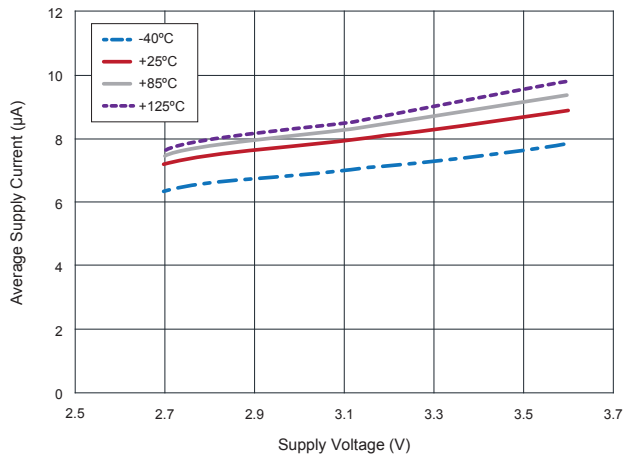

22.2 Average Supply Current vs. Temperature vs. Supply Voltage

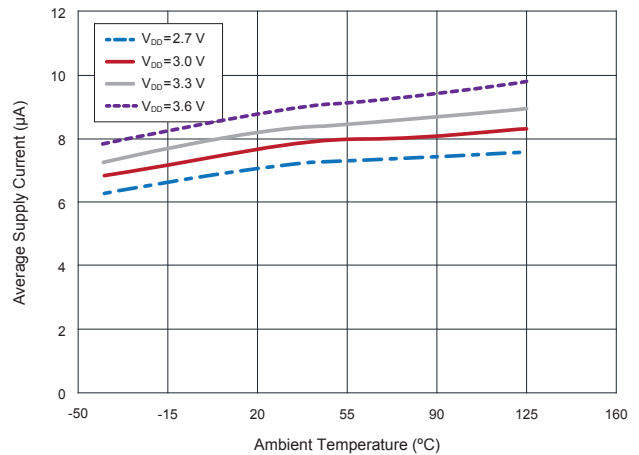

22 Typical Characteristics for RR121-1E73-311

$V_{DD} = 3.0\text{ V}$ and $T_A = +25\text{ }^\circ\text{C}$, $C_{DD} = 1.0\text{ }\mu\text{F}$ (unless otherwise specified)

22.3 Sampling Frequency vs. Supply Voltage vs. Temperature

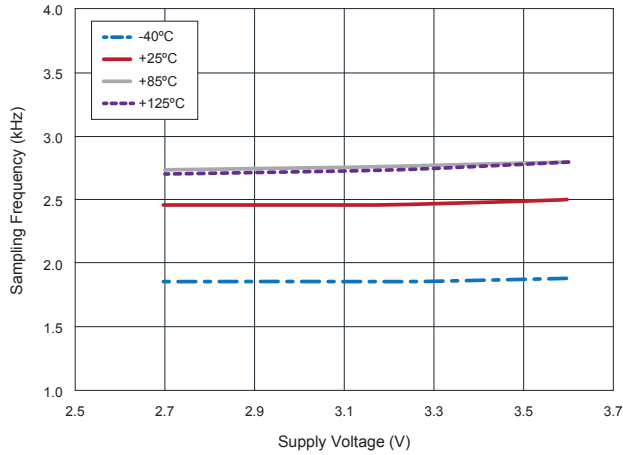

23 Operating Characteristics for RR121-1B93-312¹

Parameters	Units	Min	Typ	Max
Average Supply Current ($I_{DD(AVG)}$) ²	μA		36	
Switching Frequency (f_{SW})	kHz	7	10	13
Active Mode Time (t_{ACT})	μs		1.4	
Idle Mode Time (t_{IDLE})	ms	77	100	143
Operate Point (B_{OPN})	G	27	30	38
Operate Point (B_{OPS})	G	-38	-30	-27
Release Point (B_{RPN})	G	18	20	27
Release Point (B_{RPS})	G	-27	-20	-18
Hysteresis (B_{HYST}) ³	G	5	10	

Notes:

1. Unless otherwise specified, $V_{DD} = 2.7\text{ V}$ to 3.6 V , $T_A = -40^\circ\text{C}$ to $+125^\circ\text{C}$. Typical values are $V_{DD} = 3.0\text{ V}$ and $T_A = +25^\circ\text{C}$.
2. Conditions: $t = 10\text{ seconds}$
3. Conditions: $B_{HYST} = B_{OP} - B_{RP}$

24 Graphs - Typical Characteristics for RR121-1B93-312

$V_{DD} = 3.0\text{ V}$ and $T_A = +25\text{ }^\circ\text{C}$, $C_{DD} = 1.0\text{ }\mu\text{F}$ (unless otherwise specified)

24.1 Sampling Frequency vs. Supply Voltage vs. Temperature

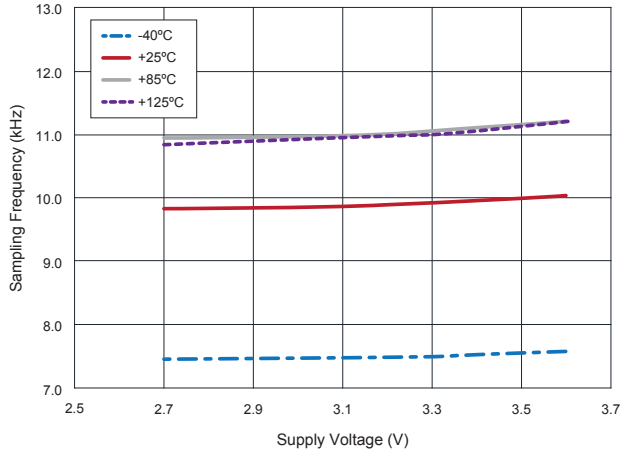

25 Graphs - Typical Magnetic Characteristics for RR121-1B93-312

$V_{DD} = 3.0\text{ V}$ and $T_A = +25\text{ }^\circ\text{C}$, $C_{DD} = 1.0\text{ }\mu\text{F}$ (unless otherwise specified)

25.1 B_{OPN} (Blue) and B_{OPS} (Red) vs. Supply Voltage at +25°C

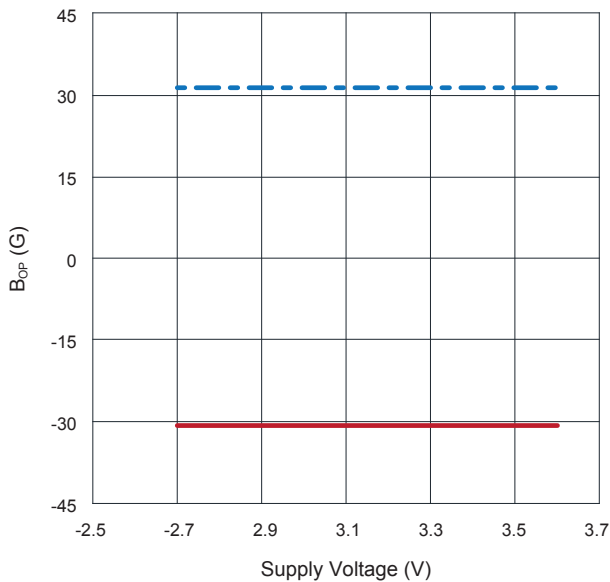

25.2 B_{RPN} (Blue) and B_{RPS} (Red) vs. Supply Voltage at +25°C

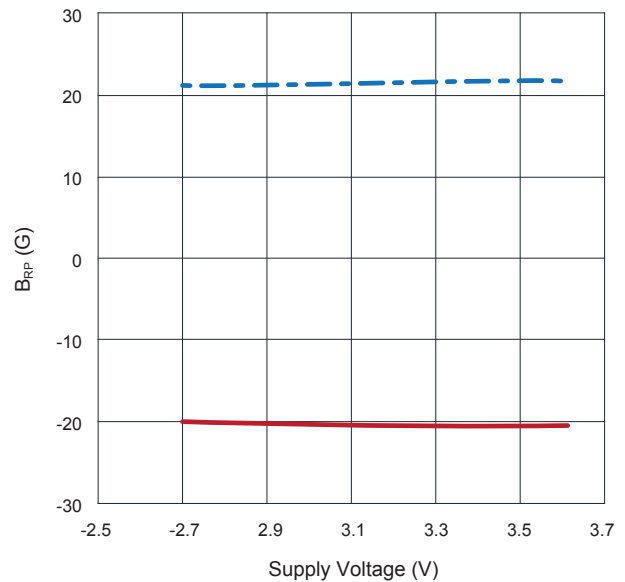

25 Typical Magnetic Characteristics for RR121-1B93-312

$V_{DD} = 3.0\text{ V}$ and $T_A = +25\text{ }^\circ\text{C}$, $C_{DD} = 1.0\text{ }\mu\text{F}$ (unless otherwise specified)

25.3 B_{OPN} (Blue) and B_{OPS} (Red) vs. Operating Temperature at $V_{DD}=3.0\text{ V}$

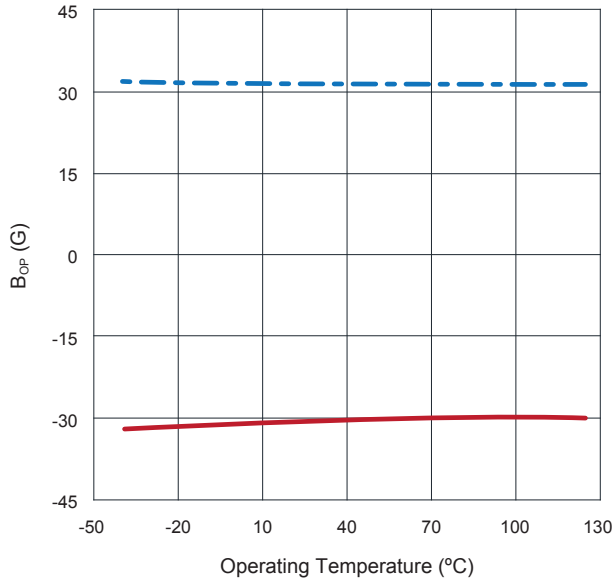

25.4 B_{RPN} (Blue) and B_{RPS} (Red) vs. Operating Temperature at $V_{DD}=3.0\text{ V}$

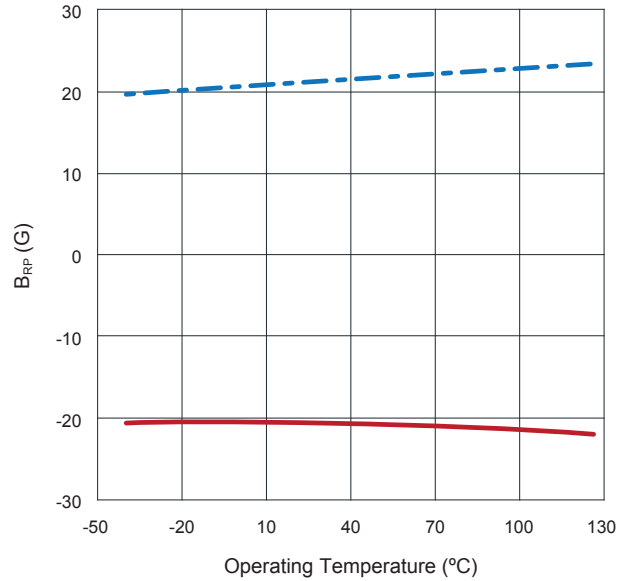

26 Application Information

26.1 Application Circuit (SOT-23)

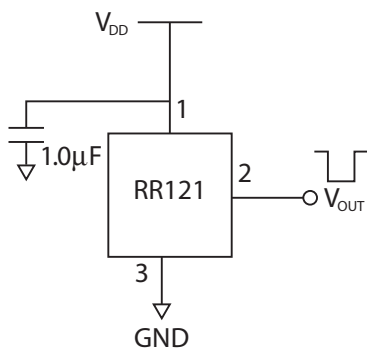

26.2 Application Circuit (LGA-4)

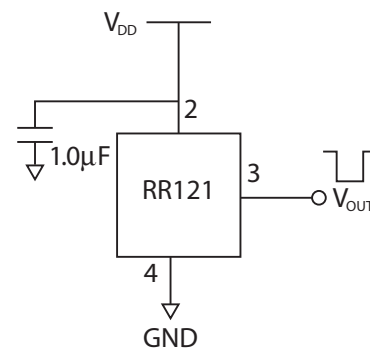

RR121 Push-Pull Output Application Circuit

The output voltage on the RR121 is active low, meaning that while a sufficiently strong magnetic field is present, the output voltage is low. The output voltage can be connected to a digital I/O pin on a microcontroller. A decoupling capacitor between the supply voltage and ground is required with placement close to the magnetic sensor. A typical capacitor value of $1.0\text{ }\mu\text{F}$ will suffice.

27 Part Selection and Ordering Information

27.1 Part Selection Table

Part Number	Magnetic Polarity Response	Operate Sensitivity (G)	Release Sensitivity (G)	Frequency (Hz)	I _{avg} (μA)	Temp. Rating (°C)	Supply Voltage (V _{dd})	Output Response	Package
RR121-1B13-312	Omnipolar	30	20	2	0.20	-40 - +125	2.7 - 3.6	Active Low	LGA-4
RR121-1B13-311	Omnipolar	30	20	2	0.20	-40 - +125	2.7 - 3.6	Active Low	SOT-23-3
RR121-1B53-311	Omnipolar	30	20	250	1.44	-40 - +125	2.7 - 3.6	Active Low	SOT-23-3
RR121-1A23-311	Omnipolar	9	5	10	0.24	-40 - +125	2.7 - 3.6	Active Low	SOT-23-3
RR121-3C63-311	Bipolar	10	-10	500	1.70	-40 - +125	2.7 - 3.6	Active Low	SOT-23-3
RR121-1F23-311	Omnipolar	70	50	10	0.24	-40 - +125	2.7 - 3.6	Active Low	SOT-23-3
RR121-1A53-311	Omnipolar	9	5	250	1.44	-40 - +125	2.7 - 3.6	Active Low	SOT-23-3
RR121-1E73-311	Omnipolar	15	10	2500	8	-40 - +125	2.7 - 3.6	Active Low	SOT-23-3
RR121-1B93-312	Omnipolar	30	20	10000	36	-40 - +125	2.7 - 3.6	Active Low	LGA-4

Note:

- Custom options available for Sensitivity, Frequency, Temperature Rating, Supply Voltage, Output Response & more. Please contact redrock@cotorelay.com for more details.

27.2 Device Nomenclature

Ordering Information

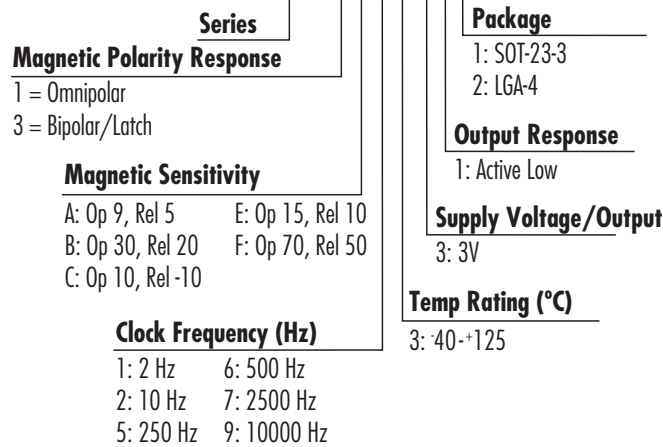
RR121-X X X 3-YYY

28 Axis of Sensitivity

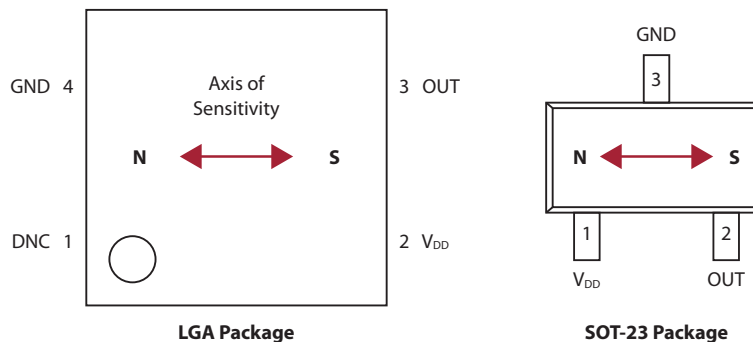

29 Dimensions *Millimeters (Inches)*

29.1 LGA-4 Package

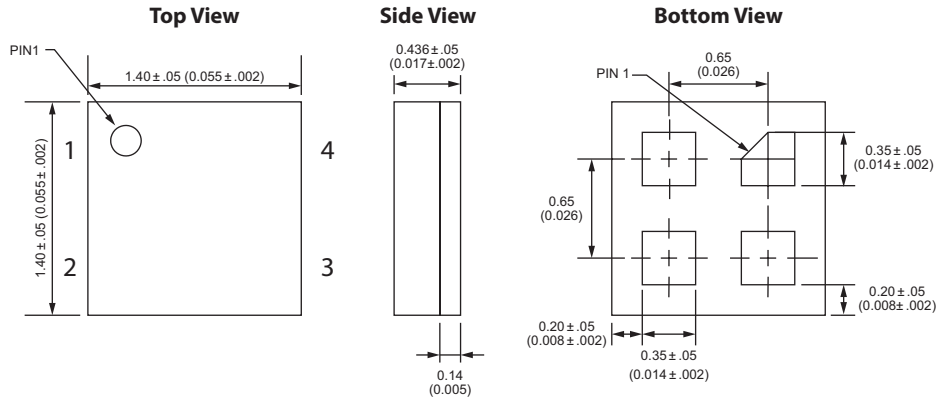

29.2 SOT-23-3 Package

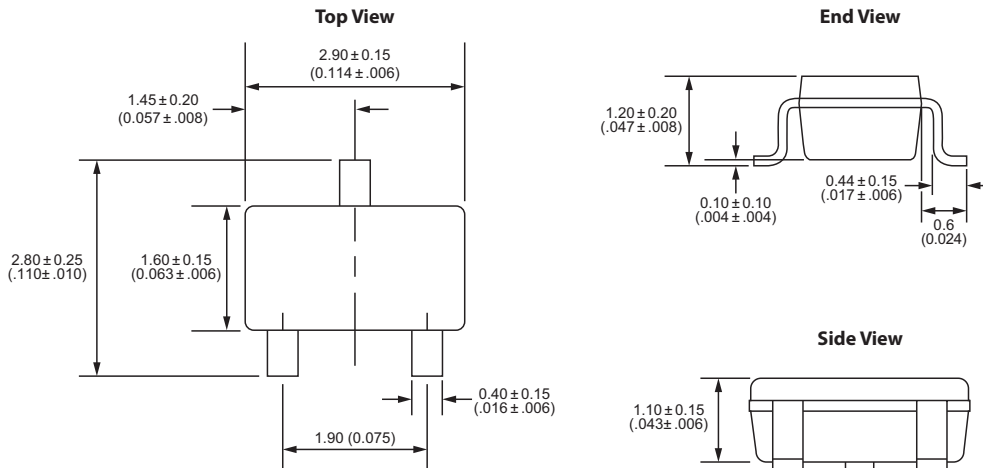

30 TMR Sensor Location

30.1 LGA Package

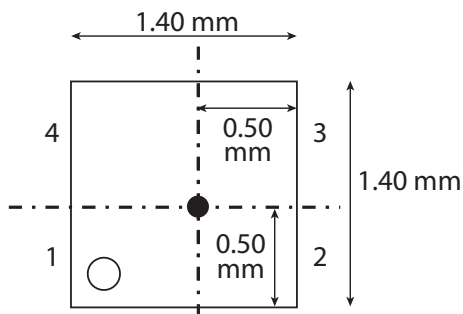

30.2 SOT Package

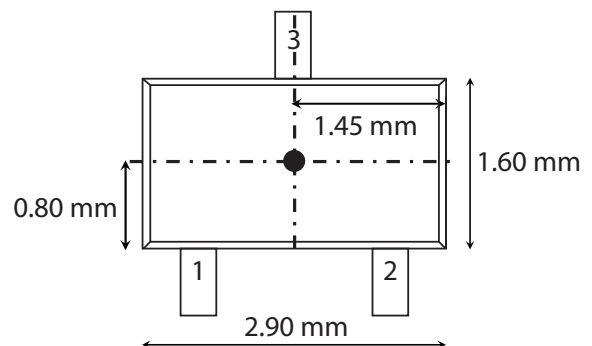

31 Magnetic Flux Response Diagrams

31.1 Omnipolar Magnetic Flux Response (Active Low Option)

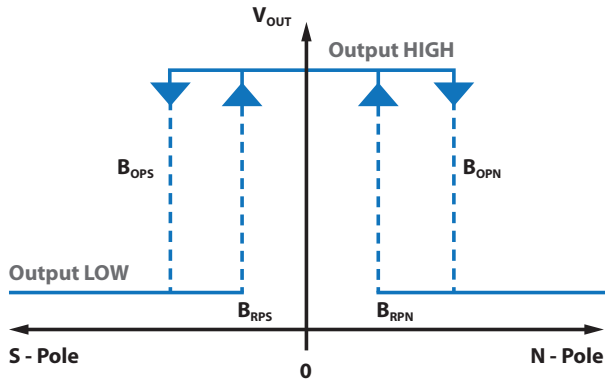

31.2 Bipolar Magnetic Flux Response (Active Low Option)

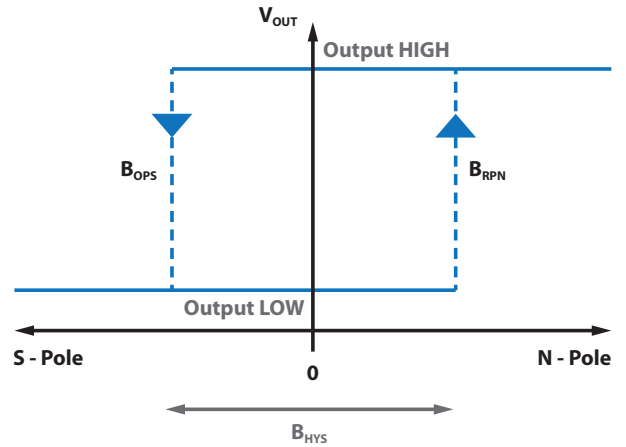

32 Output Behavior vs. Magnetic Field Diagrams

32.1 Output Behavior vs. Magnetic Field - Omnipolar

Characteristics	Conditions	Output
South Pole	$B < B_{OPS}$ $0 > B > B_{RPS}$	Low (ON) High (OFF)
North Pole	$B > B_{OPN}$ $0 < B < B_{RPN}$	Low (ON) High (OFF)

32.2 Output Behavior vs. Magnetic Field - Bipolar

Characteristics	Conditions	Output
South Pole	$B < B_{OPS}$	Low (ON)
North Pole	$B > B_{RPN}$	High (OFF)

34 Suggested Pb-Free Reflow Profile

- Notes:**
1. Fully compatible with standard no-lead solder profile, 260 °C for 30 seconds max (3 cycles max).
 2. Profile shown as example. Users are advised to develop their own board-level profile.
 3. Suggested Pb-free reflow profile derived from IPC/JEDEC J-STD-020E.
 4. Temperature tolerance: +0 °C, as measured at any point on the package or leads
 5. MSL rating of 1 (SOT-23-3 only) compatible with J-STD-020 or equivalent.
 6. MSL rating of 3 (LGA-4 only) compatible with J-STD-020 or equivalent.
 7. All temperatures refer to the center of the package, measured on the package body surface that is facing up during assembly reflow (e.g., live-bug). If parts are reflowed in other than the normal live bug assembly reflow orientation (i.e., dead-bug), T_p shall be within ± 2 °C of the live bug T_p and still meet the T_c requirements, otherwise, the profile shall be adjusted to achieve the latter. To accurately measure actual peak package body temperatures, refer to JEP140 for recommended thermocouple use.
 8. Reflow profiles in this document are for classification/preconditioning and are not meant to specify board assembly profiles. Actual board assembly profiles should be developed based on specific process needs and board designs and should not exceed the parameters in this table.

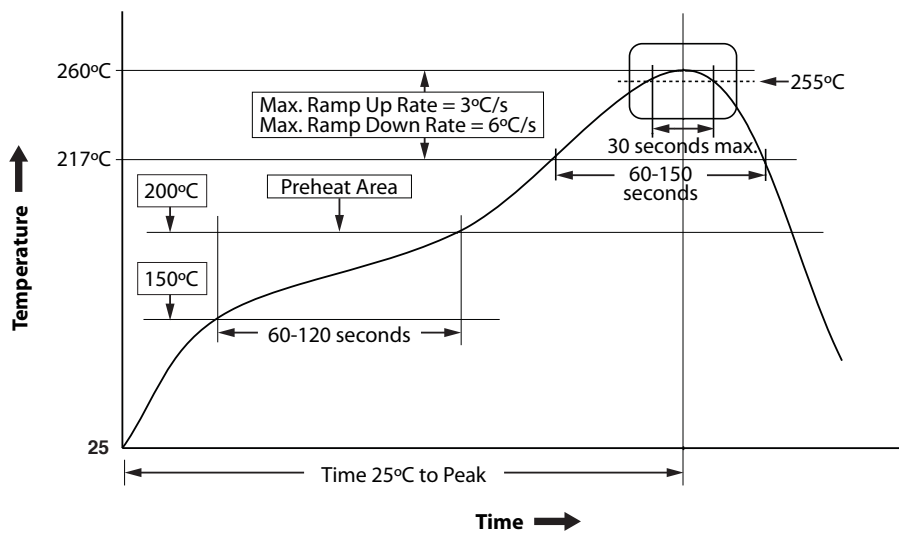

35 Suggested Solder Pad Layout

35.1 SOT -23-3 Solder Pad Layout

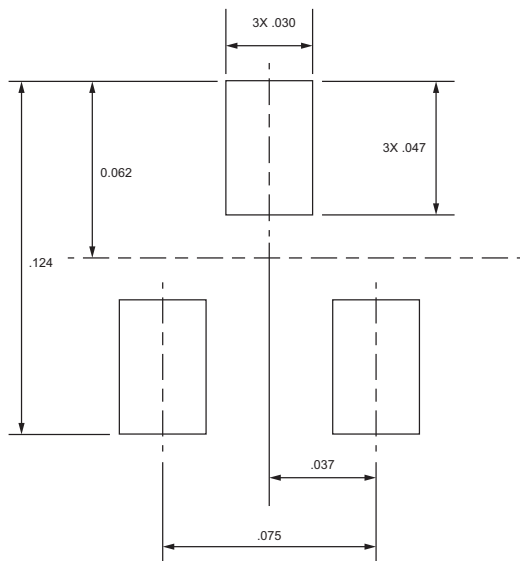

35.2 LGA-4 Solder Pad Layout

