

SERPAC RB85X06Y10Y

Electronic Enclosures

2

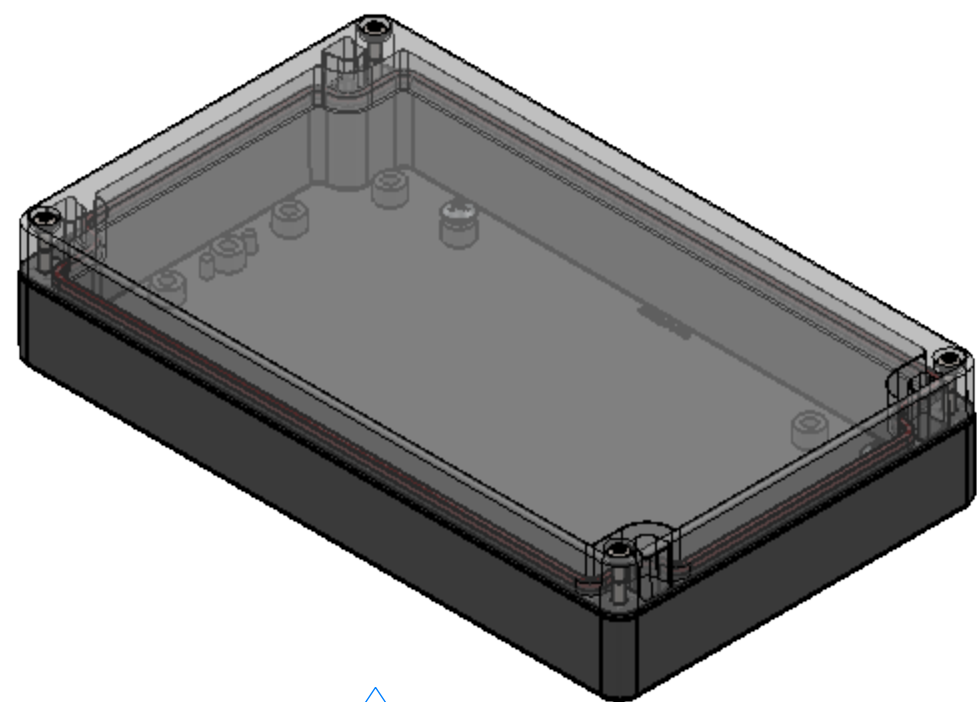
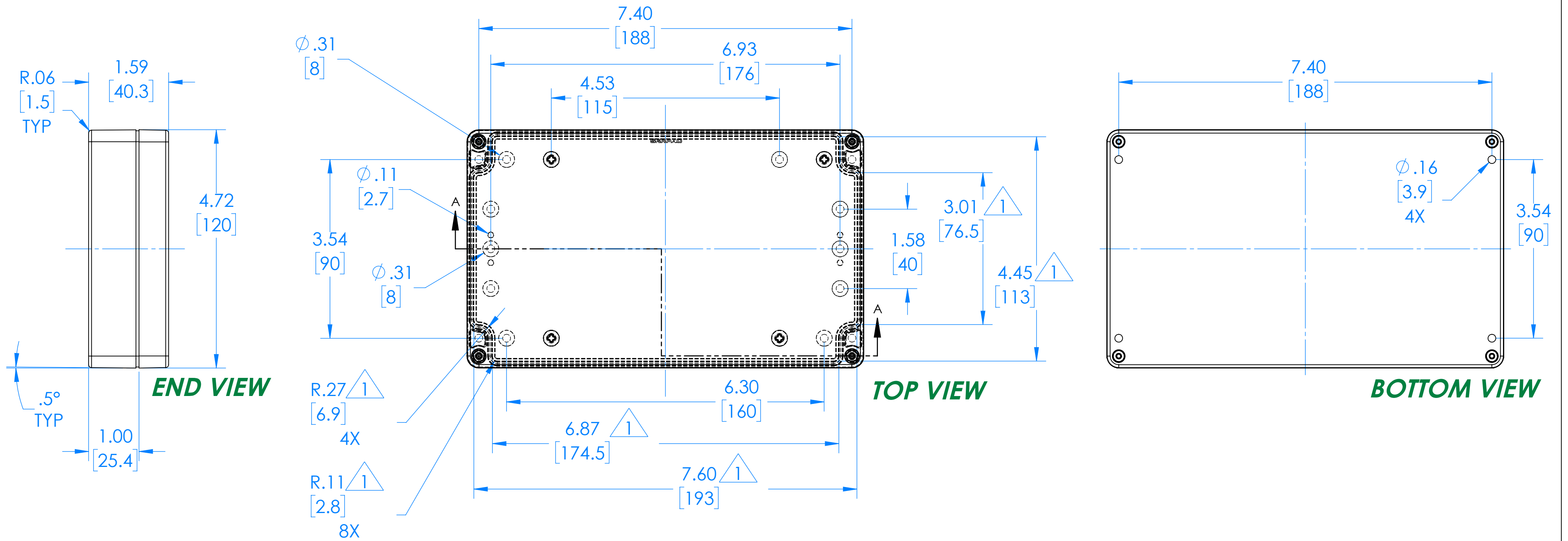

RB85X06C10B 2
 (Part shown, no material (X) specified)

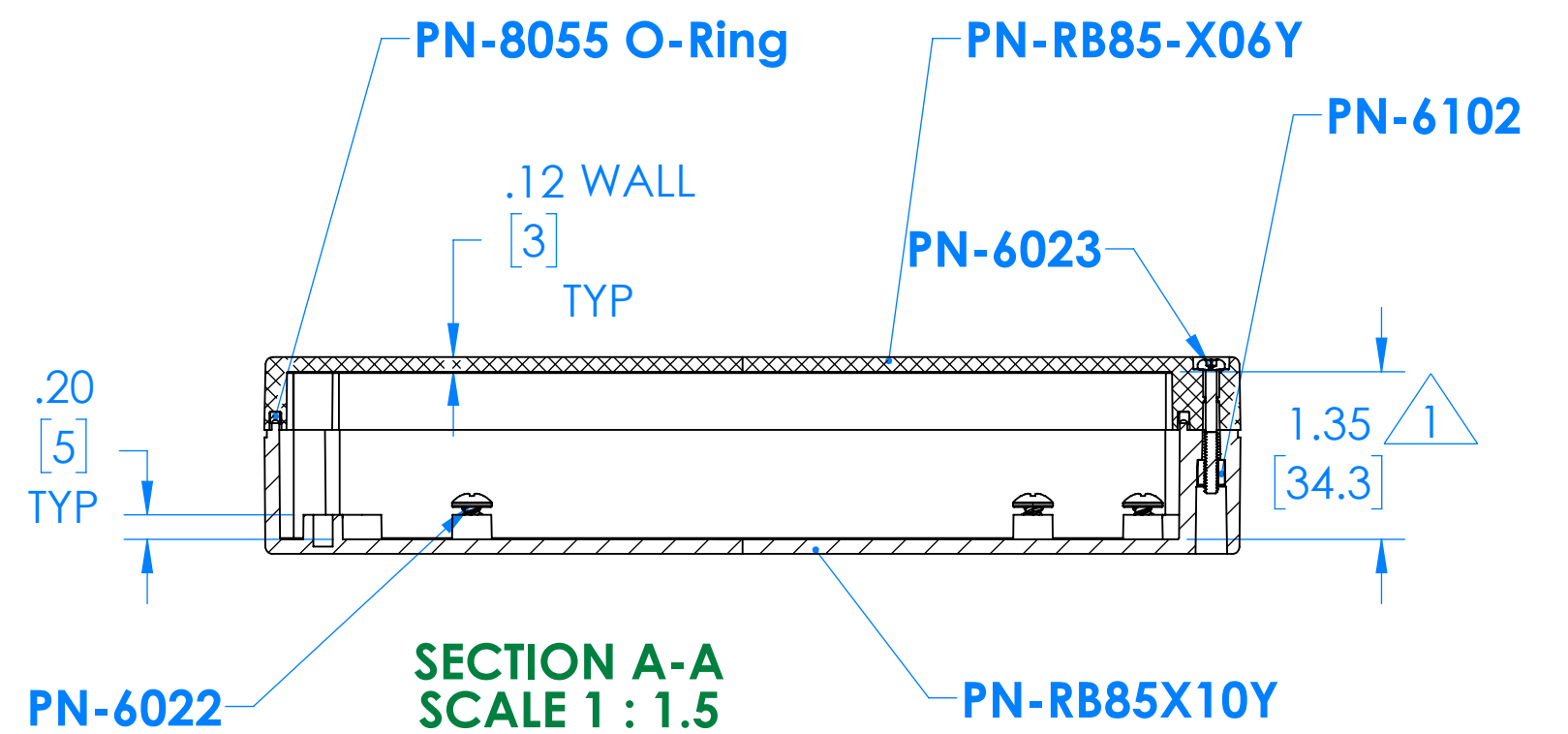

PN	Description
RB85-X06Y	(1) RB85-X06Y, Top
RB85X10Y	(1) RB85X10Y, Bottom
8085	(1) RB85 O-Ring
6023	(4) #4-40 Torx 10 Hd Screw
6022	(4) #10 High/Low Pan Hd x 1/4"
6102	(4) #4-40 Threaded Insert

1 = INTERIOR DIMENSIONS (@ BOTTOM)
 2 = STANDARD COLORS (Y) ARE: BLACK (B), CLEAR (C) AND GRAY (G)
 TOPS AND BOTTOMS ALL POSSIBLE COMBINATIONS AVAILABLE
 STANDARD MATERIALS (X) ARE: POLYCARBONATE (P) AND ABS (A)

-Watertight enclosure meets or exceed Nema 4 and or IP67.

DIMENSIONS in Inch [mm]