

# BAS16 series

## High-speed switching diodes

Rev. 6 — 24 September 2014

Product data sheet

## 1. Product profile

### 1.1 General description

High-speed switching diodes, encapsulated in small Surface-Mounted Device (SMD) plastic packages.

Table 1. Product overview

| Type number | Package  |       |          | Configuration   | Package configuration     |
|-------------|----------|-------|----------|-----------------|---------------------------|
|             | Nexperia | JEITA | JEDEC    |                 |                           |
| BAS16       | SOT23    | -     | TO-236AB | single          | small                     |
| BAS16H      | SOD123F  | -     | -        | single          | small and flat lead       |
| BAS16J      | SOD323F  | SC-90 | -        | single          | very small and flat lead  |
| BAS16L      | SOD882   | -     | -        | single          | leadless ultra small      |
| BAS16T      | SOT416   | SC-75 | -        | single          | ultra small               |
| BAS16VV     | SOT666   | -     | -        | triple isolated | ultra small and flat lead |
| BAS16VY     | SOT363   | SC-88 | -        | triple isolated | very small                |
| BAS16W      | SOT323   | SC-70 | -        | single          | very small                |
| BAS316      | SOD323   | SC-76 | -        | single          | very small                |
| BAS516      | SOD523   | SC-79 | -        | single          | ultra small and flat lead |

### 1.2 Features and benefits

- High switching speed:  $t_{rr} \leq 4$  ns
- Low leakage current
- Repetitive peak reverse voltage:  $V_{RRM} \leq 100$  V
- AEC-Q101 qualified
- Low capacitance
- Reverse voltage:  $V_R \leq 100$  V
- Small SMD plastic packages

### 1.3 Applications

- High-speed switching
- General-purpose switching

**1.4 Quick reference data**

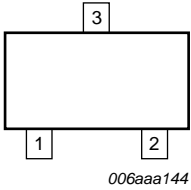
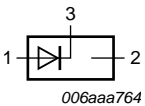
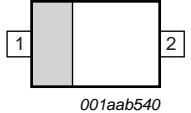
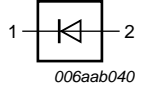
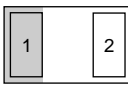
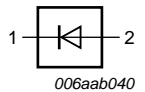
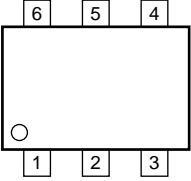
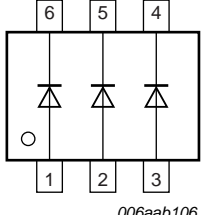
**Table 2. Quick reference data**

$T_{amb} = 25\text{ }^{\circ}\text{C}$  unless otherwise specified.

| Symbol           | Parameter             | Conditions  | Min | Typ | Max | Unit          |
|------------------|-----------------------|---|-----|-----|-----|---------------|
| <b>Per diode</b> |                       |   |     |     |     |               |
| $V_R$            | reverse voltage       |   | -   | -   | 100 | V             |
| $I_R$            | reverse current       | $V_R = 80\text{ V}$   | -   | -   | 0.5 | $\mu\text{A}$ |
| $t_{rr}$         | reverse recovery time | $I_F = 10\text{ mA}$ ; $I_R = 10\text{ mA}$ ;<br>$R_L = 100\text{ }\Omega$ ; $I_{R(\text{meas})} = 1\text{ mA}$ | -   | -   | 4   | ns            |

**2. Pinning information**

**Table 3. Pinning**

| Pin                                   | Description       |     | Simplified outline  | Graphic symbol   |
|---------------------------------------|-------------------|-----|---|--|
| <b>BAS16; BAS16T; BAS16W</b>          |                   |     |   |  |
| 1                                     | anode             |     |  <p>006aaa144</p>             |  <p>006aaa764</p>  |
| 2                                     | not connected     |     |   |  |
| 3                                     | cathode           |     |   |  |
| <b>BAS16H; BAS16J; BAS316; BAS516</b> |                   |     |   |  |
| 1                                     | cathode           | [1] |  <p>001aab540</p>            |  <p>006aab040</p> |
| 2                                     | anode             |     |   |  |
| <b>BAS16L</b>                         |                   |     |   |  |
| 1                                     | cathode           | [1] |  <p>Transparent top view</p> |  <p>006aab040</p> |
| 2                                     | anode             |     |   |  |
| <b>BAS16VV; BAS16VY</b>               |                   |     |   |  |
| 1                                     | anode (diode 1)   |     |  <p>001aab555</p>            |  <p>006aab106</p> |
| 2                                     | anode (diode 2)   |     |   |  |
| 3                                     | anode (diode 3)   |     |   |  |
| 4                                     | cathode (diode 3) |     |   |  |
| 5                                     | cathode (diode 2) |     |   |  |
| 6                                     | cathode (diode 1) |     |   |  |

[1] The marking bar indicates the cathode.

### 3. Ordering information

Table 4. Ordering information

| Type number | Package   |  | Version |
|-------------|-----------|--|---------|
|             | Name      | Description  |         |
| BAS16       | TO-236AB  | plastic surface-mounted package; 3 leads                                   | SOT23   |
| BAS16H      | -         | plastic surface-mounted package; 2 leads                                   | SOD123F |
| BAS16J      | SC-90     | plastic surface-mounted package; 2 leads                                   | SOD323F |
| BAS16L      | DFN1006-2 | leadless ultra small plastic package; 2 terminals; body 1.0 × 0.6 × 0.5 mm | SOD882  |
| BAS16T      | SC-75     | plastic surface-mounted package; 3 leads                                   | SOT416  |
| BAS16VV     | -         | plastic surface-mounted package; 6 leads                                   | SOT666  |
| BAS16VY     | SC-88     | plastic surface-mounted package; 6 leads                                   | SOT363  |
| BAS16W      | SC-70     | plastic surface-mounted package; 3 leads                                   | SOT323  |
| BAS316      | SC-76     | plastic surface-mounted package; 2 leads                                   | SOD323  |
| BAS516      | SC-79     | plastic surface-mounted package; 2 leads                                   | SOD523  |

### 4. Marking

Table 5. Marking codes

| Type number | Marking code <sup>[1]</sup> |
|-------------|-----------------------------|
| BAS16       | A6*                         |
| BAS16H      | A1                          |
| BAS16J      | AR                          |
| BAS16L      | S2                          |
| BAS16T      | A6                          |
| BAS16VV     | 53                          |
| BAS16VY     | 16*                         |
| BAS16W      | A6*                         |
| BAS316      | A6                          |
| BAS516      | 6                           |

[1] \* = placeholder for manufacturing site code

### 5. Limiting values

Table 6. Limiting values

In accordance with the Absolute Maximum Rating System (IEC 60134).

| Symbol           | Parameter                       | Conditions | Min | Max | Unit |
|------------------|---------------------------------|------------|-----|-----|------|
| <b>Per diode</b> |                                 |            |     |     |      |
| $V_{RRM}$        | repetitive peak reverse voltage |            | -   | 100 | V    |
| $V_R$            | reverse voltage                 |            | -   | 100 | V    |

**Table 6. Limiting values ...continued**  
*In accordance with the Absolute Maximum Rating System (IEC 60134).*

| Symbol            | Parameter                           | Conditions                                      |           | Min | Max  | Unit |
|-------------------|-------------------------------------|---|-----------|-----|------|------|
| I <sub>F</sub>    | forward current                     |   |           |     |      |      |
|                   | BAS16                               |   | [1]       | -   | 215  | mA   |
|                   | BAS16H<br>BAS16L                    |   | [2]       | -   | 215  | mA   |
|                   | BAS16T                              |   | [1]       | -   | 155  | mA   |
|                   | BAS16VV<br>BAS16VY                  |   | [1][3]    | -   | 200  | mA   |
|                   | BAS16W                              |   | [1]       | -   | 175  | mA   |
|                   | BAS16J<br>BAS316<br>BAS516          |   | [1]       | -   | 250  | mA   |
| I <sub>FRM</sub>  | repetitive peak forward current     | t <sub>p</sub> ≤ 0.5 ms;<br>δ ≤ 0.25            |           | -   | 500  | mA   |
| I <sub>FSM</sub>  | non-repetitive peak forward current | square wave;<br>T <sub>j(initial)</sub> = 25 °C |           |     |      |      |
|                   |                                     | t <sub>p</sub> = 1 μs                           |           | -   | 4    | A    |
|                   |                                     | t <sub>p</sub> = 1 ms                           |           | -   | 1    | A    |
|                   |                                     | t <sub>p</sub> = 1 s                            |           | -   | 0.5  | A    |
| P <sub>tot</sub>  | total power dissipation             |   |           |     |      |      |
|                   | BAS16                               | T <sub>amb</sub> ≤ 25 °C                        | [1]       | -   | 250  | mW   |
|                   | BAS16H                              | T <sub>amb</sub> ≤ 25 °C                        | [2]       | -   | 380  | mW   |
|                   |                                     |   | [5]       | -   | 830  | mW   |
|                   | BAS16J                              | T <sub>amb</sub> ≤ 25 °C                        | [5]       | -   | 550  | mW   |
|                   | BAS16L                              | T <sub>amb</sub> ≤ 25 °C                        | [2]       | -   | 250  | mW   |
|                   | BAS16T                              | T <sub>sp</sub> ≤ 90 °C                         | [1][4]    | -   | 170  | mW   |
|                   | BAS16VV                             | T <sub>amb</sub> ≤ 25 °C                        | [1][3]    | -   | 180  | mW   |
|                   | BAS16VY                             | T <sub>sp</sub> ≤ 85 °C                         | [1][3][6] | -   | 250  | mW   |
|                   | BAS16W                              | T <sub>amb</sub> ≤ 25 °C                        | [1]       | -   | 200  | mW   |
|                   | BAS316                              | T <sub>sp</sub> ≤ 90 °C                         | [1][4]    | -   | 400  | mW   |
| BAS516            | T <sub>sp</sub> ≤ 90 °C             | [1][4]  | -         | 500 | mW   |      |
| <b>Per device</b> |                                     |   |           |     |      |      |
| T <sub>j</sub>    | junction temperature                |   |           | -   | 150  | °C   |
| T <sub>amb</sub>  | ambient temperature                 |   |           | -65 | +150 | °C   |
| T <sub>stg</sub>  | storage temperature                 |   |           | -65 | +150 | °C   |

[1] Device mounted on an FR4 Printed-Circuit Board (PCB), single-sided copper, tin-plated and standard footprint.

[2] Device mounted on an FR4 PCB with 60 μm copper strip line.

[3] Single diode loaded.

[4] Soldering point of cathode tab.

[5] Device mounted on an FR4 PCB, single-sided copper, tin-plated, mounting pad for cathode 1 cm<sup>2</sup>.

[6] Soldering points at pins 4, 5 and 6.

## 6. Thermal characteristics

Table 7. Thermal characteristics

| Symbol         | Parameter  | Conditions  | Min    | Typ | Max     | Unit    |
|----------------|--|-------------|--------|-----|---------|---------|
| $R_{th(j-a)}$  | thermal resistance from junction to ambient      | in free air |        |     |         |         |
|                | BAS16  |             | [1]    | -   | -       | 500 K/W |
|                | BAS16H   |             | [2]    | -   | -       | 330 K/W |
|                |  |             | [3]    | -   | -       | 150 K/W |
|                | BAS16J   |             | [3]    | -   | -       | 230 K/W |
|                | BAS16L   |             | [2]    | -   | -       | 500 K/W |
|                | BAS16VV  |             | [2][4] | -   | -       | 700 K/W |
|                |  |             | [3][4] | -   | -       | 410 K/W |
| BAS16W         |  | [1]         | -      | -   | 625 K/W |         |
| $R_{th(j-sp)}$ | thermal resistance from junction to solder point |             |        |     |         |         |
|                | BAS16  |             | -      | -   | 330 K/W |         |
|                | BAS16H   |             | [5]    | -   | -       | 70 K/W  |
|                | BAS16J   |             | [5]    | -   | -       | 55 K/W  |
|                | BAS16T   |             | -      | -   | 350 K/W |         |
|                | BAS16VY  |             | [4][6] | -   | -       | 260 K/W |
|                | BAS16W   |             | -      | -   | 300 K/W |         |
|                | BAS316   |             | [5]    | -   | -       | 150 K/W |
|                | BAS516   |             | [5]    | -   | -       | 120 K/W |

[1] Device mounted on an FR4 PCB, single-sided copper, tin-plated and standard footprint.

[2] Device mounted on an FR4 PCB with 60  $\mu\text{m}$  copper strip line.

[3] Device mounted on an FR4 PCB, single-sided copper, tin-plated, mounting pad for cathode 1  $\text{cm}^2$ .

[4] Single diode loaded.

[5] Soldering point of cathode tab.

[6] Soldering points at pins 4, 5 and 6.

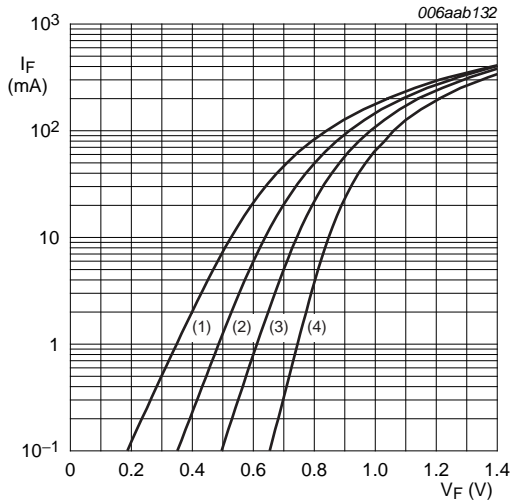
## 7. Characteristics

**Table 8. Characteristics**

$T_{amb} = 25\text{ °C}$  unless otherwise specified.

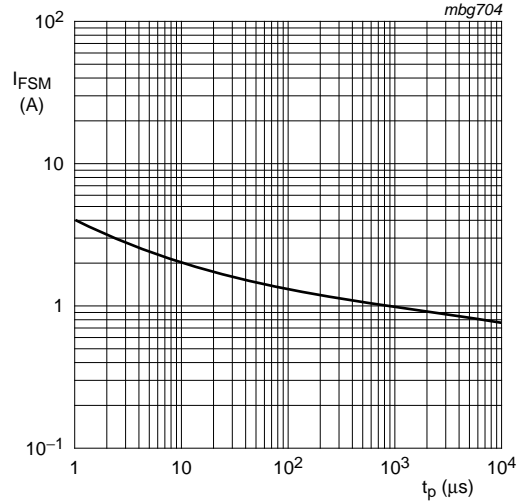
| Symbol           | Parameter   | Conditions  | Min | Typ | Max  | Unit          |
|------------------|---|---|-----|-----|------|---------------|
| <b>Per diode</b> |   |   |     |     |      |               |
| $V_F$            | forward voltage   |   | [1] |     |      |               |
|                  |   | $I_F = 1\text{ mA}$   | -   | -   | 715  | mV            |
|                  |   | $I_F = 10\text{ mA}$  | -   | -   | 855  | mV            |
|                  |   | $I_F = 50\text{ mA}$  | -   | -   | 1    | V             |
| $I_R$            | reverse current   | $V_R = 25\text{ V}$   | -   | -   | 30   | nA            |
|                  |   | $V_R = 80\text{ V}$   | -   | -   | 0.5  | $\mu\text{A}$ |
|                  |   | $V_R = 25\text{ V}; T_j = 150\text{ °C}$  | -   | -   | 30   | $\mu\text{A}$ |
|                  |   | $V_R = 80\text{ V}; T_j = 150\text{ °C}$  | -   | -   | 50   | $\mu\text{A}$ |
| $C_d$            | diode capacitance   | $f = 1\text{ MHz}; V_R = 0\text{ V}$  |     |     |      |               |
|                  | BAS16; BAS16H;<br>BAS16J; BAS16L;<br>BAS16T; BAS16VV;<br>BAS16VY; BAS16W;<br>BAS316 |   | -   | -   | 1.5  | pF            |
|                  | BAS516  |   | -   | -   | 1    | pF            |
| $t_{rr}$         | reverse recovery time   | $I_F = 10\text{ mA}; I_R = 10\text{ mA};$<br>$R_L = 100\ \Omega;$<br>$I_{R(\text{meas})} = 1\text{ mA}$ | -   | -   | 4    | ns            |
| $V_{FR}$         | forward recovery voltage  | $I_F = 10\text{ mA}; t_r = 20\text{ ns}$  | -   | -   | 1.75 | V             |

[1] Pulse test:  $t_p \leq 300\ \mu\text{s}; \delta \leq 0.02$ .



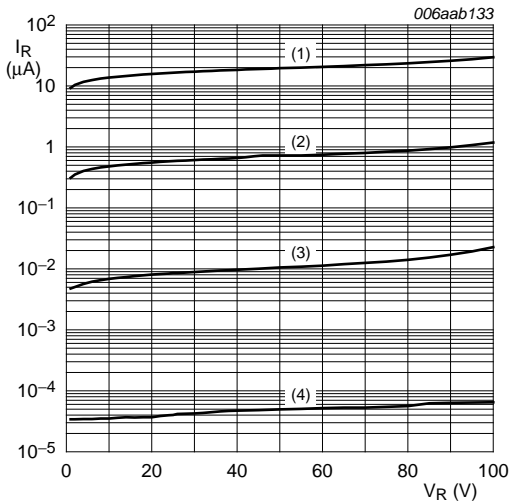
- (1)  $T_{amb} = 150\text{ }^\circ\text{C}$
- (2)  $T_{amb} = 85\text{ }^\circ\text{C}$
- (3)  $T_{amb} = 25\text{ }^\circ\text{C}$
- (4)  $T_{amb} = -40\text{ }^\circ\text{C}$

**Fig 1. Forward current as a function of forward voltage; typical values**



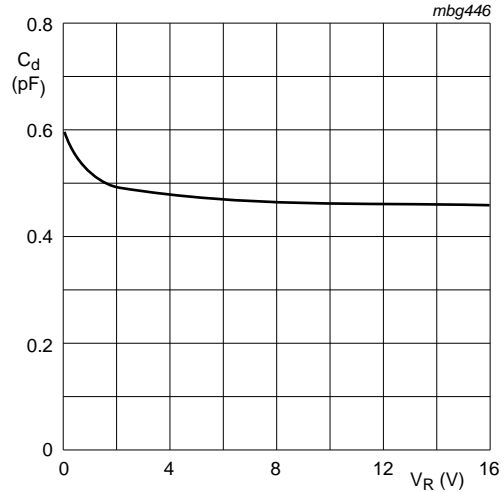
Based on square wave currents.  
 $T_{j(\text{init})} = 25\text{ }^\circ\text{C}$

**Fig 2. Non-repetitive peak forward current as a function of pulse duration; maximum values**



- (1)  $T_{amb} = 150\text{ }^\circ\text{C}$
- (2)  $T_{amb} = 85\text{ }^\circ\text{C}$
- (3)  $T_{amb} = 25\text{ }^\circ\text{C}$
- (4)  $T_{amb} = -40\text{ }^\circ\text{C}$

**Fig 3. Reverse current as a function of reverse voltage; typical values**



$f = 1\text{ MHz}$ ;  $T_{amb} = 25\text{ }^\circ\text{C}$

**Fig 4. Diode capacitance as a function of reverse voltage; typical values**

**8. Test information**



(1)  $I_R = 1 \text{ mA}$

Input signal: reverse pulse rise time  $t_r = 0.6 \text{ ns}$ ; reverse voltage pulse duration  $t_p = 100 \text{ ns}$ ; duty cycle  $\delta = 0.05$

Oscilloscope: rise time  $t_r = 0.35 \text{ ns}$

**Fig 5. Reverse recovery time test circuit and waveforms**



Input signal: forward pulse rise time  $t_r = 20 \text{ ns}$ ; forward current pulse duration  $t_p \geq 100 \text{ ns}$ ; duty cycle  $\delta \leq 0.005$

**Fig 6. Forward recovery voltage test circuit and waveforms**

**8.1 Quality information**

This product has been qualified in accordance with the Automotive Electronics Council (AEC) standard Q101 - *Stress test qualification for discrete semiconductors*, and is suitable for use in automotive applications.



**9. Package outline**





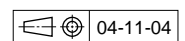
Dimensions in mm



**Fig 13. Package outline BAS16VY (SOT363)**



Dimensions in mm



**Fig 14. Package outline BAS16W (SOT323/SC-70)**



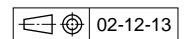
Dimensions in mm



**Fig 15. Package outline BAS316 (SOD323/SC-76)**

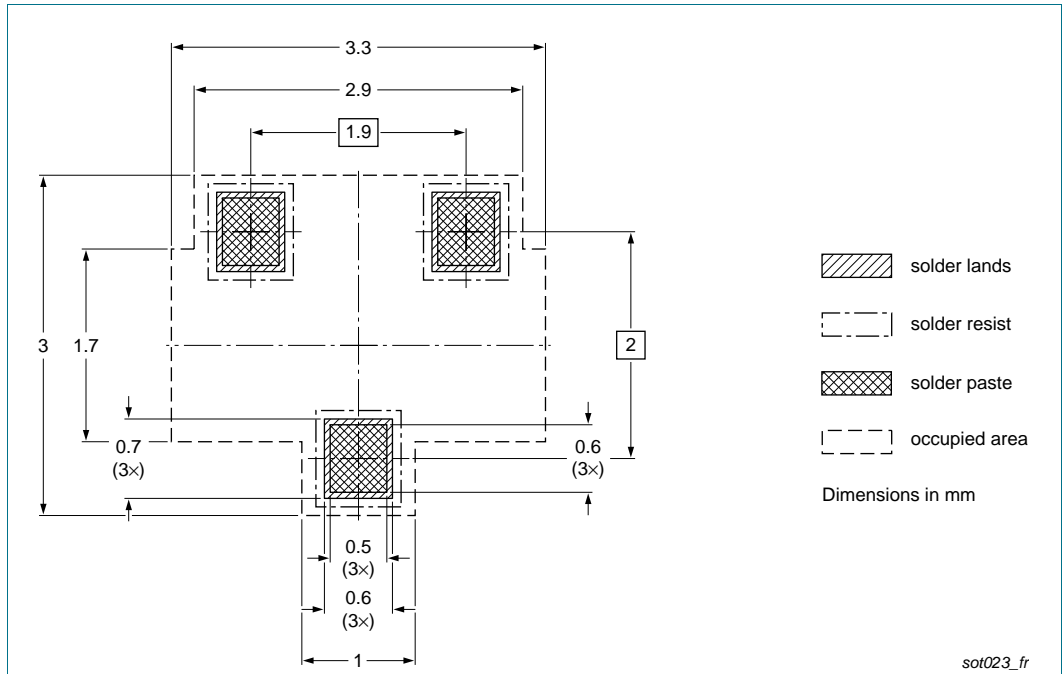


Dimensions in mm

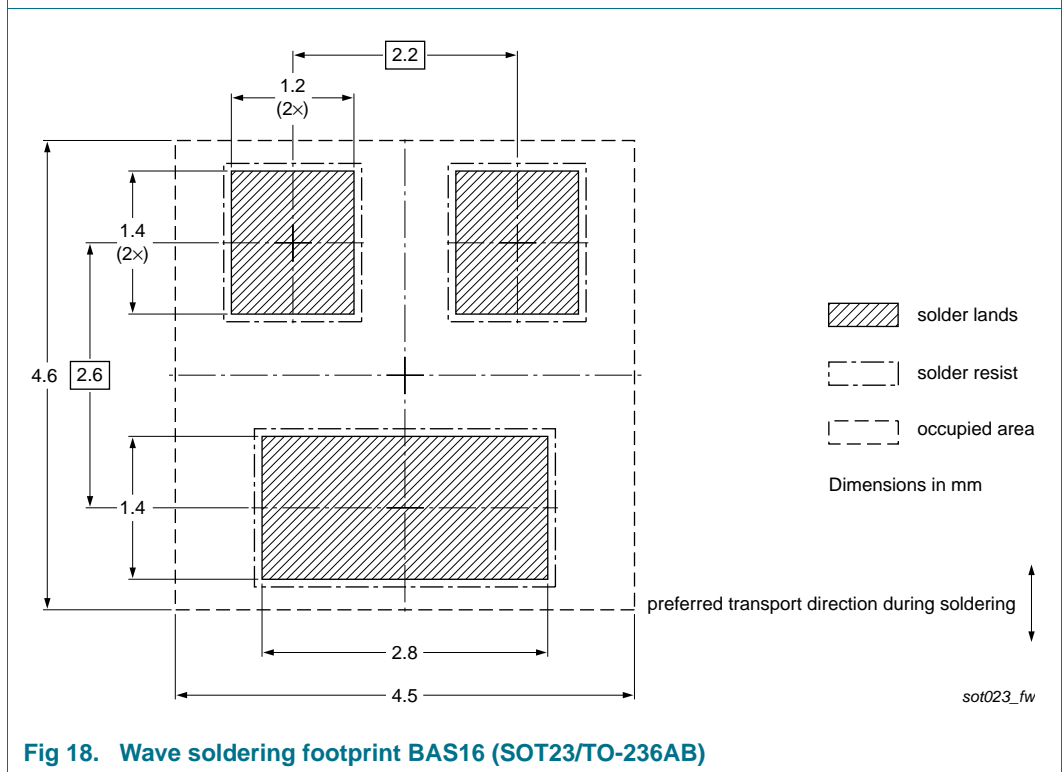


**Fig 16. Package outline BAS516 (SOD523/SC-79)**

**10. Soldering**

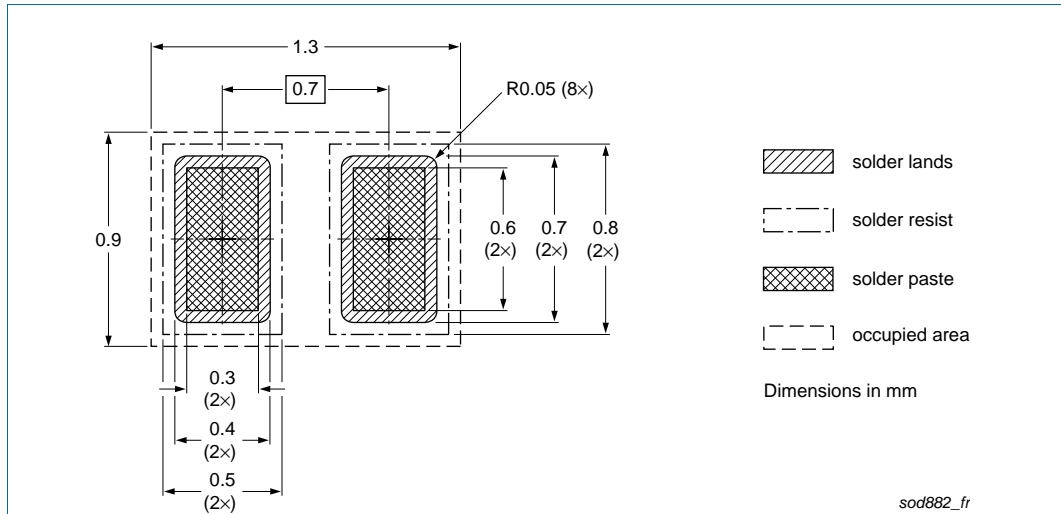


**Fig 17. Reflow soldering footprint BAS16 (SOT23/TO-236AB)**

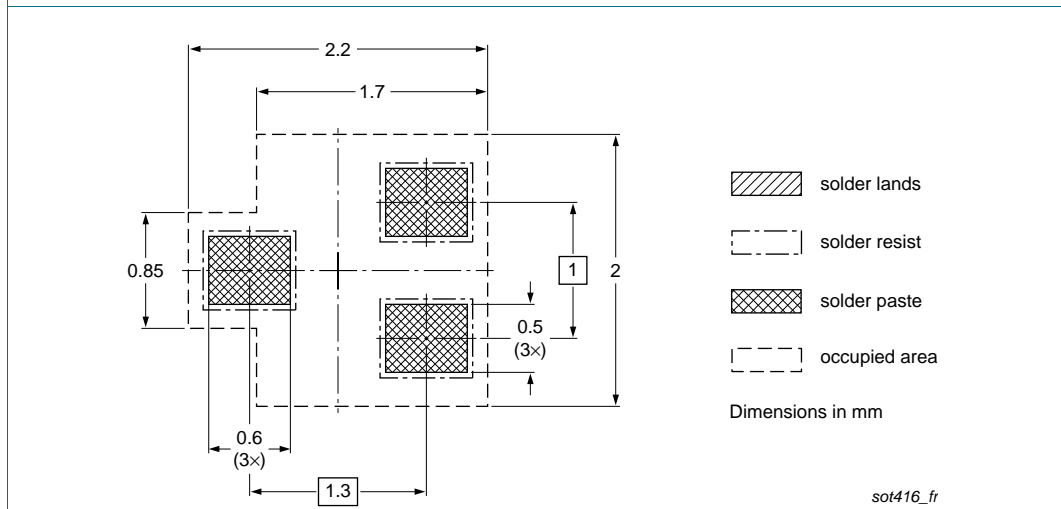


**Fig 18. Wave soldering footprint BAS16 (SOT23/TO-236AB)**





**Fig 21. Reflow soldering footprint BAS16L (SOD882/DFN1006-2)**



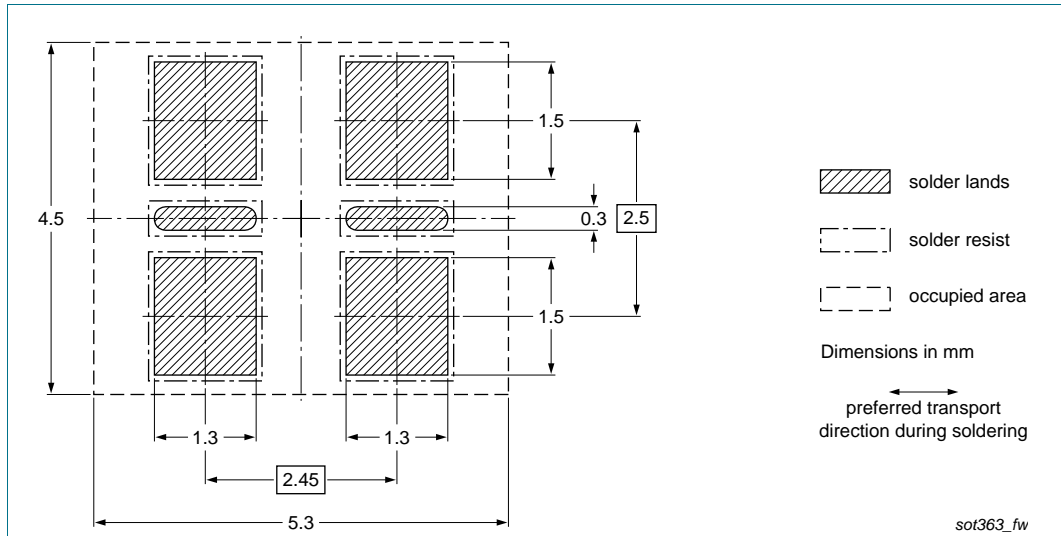
**Fig 22. Reflow soldering footprint BAS16T (SOT416/SC-75)**



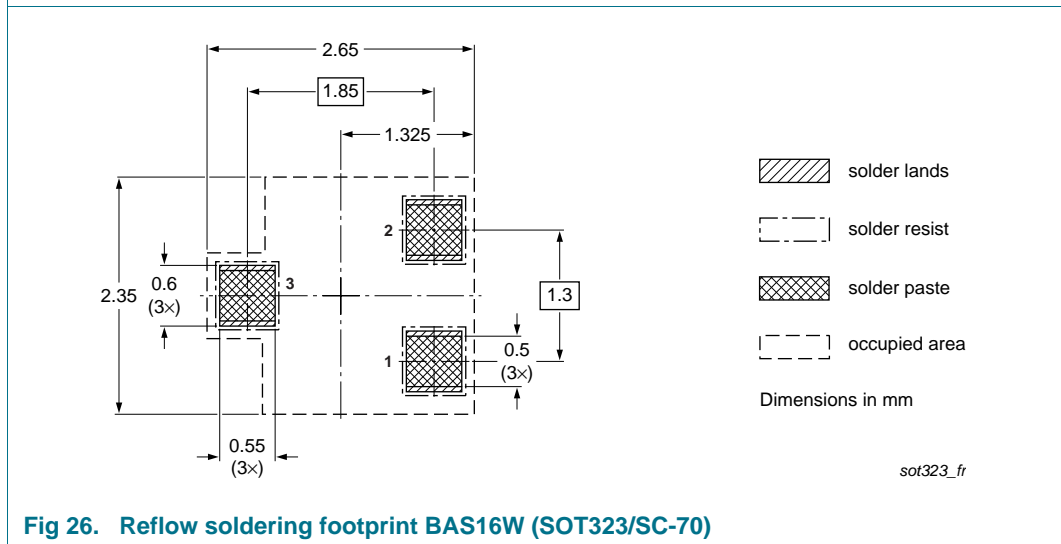
**Fig 23. Reflow soldering footprint BAS16VV (SOT666)**



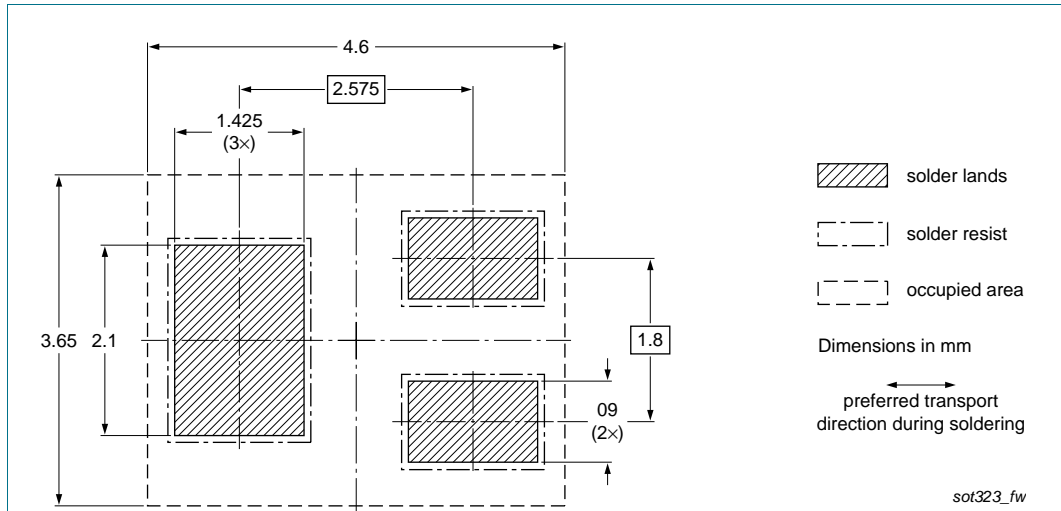
**Fig 24. Reflow soldering footprint BAS16VY (SOT363/SC-88)**



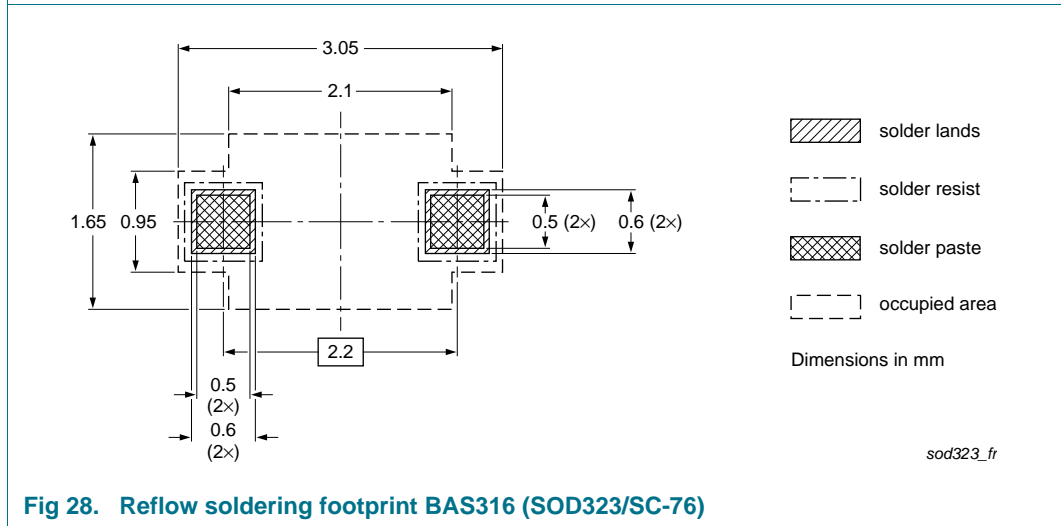
**Fig 25. Wave soldering footprint BAS16VY (SOT363/SC-88)**



**Fig 26. Reflow soldering footprint BAS16W (SOT323/SC-70)**



**Fig 27. Wave soldering footprint BAS16W (SOT323/SC-70)**

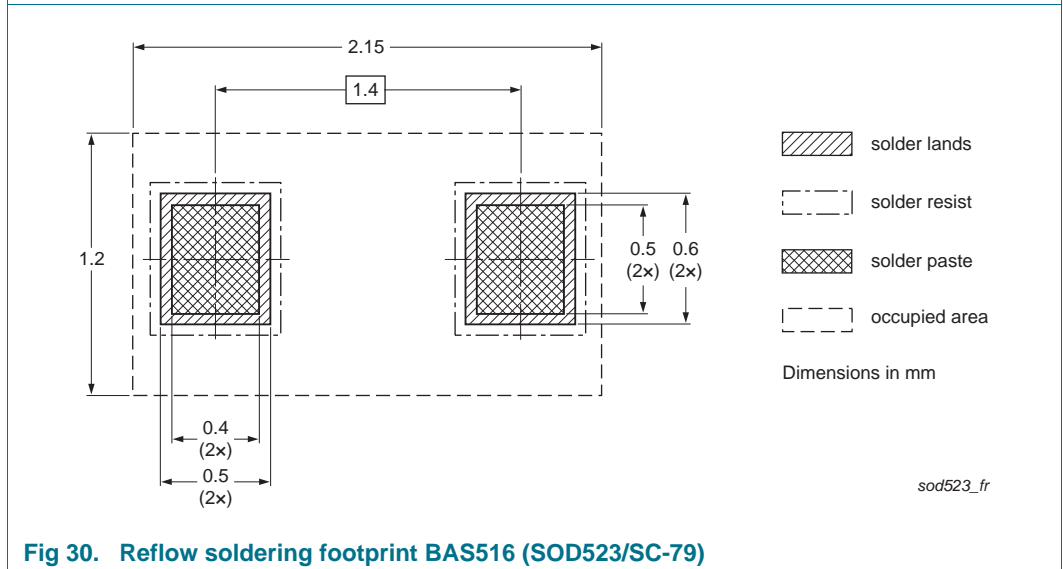


**Fig 28. Reflow soldering footprint BAS316 (SOD323/SC-76)**





**Fig 29. Wave soldering footprint BAS316 (SOD323/SC-76)**



**Fig 30. Reflow soldering footprint BAS516 (SOD523/SC-79)**

## 11. Revision history

Table 9. Revision history

| Document ID       | Release date   | Data sheet status     | Change notice | Supersedes   |
|-------------------|--|-----------------------|---------------|--|
| BAS16_SER_6       | 20140924   | Product data sheet    | -             | BAS16_SER_5  |
| Modifications:    | <ul style="list-style-type: none"> <li>• <a href="#">Section 1.2 “Features and benefits”</a>: updated</li> <li>• <a href="#">Section 4 “Marking”</a>: updated</li> <li>• <a href="#">Table 6 “Limiting values”</a>: updated</li> <li>• <a href="#">Section 8 “Test information”</a>: updated</li> <li>• <a href="#">Section 12 “Legal information”</a>: updated</li> </ul> |                       |               |  |
| BAS16_SER_5       | 20080825   | Product data sheet    | -             | BAS16_4<br>BAS16H_1<br>BAS16J_1<br>BAS16L_1<br>BAS16T_1<br>BAS16VV_BAS16VY_3<br>BAS16W_4<br>BAS316_4<br>BAS516_1 |
| BAS16_4           | 20011010   | Product specification | -             | BAS16_3  |
| BAS16H_1          | 20050415   | Product data sheet    | -             | -  |
| BAS16J_1          | 20070308   | Product data sheet    | -             | -  |
| BAS16L_1          | 20030623   | Product specification | -             | -  |
| BAS16T_1          | 19980120   | Product specification | -             | -  |
| BAS16VV_BAS16VY_3 | 20070420   | Product data sheet    | -             | BAS16VV_BAS16VY_2  |
| BAS16W_4          | 19990506   | Product specification | -             | BAS16W_3   |
| BAS316_4          | 20040204   | Product specification | -             | BAS316_3   |
| BAS516_1          | 19980831   | Product specification | -             | -  |

## 12. Legal information

### 12.1 Data sheet status

| Document status <sup>[1][2]</sup> | Product status <sup>[3]</sup> | Definition  |
|-----------------------------------|-------------------------------|---|
| Objective [short] data sheet      | Development                   | This document contains data from the objective specification for product development. |
| Preliminary [short] data sheet    | Qualification                 | This document contains data from the preliminary specification.                       |
| Product [short] data sheet        | Production                    | This document contains the product specification.                                     |

[1] Please consult the most recently issued document before initiating or completing a design.

[2] The term 'short data sheet' is explained in section "Definitions".

[3] The product status of device(s) described in this document may have changed since this document was published and may differ in case of multiple devices. The latest product status information is available on the Internet at URL <http://www.nexperia.com>.

### 12.2 Definitions

**Draft** — The document is a draft version only. The content is still under internal review and subject to formal approval, which may result in modifications or additions. Nexperia does not give any representations or warranties as to the accuracy or completeness of information included herein and shall have no liability for the consequences of use of such information.

**Short data sheet** — A short data sheet is an extract from a full data sheet with the same product type number(s) and title. A short data sheet is intended for quick reference only and should not be relied upon to contain detailed and full information. For detailed and full information see the relevant full data sheet, which is available on request via the local Nexperia sales office. In case of any inconsistency or conflict with the short data sheet, the full data sheet shall prevail.

**Product specification** — The information and data provided in a Product data sheet shall define the specification of the product as agreed between Nexperia and its customer, unless Nexperia and customer have explicitly agreed otherwise in writing. In no event however, shall an agreement be valid in which the Nexperia product is deemed to offer functions and qualities beyond those described in the Product data sheet.

### 12.3 Disclaimers

**Limited warranty and liability** — Information in this document is believed to be accurate and reliable. However, Nexperia does not give any representations or warranties, expressed or implied, as to the accuracy or completeness of such information and shall have no liability for the consequences of use of such information. Nexperia takes no responsibility for the content in this document if provided by an information source outside of Nexperia.

In no event shall Nexperia be liable for any indirect, incidental, punitive, special or consequential damages (including - without limitation - lost profits, lost savings, business interruption, costs related to the removal or replacement of any products or rework charges) whether or not such damages are based on tort (including negligence), warranty, breach of contract or any other legal theory.

Notwithstanding any damages that customer might incur for any reason whatsoever, Nexperia's aggregate and cumulative liability towards customer for the products described herein shall be limited in accordance with the *Terms and conditions of commercial sale* of Nexperia.

**Right to make changes** — Nexperia reserves the right to make changes to information published in this document, including without limitation specifications and product descriptions, at any time and without notice. This document supersedes and replaces all information supplied prior to the publication hereof.

**Suitability for use in automotive applications** — This Nexperia product has been qualified for use in automotive applications. Unless otherwise agreed in writing, the product is not designed, authorized or warranted to be suitable for use in life support, life-critical or safety-critical systems or equipment, nor in applications where failure or malfunction of a Nexperia product can reasonably be expected to result in personal injury, death or severe property or environmental damage. Nexperia and its suppliers accept no liability for inclusion and/or use of Nexperia products in such equipment or applications and therefore such inclusion and/or use is at the customer's own risk.

**Applications** — Applications that are described herein for any of these products are for illustrative purposes only. Nexperia makes no representation or warranty that such applications will be suitable for the specified use without further testing or modification.

Customers are responsible for the design and operation of their applications and products using Nexperia products, and Nexperia accepts no liability for any assistance with applications or customer product design. It is customer's sole responsibility to determine whether the Nexperia product is suitable and fit for the customer's applications and products planned, as well as for the planned application and use of customer's third party customer(s). Customers should provide appropriate design and operating safeguards to minimize the risks associated with their applications and products.

Nexperia does not accept any liability related to any default, damage, costs or problem which is based on any weakness or default in the customer's applications or products, or the application or use by customer's third party customer(s). Customer is responsible for doing all necessary testing for the customer's applications and products using Nexperia products in order to avoid a default of the applications and the products or of the application or use by customer's third party customer(s). Nexperia does not accept any liability in this respect.

**Limiting values** — Stress above one or more limiting values (as defined in the Absolute Maximum Ratings System of IEC 60134) will cause permanent damage to the device. Limiting values are stress ratings only and (proper) operation of the device at these or any other conditions above those given in the Recommended operating conditions section (if present) or the Characteristics sections of this document is not warranted. Constant or repeated exposure to limiting values will permanently and irreversibly affect the quality and reliability of the device.

**Terms and conditions of commercial sale** — Nexperia products are sold subject to the general terms and conditions of commercial sale, as published at <http://www.nexperia.com/profile/terms>, unless otherwise agreed in a valid written individual agreement. In case an individual agreement is concluded only the terms and conditions of the respective agreement shall apply. Nexperia hereby expressly objects to applying the customer's general terms and conditions with regard to the purchase of Nexperia products by customer.

**No offer to sell or license** — Nothing in this document may be interpreted or construed as an offer to sell products that is open for acceptance or the grant, conveyance or implication of any license under any copyrights, patents or other industrial or intellectual property rights.

**Export control** — This document as well as the item(s) described herein may be subject to export control regulations. Export might require a prior authorization from competent authorities.

**Quick reference data** — The Quick reference data is an extract of the product data given in the Limiting values and Characteristics sections of this document, and as such is not complete, exhaustive or legally binding.

**Translations** — A non-English (translated) version of a document is for reference only. The English version shall prevail in case of any discrepancy between the translated and English versions.

## 12.4 Trademarks

Notice: All referenced brands, product names, service names and trademarks are the property of their respective owners.

## 13. Contact information

---

For more information, please visit: <http://www.nexperia.com>

For sales office addresses, please send an email to: [salesaddresses@nexperia.com](mailto:salesaddresses@nexperia.com)

## 14. Contents

---

|           |  |           |
|-----------|--|-----------|
| <b>1</b>  | <b>Product profile</b> . . . . .         | <b>1</b>  |
| 1.1       | General description . . . . .            | 1         |
| 1.2       | Features and benefits . . . . .          | 1         |
| 1.3       | Applications . . . . .                   | 1         |
| 1.4       | Quick reference data . . . . .           | 2         |
| <b>2</b>  | <b>Pinning information</b> . . . . .     | <b>2</b>  |
| <b>3</b>  | <b>Ordering information</b> . . . . .    | <b>3</b>  |
| <b>4</b>  | <b>Marking</b> . . . . .                 | <b>3</b>  |
| <b>5</b>  | <b>Limiting values</b> . . . . .         | <b>3</b>  |
| <b>6</b>  | <b>Thermal characteristics</b> . . . . . | <b>5</b>  |
| <b>7</b>  | <b>Characteristics</b> . . . . .         | <b>6</b>  |
| <b>8</b>  | <b>Test information</b> . . . . .        | <b>8</b>  |
| 8.1       | Quality information . . . . .            | 8         |
| <b>9</b>  | <b>Package outline</b> . . . . .         | <b>9</b>  |
| <b>10</b> | <b>Soldering</b> . . . . .               | <b>11</b> |
| <b>11</b> | <b>Revision history</b> . . . . .        | <b>18</b> |
| <b>12</b> | <b>Legal information</b> . . . . .       | <b>19</b> |
| 12.1      | Data sheet status . . . . .              | 19        |
| 12.2      | Definitions . . . . .                    | 19        |
| 12.3      | Disclaimers . . . . .                    | 19        |
| 12.4      | Trademarks . . . . .                     | 20        |
| <b>13</b> | <b>Contact information</b> . . . . .     | <b>20</b> |
| <b>14</b> | <b>Contents</b> . . . . .                | <b>21</b> |