

4W LED Driver Demoboard with Accurate Average-Mode Constant Current Control

General Description

The HV9967BDB1 demoboard is a high-brightness LED driver designed to drive 4 LEDs in series at currents up to 350mA from a 20 - 60V DC input. The demoboard uses the Supertex's HV9967B in a buck configuration in a constant off-time mode.

The HV9967BDB1 LED driver features tight regulation of the LED current within a few milliamps over the entire range of the input voltage (i.e. 20 - 60VDC). The LED current accuracy is almost insensitive to the passive component tolerances, such as the output filter inductance or the timing resistor.

PWM dimming can be achieved by applying a pulse-width-modulated square wave signal between the PWMD and GND pins.

Specifications

Parameter	Specification
Input voltage	20 - 60 VDC
Output voltage	10 -15VDC (4 x LEDs)
Output current	350mA \pm 5%
Output current ripple	20% pk-pk (Typical, depending on the type of LED)
Switching frequency	Variable with constant $T_{OFF} = 5\mu s \pm 20\%$
Full load efficiency	Typical 80% minimum
Output short circuit protection	Included, hiccup mode

Connection Diagram

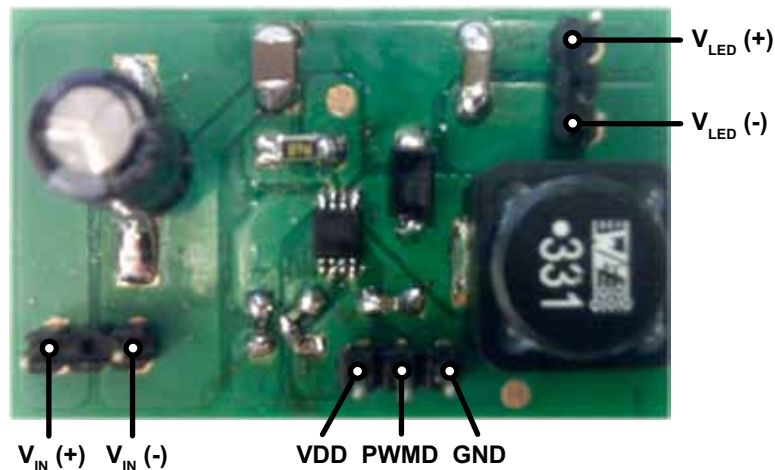

Connections

1. Connect the LED string between LED+ (Anode of LED string) and LED- (Cathode of LED string).
2. Connect the PWMD terminal to the VDD terminal to enable the LED driver if PWM dimming is not required.
3. Connect the input DC voltage between the VIN+ and VIN- terminals.

Circuit Schematic

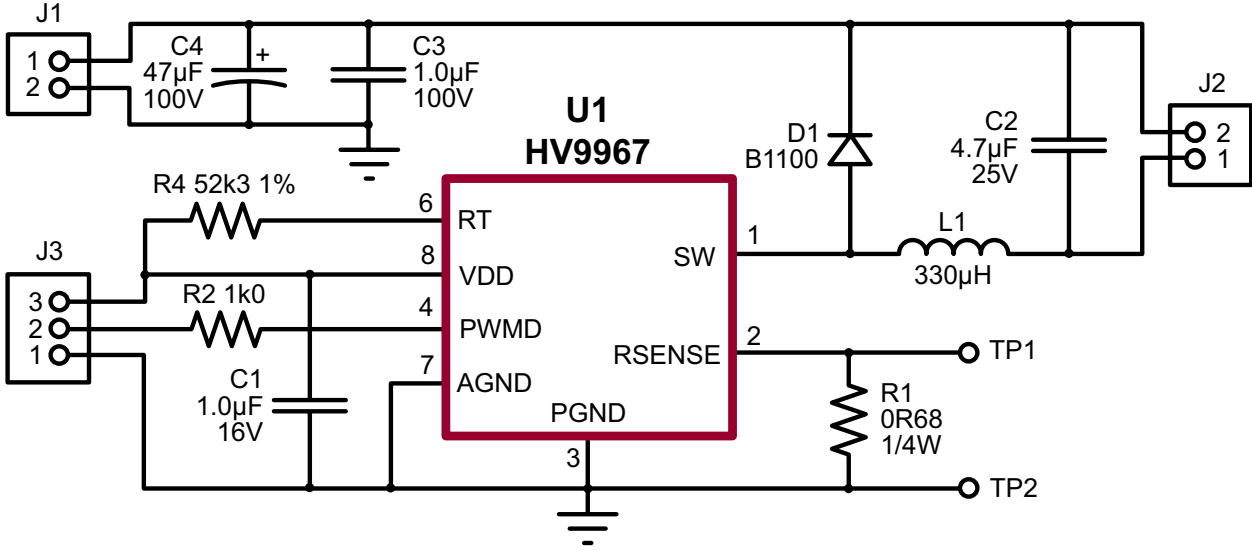

Typical Characteristics

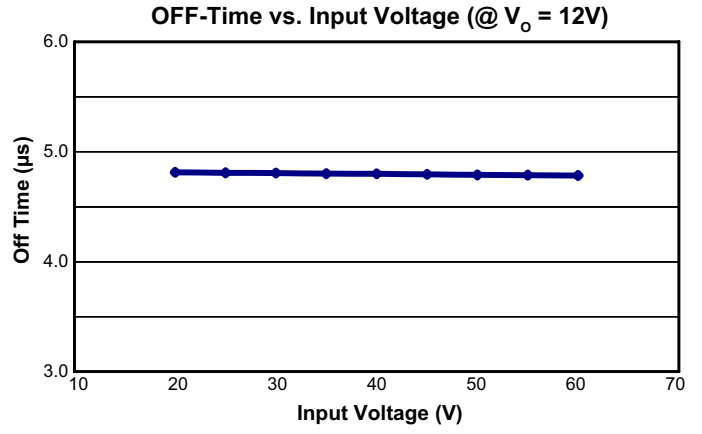
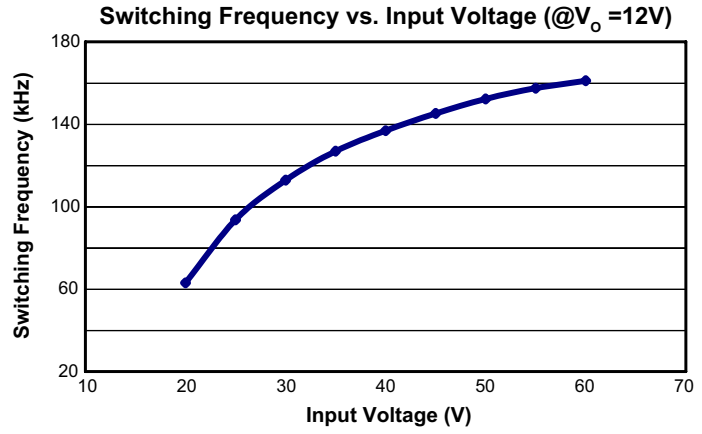
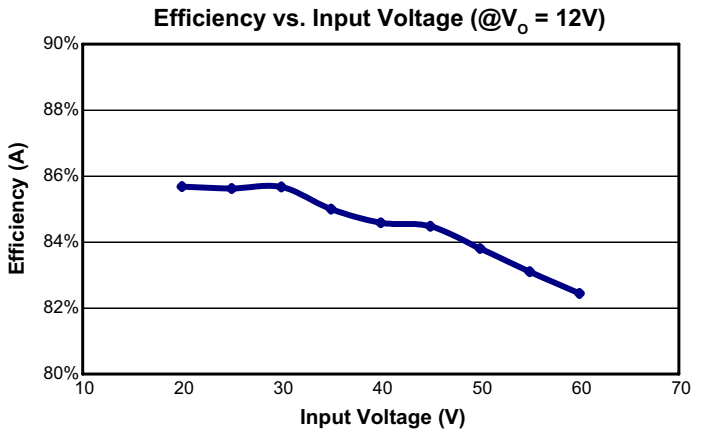
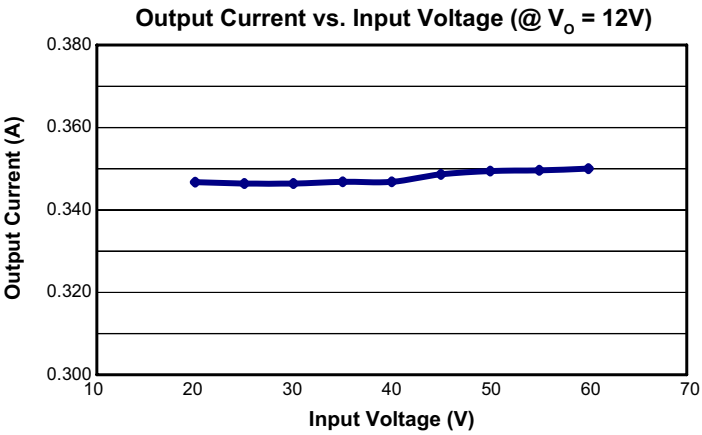

Normal Operation:

Fig.1-4 shows the waveforms during normal operation at loading of 4 x LED in series at different input.

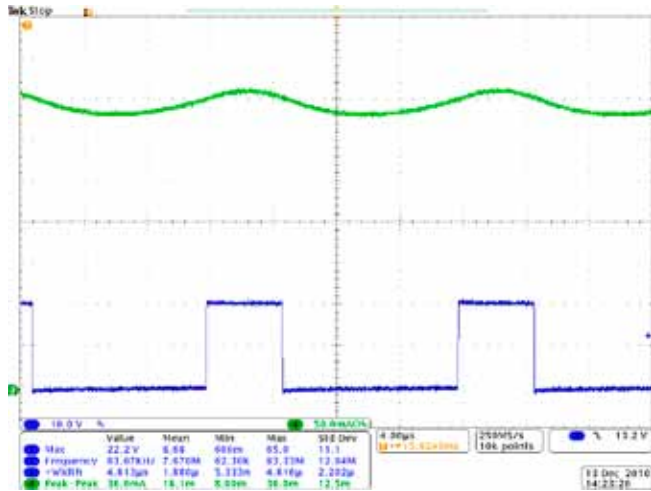

Fig.1: 20V Input

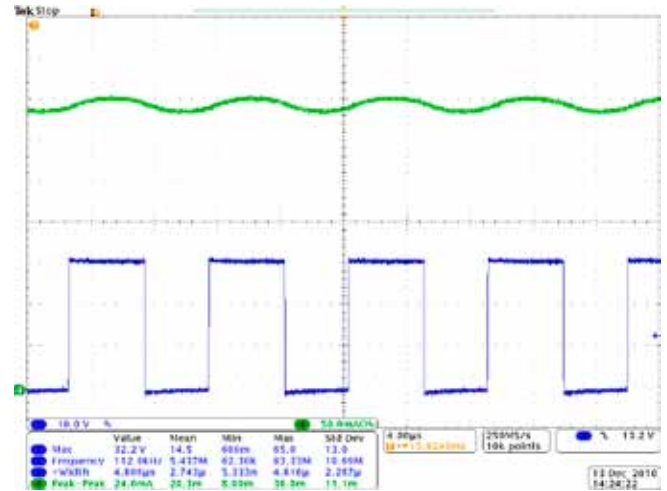

Fig.2: 30V Input

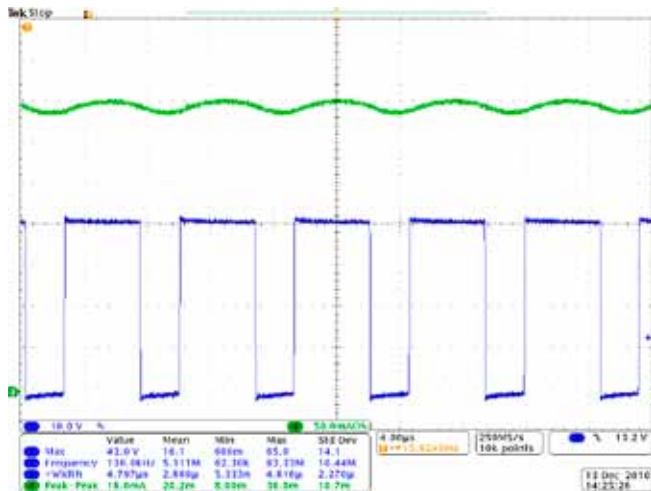

Fig.3: 40V Input

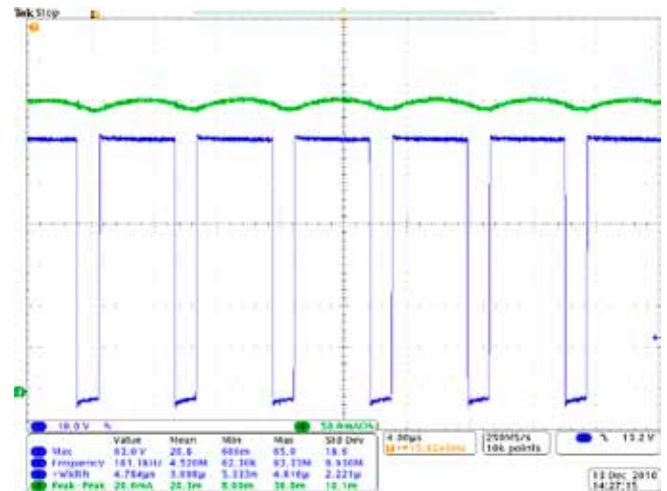

Fig.4: 60V Input

Ch1 (Blue) : Drain-Source Voltage (10V/div)
 Ch4 (Green) : Output LED Current (50mA/div)
 Time Scale : 4μs/div

PWM Dimming Operation:

PWM dimming operation at 4xLED in series with an external TTL square wave signal is shown in Figs.5 - 7. Fig.5 shows the overall operation of the circuit with PWM dimming input and Fig.6 and 7 show the rise and fall times of the LED current during PWM dimming.

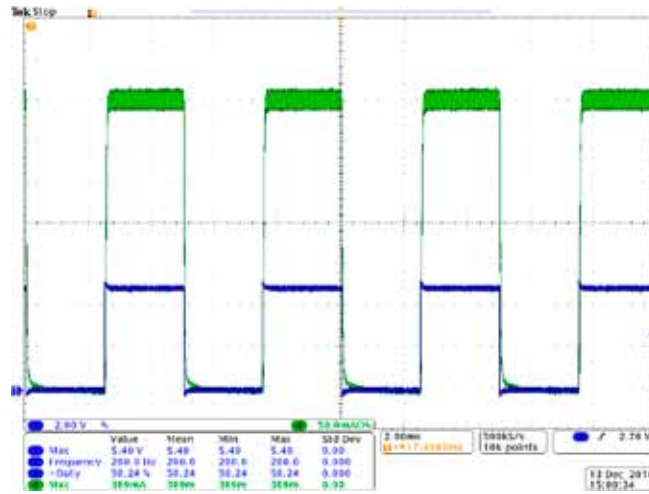

Fig.5: PWM Dimming at 24V

Ch1 (Blue) : Drain-Source Voltage (2V/div)
 Ch4 (Green) : Output LED Current (50mA/div)
 Time Scale : 2ms/div

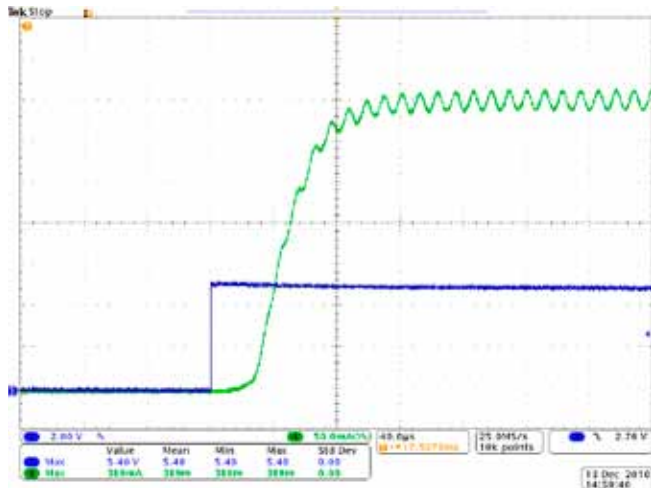

Fig.6: PWM Dimming at 24V – Rise Time

Ch1 (Blue) : Drain-Source Voltage (2V/div)
 Ch4 (Green) : Output LED Current (50mA/div)
 Time Scale : 2µs/div

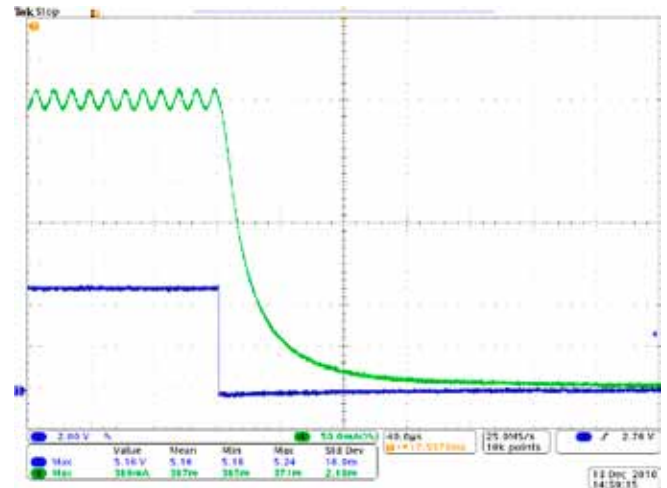

Fig.7: PWM Dimming at 24V – Fall Time

Bill of Materials

Item#	Qty	Ref Des	Description	Package	Manufacturer	Manufacturer's Part Number
1	1	C1	1 μ F 16V X7R ceramic chip capacitor	SMD 0805	Murata	GRM21BR71C105KA88L
2	1	C2	4.7 μ F 25V X7R ceramic chip capacitor	SMD 1206	Murata	GRM31CR71E475KA88L
3	1	C3	1 μ F 100V X7R ceramic chip capacitor	SMD 1210	Murata	GRM32CR72A105KA88L
4	1	C4	47 μ F 100V 105deg.C electrolytic capacitor	SMT	Panasonic	EEVFK2A470Q
5	1	D1	100V 1A schottky rectifier	SMA	Diodes Inc	B1100-13-F
6	2	J1, J2	2 position 5.08mm pitch vertical header	Thru-hole	Molex	10-08-5021
7	1	J3	3 position 2.54mm pitch vertical header	Thru-hole	Molex	22-03-2031
8	1	L1	330 μ H 0.39A 0.45A sat inductor	SMT	Würth Elektronik	744 777 233
9	1	R1	0R68 1/4W 1% chip resistor	SMD 1206	-	-
10	1	R2	1K0 1/8W 1% chip resistor	SMD 0805	-	-
11	1	R4	52K3 1/8W 1% chip resistor	SMD 0805	-	-
12	1	U1	Universal LED Driver	MSOP-8	Supertex	HV9967BMG-G

Supertex inc. does not recommend the use of its products in life support applications, and will not knowingly sell them for use in such applications unless it receives an adequate "product liability indemnification insurance agreement." **Supertex inc.** does not assume responsibility for use of devices described, and limits its liability to the replacement of the devices determined defective due to workmanship. No responsibility is assumed for possible omissions and inaccuracies. Circuitry and specifications are subject to change without notice. For the latest product specifications refer to the **Supertex inc.** (website: <http://www.supertex.com>)