

High gain low voltage PNP power transistor

Features

- Very low collector to emitter saturation voltage
- DC current gain > 100 (h_{FE})
- 3 A continuous collector current (I_C)

Applications

- Power management in portable equipments
- Switching regulator in battery charger applications

Description

The device is manufactured in low voltage PNP Planar Technology with "Base Island" layout. The resulting Transistor shows exceptional high gain performance coupled with very low saturation voltage.

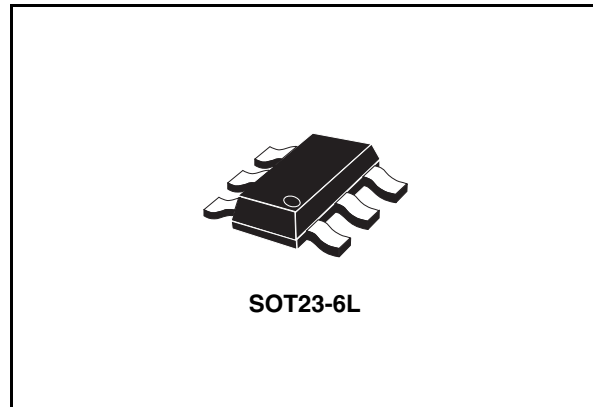

Figure 1. Internal schematic diagram

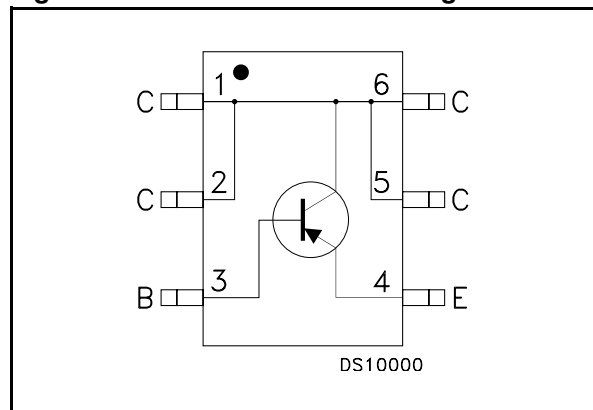

Table 1. Device summary

Order code	Marking	Package	Packaging
STT818B	818B	SOT23-6L	Tape & reel

Contents

1	Electrical ratings	3
2	Electrical characteristics	4
	2.1 Electrical characteristics (curves)	5
3	Package mechanical data	7
4	Revision history	9

1 Electrical ratings

Table 2. Absolute maximum rating

Symbol	Parameter	Value	Unit
V_{CBO}	Collector-base voltage ($I_E = 0$)	-30	V
V_{CEO}	Collector-emitter voltage ($I_B = 0$)	-30	V
V_{EBO}	Emitter-base voltage ($I_C = 0$)	-5	V
I_C	Collector current	-3	A
I_{CM}	Collector peak current ($t_P < 5\text{ms}$)	-6	A
I_B	Base current	-0.2	A
I_{BM}	Base peak current ($t_P < 5\text{ms}$)	-0.5	A
P_{tot}	Total dissipation at $T_{amb} = 25^\circ\text{C}$	1.2	W
T_{stg}	Storage temperature	-65 to 150	$^\circ\text{C}$
T_J	Max. operating junction temperature	150	$^\circ\text{C}$

Table 3. Thermal data

Symbol	Parameter	Value	Unit
$R_{thj-amb}$ (1)	Thermal resistance junction-ambient max	104.2	$^\circ\text{C/W}$

1. Package mounted on FR4 pcb 25mm x 25mm.

2 Electrical characteristics

($T_{\text{case}} = 25^{\circ}\text{C}$ unless otherwise specified)

Table 4. Electrical characteristics

Symbol	Parameter	Test conditions	Min.	Typ.	Max.	Unit
I_{CBO}	Collector cut-off current ($I_{\text{E}} = 0$)	$V_{\text{CB}} = -30 \text{ V}$ $V_{\text{CB}} = -30 \text{ V}$ $T_{\text{C}} = 125^{\circ}\text{C}$			-0.1 -20	μA μA
I_{EBO}	Collector-cut-off current ($I_{\text{C}} = 0$)	$V_{\text{EB}} = -5 \text{ V}$			-0.1	μA
$V_{(\text{BR})\text{CEO}}^{(1)}$	Collector-emitter breakdown voltage ($I_{\text{B}} = 0$)	$I_{\text{C}} = -10 \text{ mA}$	-30			V
$V_{\text{CE}(\text{sat})}^{(1)}$	Collector-emitter saturation voltage	$I_{\text{C}} = -0.5 \text{ A}$ $I_{\text{B}} = -5 \text{ mA}$ $I_{\text{C}} = -1.2 \text{ A}$ $I_{\text{B}} = -12 \text{ mA}$ $I_{\text{C}} = -2 \text{ A}$ $I_{\text{B}} = -20 \text{ mA}$		-0.075 -0.21	-0.15 -0.3 -0.5	V V V
$V_{\text{BE}(\text{sat})}^{(1)}$	Base-emitter saturation voltage	$I_{\text{C}} = -0.5 \text{ A}$ $I_{\text{B}} = -5 \text{ mA}$ $I_{\text{C}} = -1.2 \text{ A}$ $I_{\text{B}} = -12 \text{ mA}$ $I_{\text{C}} = -2 \text{ A}$ $I_{\text{B}} = -20 \text{ mA}$		-0.74	-1.1 -1.1 -1.2	V V V
$h_{\text{FE}}^{(1)}$	DC current gain	$I_{\text{C}} = -0.5 \text{ A}$ $V_{\text{CE}} = -1 \text{ V}$ $I_{\text{C}} = -2.5 \text{ A}$ $V_{\text{CE}} = -3 \text{ V}$	100 100			
$V_{\text{BE}(\text{ON})}^{(1)}$	Base-emitter voltage	$I_{\text{C}} = -0.5 \text{ A}$ $V_{\text{CE}} = -2 \text{ V}$		-0.71	-1.1	V

1. Pulse duration = 300 μs , duty cycle 1.5 %.

2.1 Electrical characteristics (curves)

Figure 2. Safe operating area

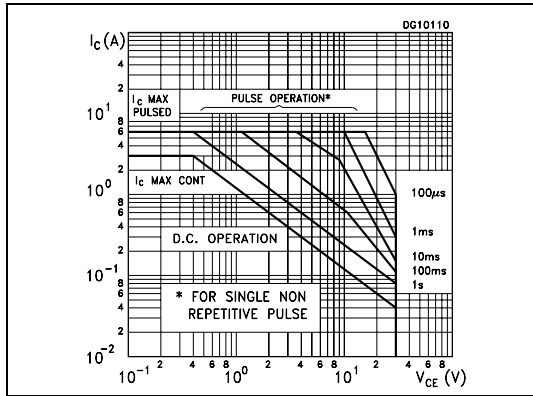

Figure 3. Derating curve

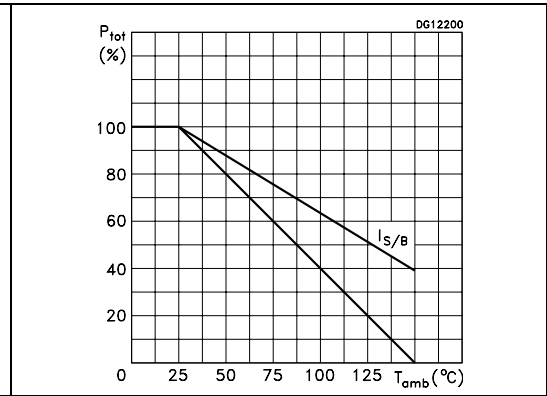

Figure 4. DC Current Gain

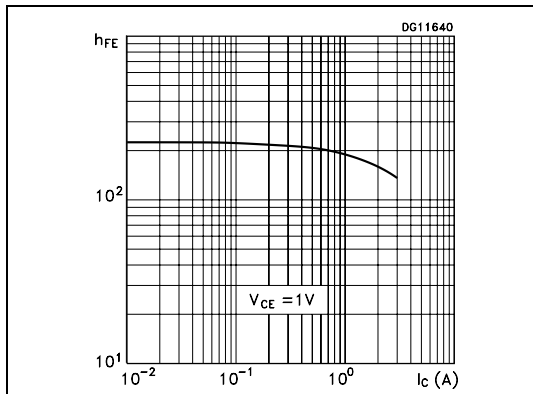

Figure 5. DC Current Gain

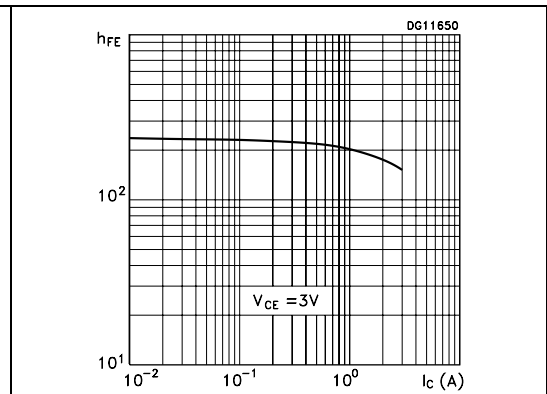

Figure 6. Collector-emitter saturation voltage

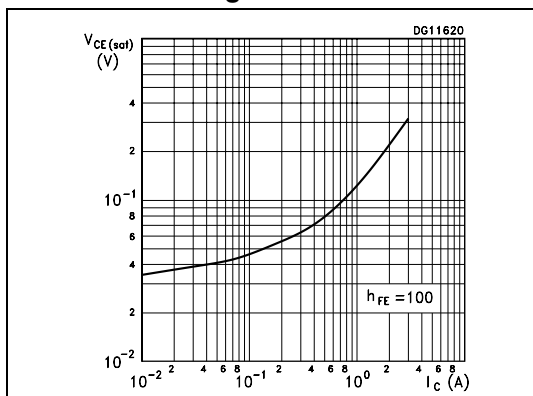

Figure 7. Base-emitter saturation voltage

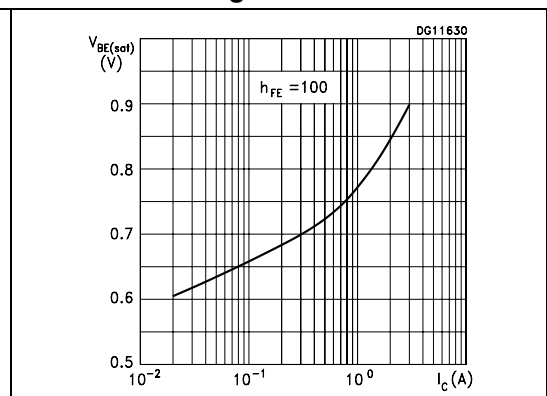

Figure 8. Switching times resistive load

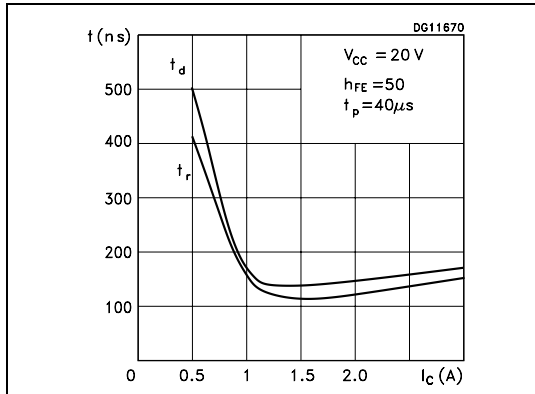
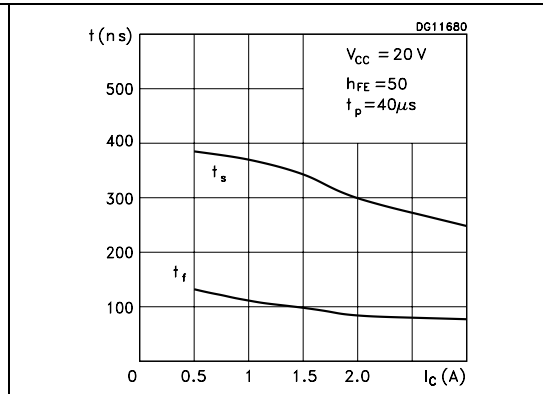

Figure 9. Switching times resistive load



3 Package mechanical data

In order to meet environmental requirements, ST offers these devices in ECOPACK® packages. These packages have a Lead-free second level interconnect. The category of second level interconnect is marked on the package and on the inner box label, in compliance with JEDEC Standard JESD97. The maximum ratings related to soldering conditions are also marked on the inner box label. ECOPACK is an ST trademark. ECOPACK specifications are available at: www.st.com

SOT23-6L MECHANICAL DATA

DIM.	mm			mils		
	MIN.	TYP.	MAX.	MIN.	TYP.	MAX.
A	0.90		1.45	0.035		0.057
A1	0.00		0.15	0.000		0.006
A2	0.90		1.30	0.035		0.051
b	0.25		0.50	0.010		0.020
C	0.09		0.20	0.004		0.008
D	2.80		3.10	0.110		0.122
E	2.60		3.00	0.102		0.118
E1	1.50		1.75	0.059		0.069
L	0.35		0.55	0.014		0.022
e		0.95			0.037	
e1		1.90			0.075	

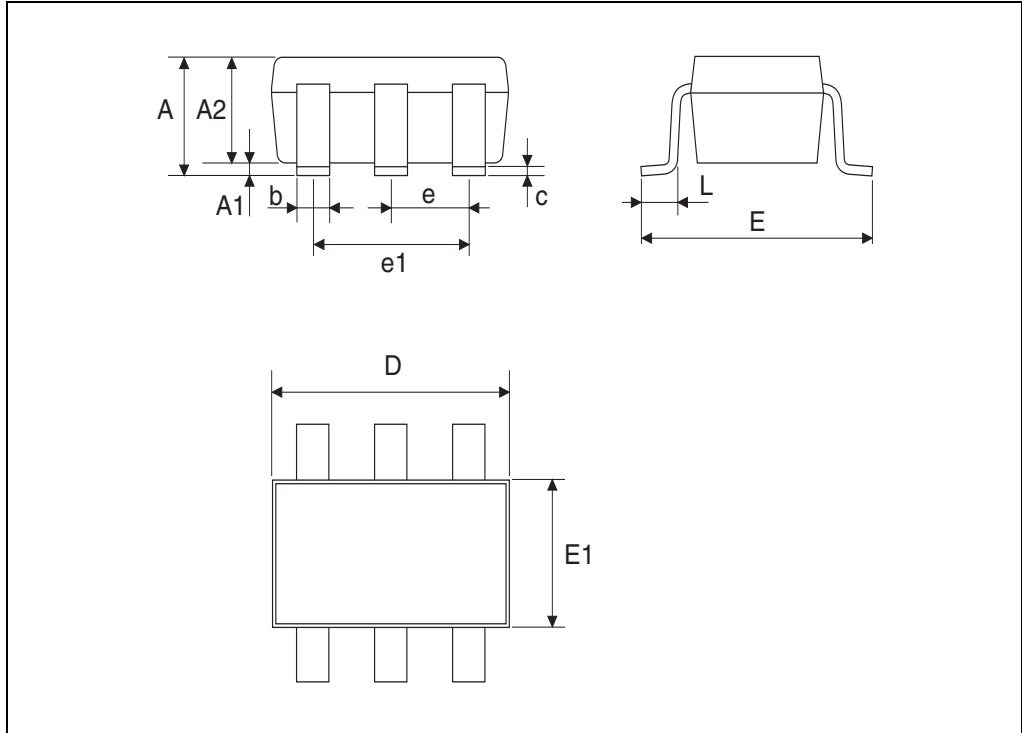

4 Revision history

Table 5. Document revision history

Date	Revision	Changes
12-Jul-2002	4	No content change; the document has been reformatted
08-Aug-2007	5	Updated Figure 3

Please Read Carefully:

Information in this document is provided solely in connection with ST products. STMicroelectronics NV and its subsidiaries ("ST") reserve the right to make changes, corrections, modifications or improvements, to this document, and the products and services described herein at any time, without notice.

All ST products are sold pursuant to ST's terms and conditions of sale.

Purchasers are solely responsible for the choice, selection and use of the ST products and services described herein, and ST assumes no liability whatsoever relating to the choice, selection or use of the ST products and services described herein.

No license, express or implied, by estoppel or otherwise, to any intellectual property rights is granted under this document. If any part of this document refers to any third party products or services it shall not be deemed a license grant by ST for the use of such third party products or services, or any intellectual property contained therein or considered as a warranty covering the use in any manner whatsoever of such third party products or services or any intellectual property contained therein.

UNLESS OTHERWISE SET FORTH IN ST'S TERMS AND CONDITIONS OF SALE ST DISCLAIMS ANY EXPRESS OR IMPLIED WARRANTY WITH RESPECT TO THE USE AND/OR SALE OF ST PRODUCTS INCLUDING WITHOUT LIMITATION IMPLIED WARRANTIES OF MERCHANTABILITY, FITNESS FOR A PARTICULAR PURPOSE (AND THEIR EQUIVALENTS UNDER THE LAWS OF ANY JURISDICTION), OR INFRINGEMENT OF ANY PATENT, COPYRIGHT OR OTHER INTELLECTUAL PROPERTY RIGHT.

UNLESS EXPRESSLY APPROVED IN WRITING BY AN AUTHORIZED REPRESENTATIVE OF ST, ST PRODUCTS ARE NOT RECOMMENDED, AUTHORIZED OR WARRANTED FOR USE IN MILITARY, AIR CRAFT, SPACE, LIFE SAVING, OR LIFE SUSTAINING APPLICATIONS, NOR IN PRODUCTS OR SYSTEMS, WHERE FAILURE OR MALFUNCTION MAY RESULT IN PERSONAL INJURY, DEATH, OR SEVERE PROPERTY OR ENVIRONMENTAL DAMAGE. ST PRODUCTS WHICH ARE NOT SPECIFIED AS "AUTOMOTIVE GRADE" MAY ONLY BE USED IN AUTOMOTIVE APPLICATIONS AT USER'S OWN RISK.

Resale of ST products with provisions different from the statements and/or technical features set forth in this document shall immediately void any warranty granted by ST for the ST product or service described herein and shall not create or extend in any manner whatsoever, any liability of ST.

ST and the ST logo are trademarks or registered trademarks of ST in various countries.

Information in this document supersedes and replaces all information previously supplied.

The ST logo is a registered trademark of STMicroelectronics. All other names are the property of their respective owners.

© 2007 STMicroelectronics - All rights reserved

STMicroelectronics group of companies

Australia - Belgium - Brazil - Canada - China - Czech Republic - Finland - France - Germany - Hong Kong - India - Israel - Italy - Japan - Malaysia - Malta - Morocco - Singapore - Spain - Sweden - Switzerland - United Kingdom - United States of America

www.st.com