

| P | LTR | DESCRIPTION | DATE | DWN | APVD |
|---|-----|---|-----------|-----|------|
| A | | Création - diffusion 331623 | 01MAR2016 | MB | MV |
| B | | Change dimension and tolerances Diffusion N°331764 | 01JUN2016 | MB | MV |
| C | | Change reference item 1 & 2 + + Add product & application spec + Add item 3 - Diffusion 331914 | 19SEP2016 | EL | MV |

1 () : cotes pour information / dimensions for information
 () : cotes de controle / inspection dimensions

2  Instructions de mise en oeuvre à appliquer par le client
 Customer instructions to be applied by the customer

3 Standards :
 AAR S-512, APTA RP-E-019-99

4 Catalog number : 27P-KITCON-24S12-3S10

5 Crimping tools :
 DANIELS CRIMPING HAND CRIMPER HX4 WITH Y543 DIES
 or
 DANIELS PNEUMATIC CRIMPER HX23 WITH Y543 DIES

6 Cable sheath stripping length = ,54

7 Contacts packed in a labeled bag :
 27P-KITCON-24S12-3S10





 Groove on contact AWG10 only

 Ref. YS-UC-212601A-AA1A (item2) is a KIT with 3 contacts

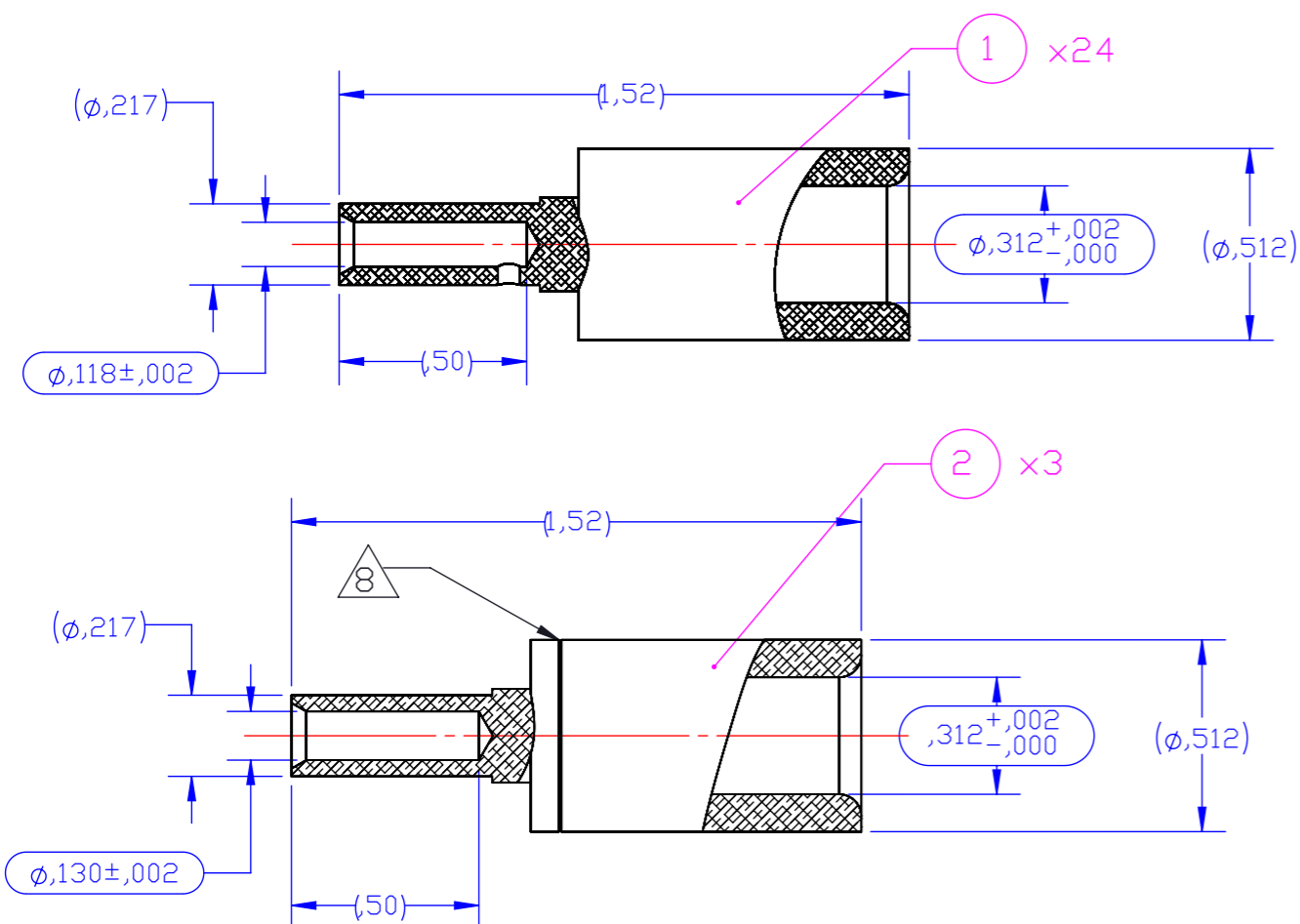
 Ref. YS-UC-212602A-AA1A (item1) is a KIT with 24 contacts

11 Packaging Specification 107-157003







| | | | | | | | | | |
|--|-----------------------------|-----------------------------|----------------------|-------------------------|------------|-----------------------------|--|-------------|---|
| - | - | - | Plastique Plastic | 0,2 | 1 | Y0000000000-EMB031 | Sachet plastique Plastic bag | 3 |  |
|  | Argenture Silver plating | FMME 1001 | Laiton Brass | 58.74 | 1 | YS-UC-212601A-AA1A | KIT de 3 contacts femelle AWG 10 KIT with 3 female contacts 10 AWG | 2 |  |
|  | Argenture Silver plating | FMME 1001 | Laiton Brass | 473.57 | 1 | YS-UC-212602A-AA1A | KIT de 24 contacts femelle AWG 12 et 14 KIT with 24 female contacts 12 and 14 AWG | 1 |  |
| Observations Remarks | Protection Plating | Fiche matière Data sheet | Matière Material | Masse (g) Weight (g) | Nbr Qty | Codification Part number | Désignation Designation | REP Item | |

Référence commerciale / commerciale reference : 27P-KITCON-24S12-3S10

YS-UC-212398A-0000

PART NO

| | | | | | |
|---|--|--|--------------|--|---|
| THIS DRAWING IS A CONTROLLED DOCUMENT. | | DWN M.BONNIN | 01MAR2016 |  TE Connectivity | |
| DIMENSIONS: inch | | CHK JF.GALIPAUD | 01MAR2016 | | |
| TOLERANCES UNLESS OTHERWISE SPECIFIED: | | APVD M.VIMARD | 01MAR2016 | | |
|  | | PRODUCT SPEC 108-157001  | | NAME S/A female contacts kit for plug | |
| MATERIAL BRASS | | FINISH SILVER PLATING | | APPLICATION SPEC 408-157000-2  | |
| | | WEIGHT 1.049 pound | | SIZE A3 | CAGE CODE DRAWING NO S1894-212398 |
| CUSTOMER DRAWING | | | SCALE 2:1 | SHEET 1 OF 1 | REV C |