

Ordering a market-ready enclosure® is made fast and affordable with our complete in-house capabilities. New Age provides machined openings to fit your PCB, pad printing for your graphics, custom enclosures, custom colors, final assembly, testing and fulfillment services to save you additional time and money. Ask your representative for a free quote today 805-595-1310.

## ***Fast and Affordable Customization***

**CNC Modifications  
Pad Printing  
Colored Resins  
EMI/RF Shielding  
Custom Enclosure  
Assembly & Testing**

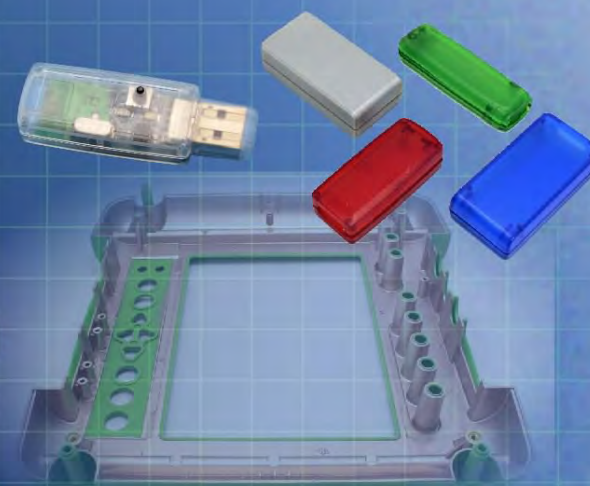

ISO quality  
off-the-shelf  
to market-ready®

# **NEW AGE ENCLOSURES**

[www.NewAgeEnclosures.com](http://www.NewAgeEnclosures.com)

4330 Santa Fe Road • San Luis Obispo, CA 93401 • T 805.595.1310 • F 805.595.1024

**NOTES: UNLESS OTHERWISE SPECIFIED**

1. CORNERS DRAWN SHARP TO BE R.005 MAXIMUM.
2. EXTERIOR SURFACE TEXTURE TO BE LIGHT EDM FINISH. EQUIVELANT TO MT-11010.
3. INTERIOR SURFACE TEXTURE: NONE
4. ALL INSIDE RADII .010R. UNLESS OTHERWISE SPECIFIED.
5. ALL EXTERNAL DIMENSIONS AFFECTED BY THE DRAFT APPLY AT THE LARGE END OF THE FEATURE, AND ALL INTERNAL FEATURES AFFECTED BY THE DRAFT APPLY AT THE SMALL END OF THE FEATURE UNLESS OTHERWISE SPECIFIED.
6. 1 DEGREES DRAFT IN THE DIRECTION OF PULL IS PERMISSIBLE UNLESS OTHERWISE SPECIFIED.
7. THIS ENCLOSURE IS A PRESS FIT ASSEMBLY. FOR PERMANENT CLOSURE: A DROP ADHESIVE OR ULTRASONIC WELDING IS REQUIRED.
8. MATERIAL / COLOR: ABS PLASTIC IS STANDARD IN BLACK OR WHITE. CUSTOM MATERIALS AND COLORS ARE AVAILABLE UPON REQUEST FOR QUOTE.
9. PCB SIZES ARE RECOMMENDATIONS ONLY. FINAL SIZES AND VERIFICATION OF IT'S FIT ARE THE SOLE RESPONSIBILITY OF EACH OWNER.
10. THE GATE REMNANT FOR THIS ENCLOSURE IS LOCATED IN THIS POSITION TO MINIMIZE ANY COSMETIC IMPACT. IT IS HOWEVER VISIBLE AND VARIES IN SIZE / SHAPE. IT IS EASILY REMOVED WITH CLIPPERS. IF YOU WOULD LIKE NEW AGE TO CLIP THIS FOR YOU, PLEASE ASK YOUR SALES REPRESENTIVE FOR A FREE QUOTE.

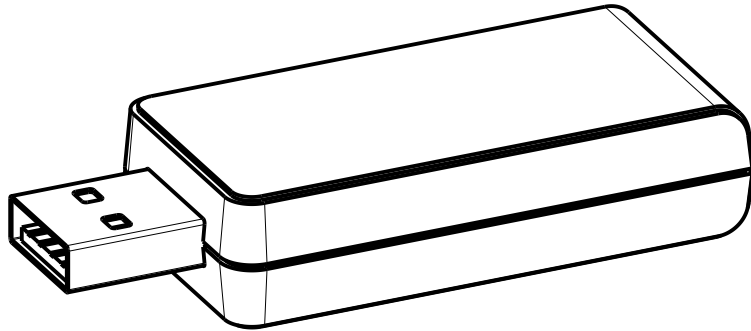

SCALE 1.500

R E V I S I O N					
REV.	DRAWN BY	ECO No	DESCRIPTION	DATE	APPROVED
1	M BOYER		PRELIMINARY RELEASE	21-May-07	D.C.
2	M BOYER		ADD WIDE PCB CONFIGURATION	06-Jun-07	D.C.
3	M BOYER		MOVE PCB POSTS OUTWARD .03 PER SIDE	30-Jul-07	D.C.
4	M BOYER		UPDATE TO AS BUILT	12-Oct-07	D.C.
5	M BOYER	0208	UPDATE FORMAT AND RELEASE	04-Apr-08	D.C.
5.1	M BOYER	0710	UPDATE FORMAT	30-Mar-10	D.C.
5.2	M BOYER	0810	ADD NOTE 10	08-Apr-10	D.C.
6.0	M BOYER	2910	UPDATE BOARD THICKNESS INFORMATION	16-Aug-10	D.C.
6.1	M BOYER	3010	DOCUMENT CHANGE	24-Aug-10	D.C.
6.2	M BOYER	2711	CHANGE ASSEMBLY DIMENSIONS TO "PRESS FIT"	21-Oct-11	D.C.
7.0	M BOYER	1913	INCLUDE .062" PCB OPTION	09-Apr-13	D.C.
7.1	R CRUZ	8713	REMOVE .062" COVER OPTION	18-Dec-13	

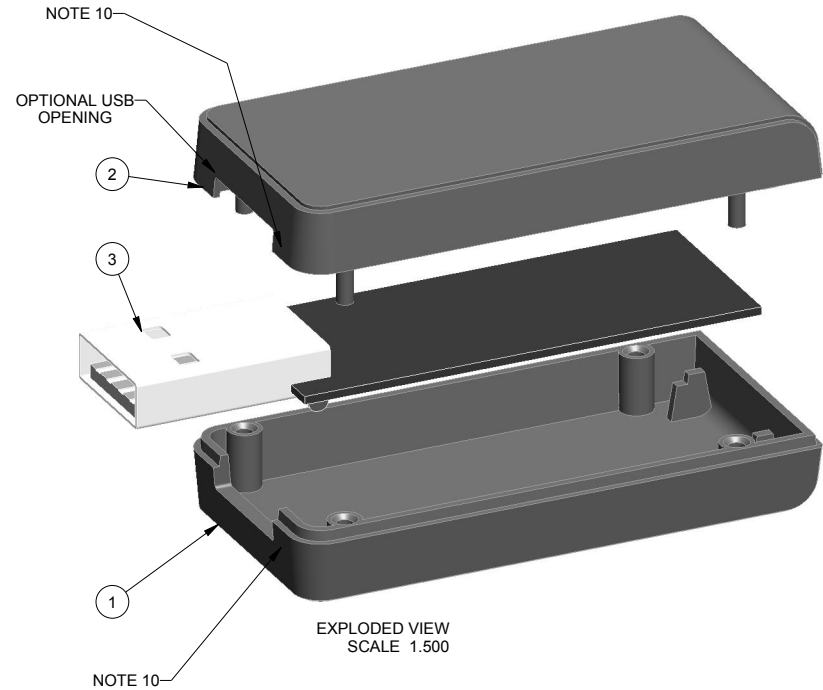

EXPLODED VIEW  
SCALE 1.500

P201005(x) CONFIGURATIONS				
	-S	-U	-62S	-62U
201005 COVER	1		1	
201005 COVER w/ USB OPENING		1		1
201005 BASE	1			
201005 BASE (.062" PCB)			1	
201005 BASE w/ USB OPENING		1		
201005 BASE (.062" PCB) w/ USB OPENING				1

ITEM	FILE NAME	DESCRIPTION	MATERIAL	COLOR	QTY.
3	201005_PCB	201005 PCB - REFERENCE	.031" THICK	CUSTOMER SUPPLIED	1
2	201005_COVER	201005U COVER - STANDARD	ABS	BLACK or WHITE	1
1	201005_BASE	201005U BASE - STANDARD	ABS	BLACK or WHITE	1

**BILL OF MATERIALS**

THIRD ANGLE PROJECTION  DO NOT SCALE DRAWING	TOLERANCES: UNLESS OTHERWISE SPECIFIED DIMENSIONS ARE IN U.S. INCHES. X.XX = .015 X.XXXX = .001 X.XXX = .010 X.X" = 1°	<b>NEW AGE ENCLOSURES</b> 4330 Santa Fe Road San Luis Obispo, CA. 93401 ph. (805) 595-1310 fax (805) 595-1024 <a href="http://www.newageenclosures.com">www.newageenclosures.com</a>				
	NEW AGE ENCLOSURES Customer's Part No: 201005					
APPROVAL BY DATE CHECK _____ ENG. _____ SCALE AS NOTED	DRAWN BY M BOYER	DATE 21-May-07	SIZE A	DRAWING NAME 201005_R7_1	SHEET 1 OF 6	REV.DOC 7.1

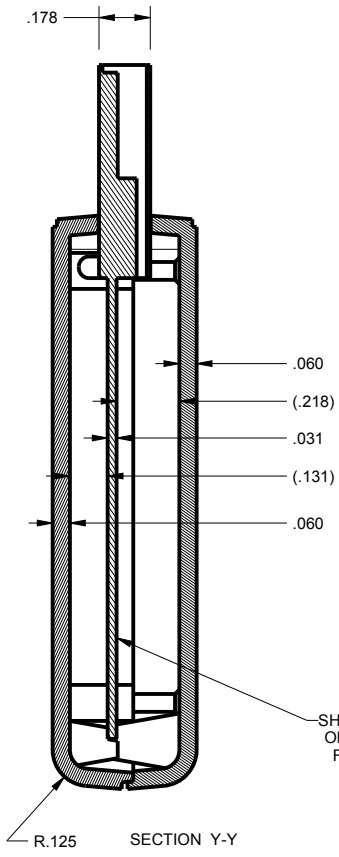
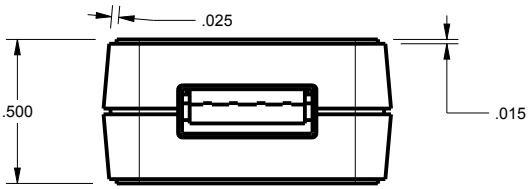

SHOWN WITH .031" PCB  
ORDER "62" VERSION  
FOR OPTIONAL PCB  
THICKNESS

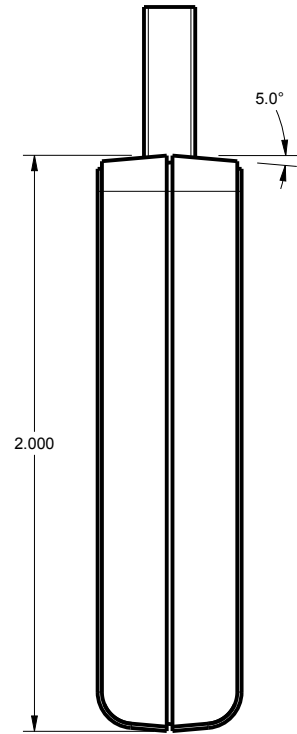
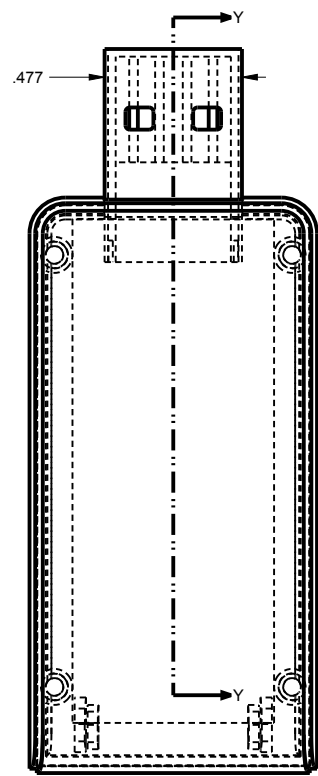

SCALE 1.500

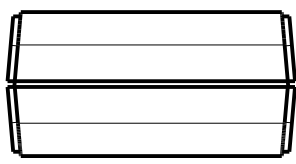

TOLERANCES: UNLESS OTHERWISE SPECIFIED  
DIMENSIONS ARE IN U.S. INCHES.  
X.XX = .015 X.XXXX = .001  
X.XXX = .010 X.X° = 1°

NEW AGE ENCLOSURES  
Customer's Part No: 201005

APPROVAL	BY	DATE
CHECK		
ENG.		
SCALE	AS NOTED	

DRAWN BY  
M BOYER 21-May-07

**NEW AGE ENCLOSURES**  
4330 Santa Fe Road San Luis Obispo, CA. 93401  
ph. (805) 595-1310 fax (805) 595-1024  
[www.newageenclosures.com](http://www.newageenclosures.com)

**STANDARD - USB DEVICE  
PXX-201005X ASSEMBLY**

SIZE A	DRAWING NAME 201005_R7_1	SHEET 2 OF 6	REV.DOC 7.1
-----------	-----------------------------	-----------------	----------------

201005U COVER

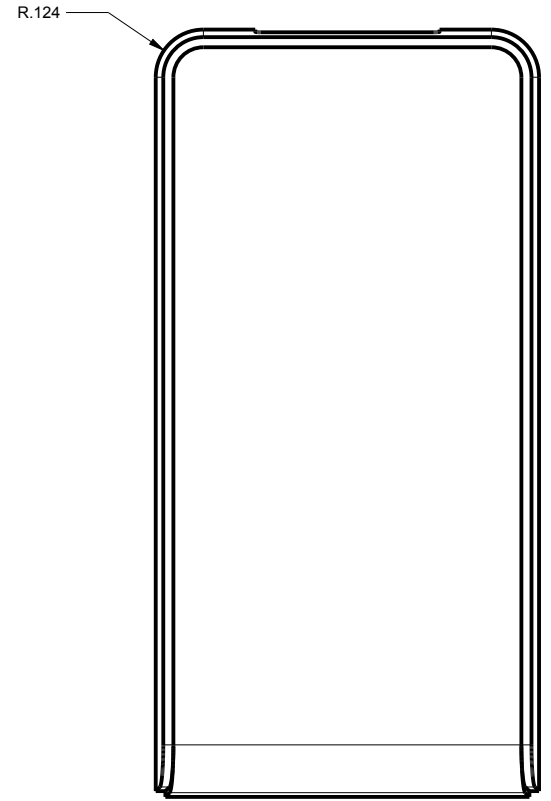
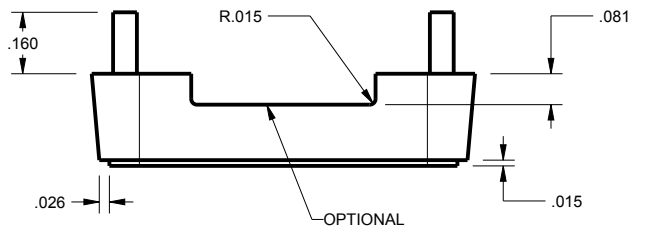

SCALE 2.000

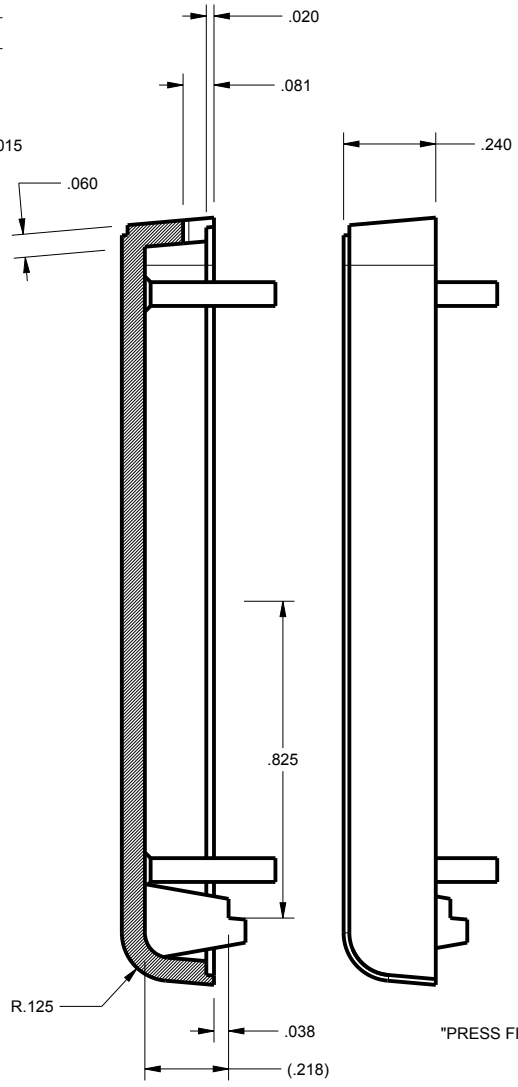

SECTION Y-Y

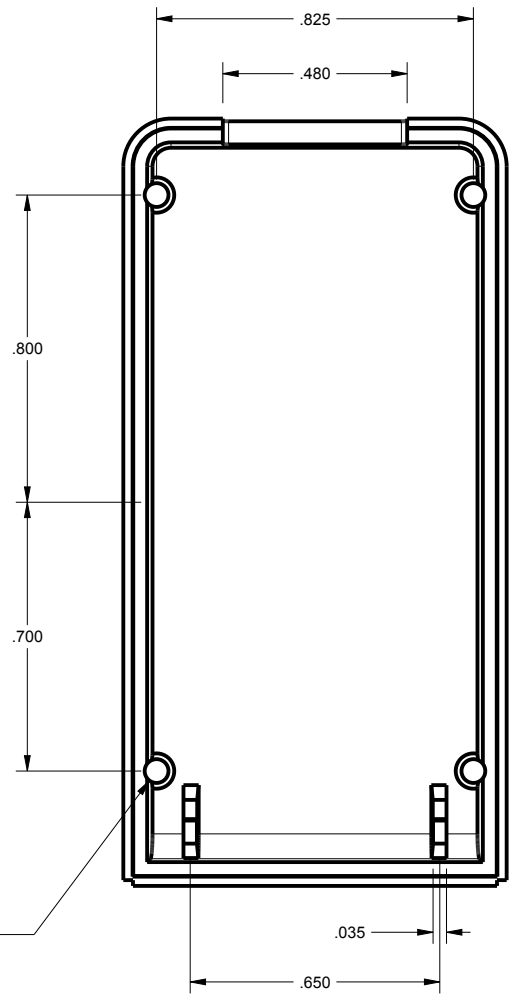
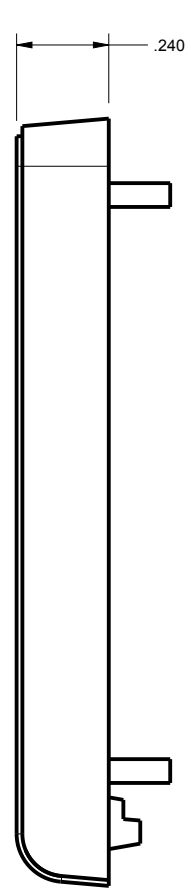

"PRESS FIT"

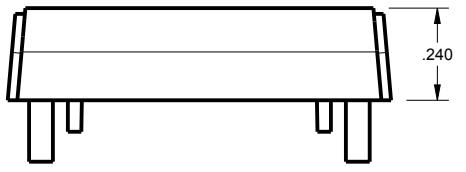

TOLERANCES: UNLESS OTHERWISE SPECIFIED DIMENSIONS ARE IN U.S. INCHES. X.XX = .015 X.XXXX = .001 X.XXX = .010 X.X° = 1°		<b>NEW AGE ENCLOSURES</b>	
NEW AGE ENCLOSURES		4330 Santa Fe Road San Luis Obispo, CA. 93401 ph. (805) 595-1310 fax (805) 595-1024 <a href="http://www.newageenclosures.com">www.newageenclosures.com</a>	
Customer's Part No: 201005			
APPROVAL	BY	DATE	
CHECK			
ENG.			
SCALE	AS NOTED		
DRAWN BY		SIZE	DRAWING NAME
M BOYER	21-May-07	A	201005_R7_1
SHEET	REV.DOC		
3 OF 6	7.1		

201005U BASE

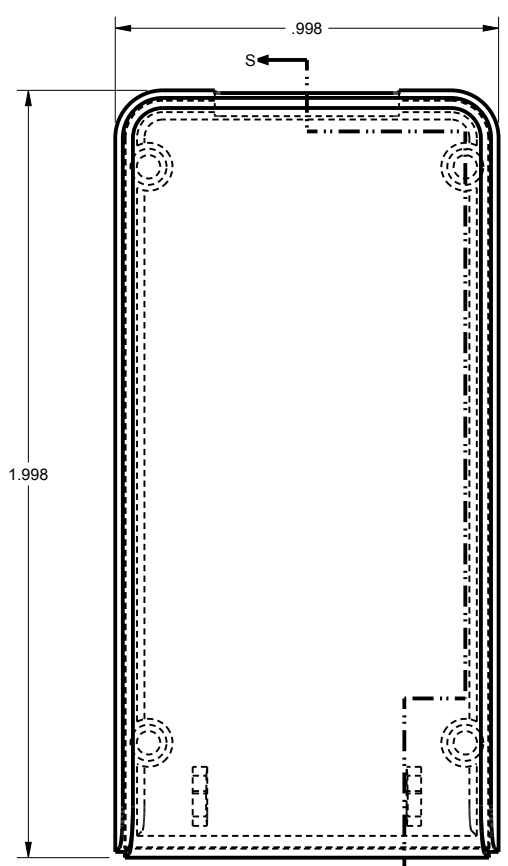
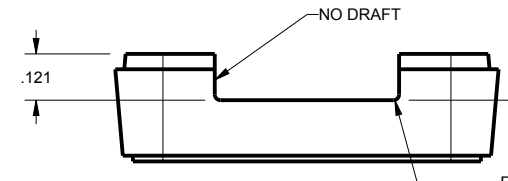

SCALE 2.000

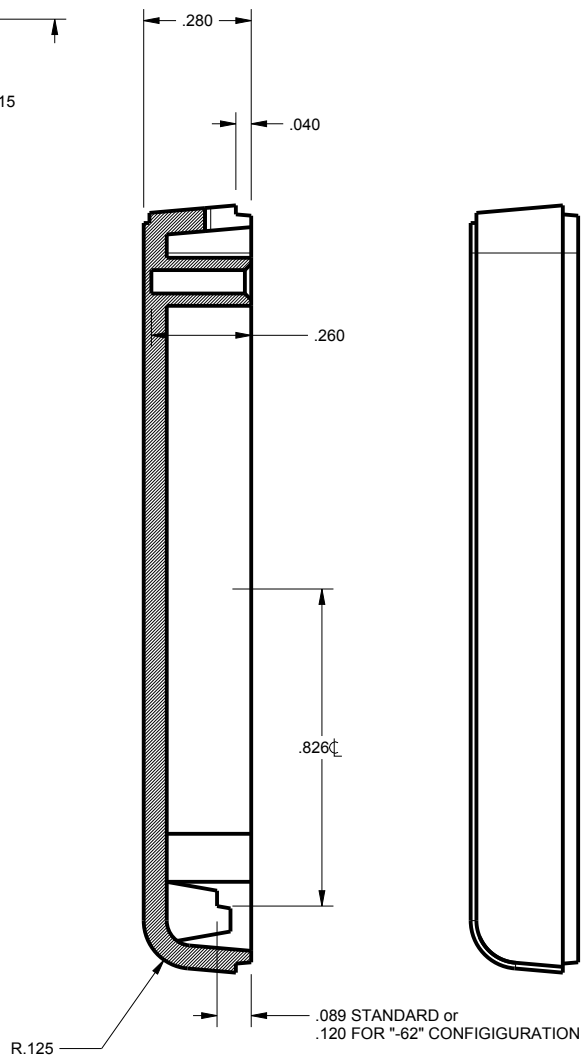
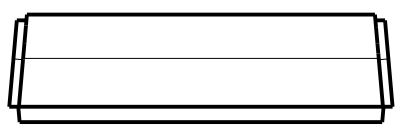

SECTION S-S

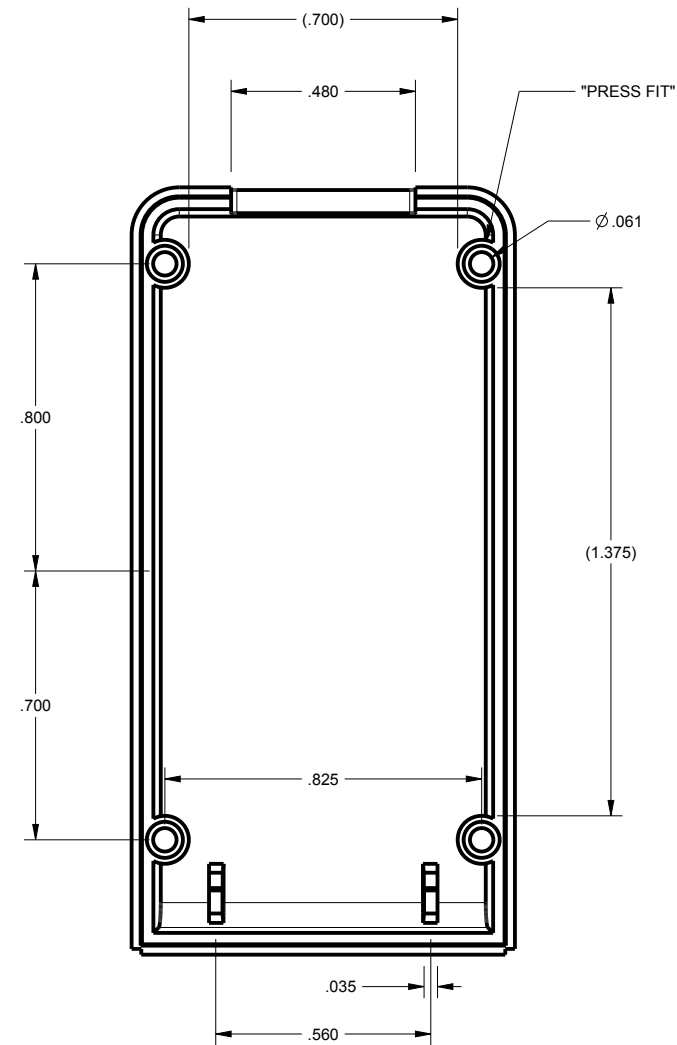

TOLERANCES: UNLESS OTHERWISE SPECIFIED  
DIMENSIONS ARE IN U.S. INCHES.  
X.XX = .015 X.XXXX = .001  
X.XXX = .010 X.X° = 1°

NEW AGE ENCLOSURES  
Customer's Part No: 201005

APPROVAL	BY	DATE
CHECK		
ENG.		
SCALE	AS NOTED	

DRAWN BY  
M BOYER 21-May-07

**NEW AGE ENCLOSURES**  
4330 Santa Fe Road San Luis Obispo, CA. 93401  
ph. (805) 595-1310 fax (805) 595-1024  
[www.newageenclosures.com](http://www.newageenclosures.com)

**STANDARD - USB DEVICE  
PXX-201005X ASSEMBLY**

SIZE A	DRAWING NAME 201005_R7_1	SHEET 4 OF 6	REV.DOC 7.1
-----------	-----------------------------	-----------------	----------------

# 201005 PCB - CUSTOMER SUPPLIED

PCB SIZES ARE RECOMMENDATIONS ONLY. FINAL SIZES AND VERIFICATION OF IT'S FIT ARE THE SOLE RESPONSIBILITY OF THE OEM.

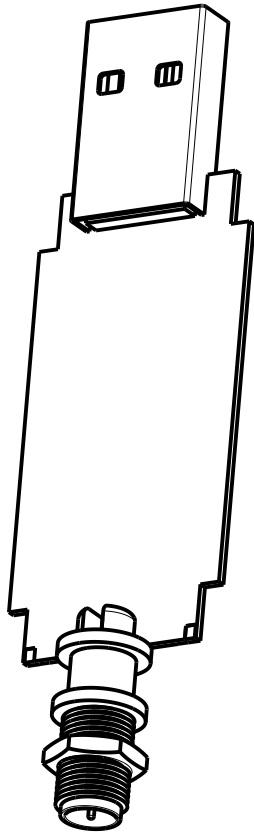

SCALE 1.500

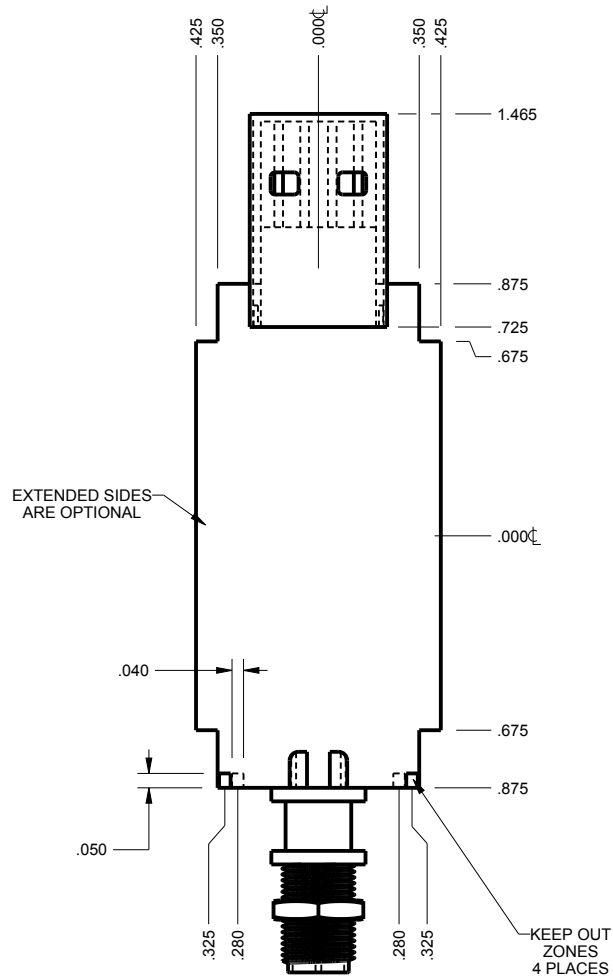

SCALE 1.500

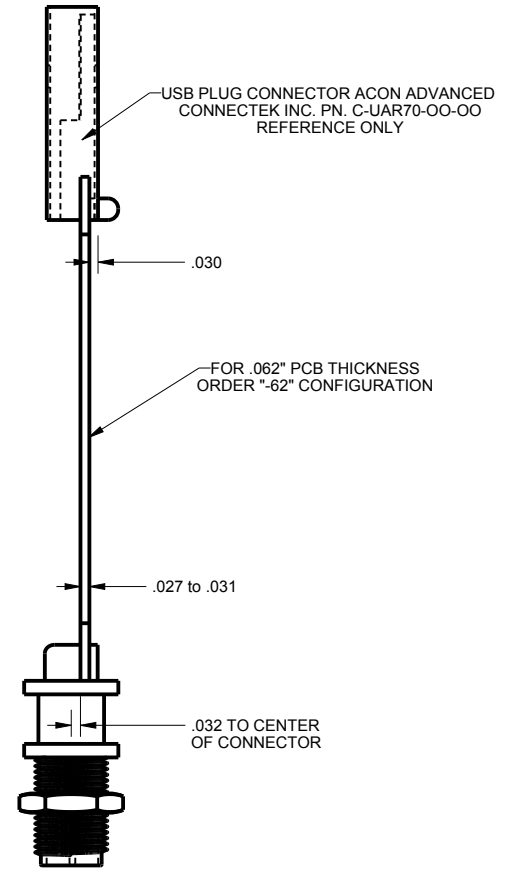

\*\* = RECOMMENDED BOARD THICKNESS IS .031" or .062" THICK, OPTIONS ARE AVAILABLE TO ALLOW OTHER THICKNESSES. ASK YOUR SALES REP FOR A QUOTE.

TOLERANCES: UNLESS OTHERWISE SPECIFIED DIMENSIONS ARE IN U.S. INCHES. X.XX = .015 X.XXXX = .001 X.XXX = .010 X.X° = 1°		<b>NEW AGE ENCLOSURES</b>	
NEW AGE ENCLOSURES		4330 Santa Fe Road San Luis Obispo, CA. 93401 ph. (805) 595-1310 fax (805) 595-1024 <a href="http://www.newageenclosures.com">www.newageenclosures.com</a>	
Customer's Part No: 201005			
APPROVAL	BY	DATE	
CHECK			
ENG.			
SCALE	AS NOTED		
DRAWN BY	21-May-07	SIZE	DRAWING NAME
M BOYER		A	201005_R7_1
		SHEET	REV.DOC
		5 OF 6	7.1

**NEW AGE ENCLOSURES**  
STANDARD - USB DEVICE PXX-201005X ASSEMBLY

## 2nd OPERATION DETAILS

New Age Enclosures DELIVERS YOUR ENCLOSURE MARKET-READY WITH IN-HOUSE  
CNC MACHINING, PAD PRINTING, ASSEMBLY, AND FULFILLMENT.  
ALL SURFACES AND AREAS ARE AVAILABLE FOR CNC ALTERATION BY New Age Enclosures  
CALL (805) 595-1310 FOR PRICING AND SCHEDULE.  
THE INSIDE RADIUS OF ANY MACHINED FEATURES SHOULD BE NO SMALLER THAN .031"

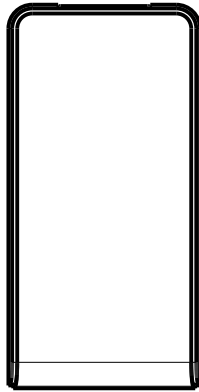
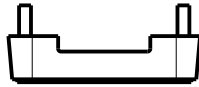

201005U COVER  
SCALE 1.000

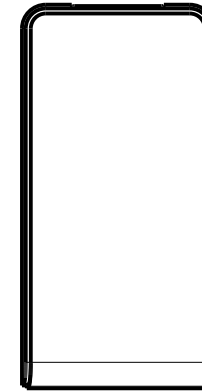
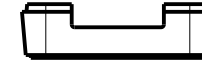
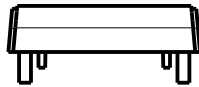
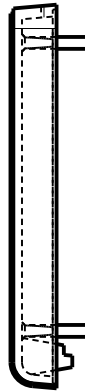

201005U BASE  
SCALE 1.000

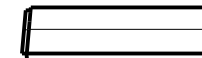

### PXX-201005U-XXX COVER - ABS, BLACK

STEP NO	DESCRIPTION	CUTTER	FIXTURE	ORIENTATION	PROGRAM
1	-	T2 = .062" EM	103	-	
2	-	T2 = .062" EM	103	-	

### PXX-201005U-XXX BASE - ABS, BLACK

STEP NO	DESCRIPTION	CUTTER	FIXTURE	ORIENTATION	PROGRAM
3	-	T2 = .062" EM	103	-	
4	-	T2 = .062" EM	103	-	

TOLERANCES: UNLESS OTHERWISE SPECIFIED  
DIMENSIONS ARE IN U.S. INCHES.  
X.XX = .015 X.XXXX = .001  
X.XXX = .010 X.X° = 1°

Customer's Part No: 201005

APPROVAL	BY	DATE
CHECK		
ENG.		
SCALE	AS NOTED	
DRAWN BY		
M BOYER		21-May-07

## NEW AGE ENCLOSURES

4330 Santa Fe Road San Luis Obispo, CA. 93401  
ph. (805) 595-1310 fax (805) 595-1024  
[www.newageenclosures.com](http://www.newageenclosures.com)

### STANDARD - USB DEVICE PXX-201005X ASSEMBLY

SIZE	DRAWING NAME	SHEET	REV. DOC
A	201005_R7_1	6 OF 6	7.1



# Mouser Electronics

Authorized Distributor

Click to View Pricing, Inventory, Delivery & Lifecycle Information:

## New Age Enclosures:

[P1A-201005U](#) [P3A-201005U](#) [P3A-201005S](#) [P1A-201005S](#) [P1A-20100562S](#) [P3A-20100562U](#) [P3A-20100562S](#)  
[P1A-20100562U](#)