

HLMP-EGxx, HLMP-ELxx

T-1³/₄ (5 mm) High Brightness AlInGaP Red and Amber LEDs

Description

The Broadcom[®] Precision Optical Performance AlInGaP LEDs provide superior light output for excellent readability in sunlight and are extremely reliable. AlInGaP LED technology provides extremely stable light output over long periods of time. Precision Optical Performance lamps utilize the aluminum indium gallium phosphide (AlInGaP) technology.

These LED lamps are untinted, T-1³/₄ packages incorporating second-generation optics, producing well-defined spatial radiation patterns at specific viewing cone angles.

These lamps are made with an advanced optical grade epoxy offering superior high temperature and high moisture resistance performance in outdoor signal and sign application. The maximum LED junction temperature limit of +130°C enables high temperature operation in bright sunlight conditions. The epoxy contains UV inhibitor to reduce the effects of long-term exposure to direct sunlight.

Benefits

- Superior performance for outdoor environment
- Suitable for auto-insertion onto PC board

Features

- Viewing angle: 15°, 23°, and 30°
- Well-defined spatial radiation pattern
- High brightness material
- Available in Red and Amber
 - Red AlInGaP 626 nm
 - Amber AlInGaP 590 nm
- Superior resistance to moisture
- Standoff and non-standoff package

Applications

- Traffic management:
 - Traffic signals
 - Pedestrian signals
 - Work zone warning lights
 - Variable message signs
- Solar power signs
- Commercial outdoor advertising
 - Signs
 - Marquee

Device Selection Guide

Part Number	Color and Dominant Wavelength, λ_d (nm) Typ ^a	Luminous Intensity, I_V (mcd) at 20 mA ^{b,c,d}		Standoff	Typical Viewing Angle (°) ^e
		Min	Max		
HLMP-EG1G-Y10DD	Red 626	9300	21000	No	15
HLMP-EG1H-Y10DD	Red 626	9300	21000	Yes	
HLMP-EL1G-130DD	Amber 590	16000	35000	No	
HLMP-EL1H-130DD	Amber 590	16000	35000	Yes	
HLMP-EG2G-XZ0DD	Red 626	7200	16000	No	23
HLMP-EG2H-XZ0DD	Red 626	7200	16000	Yes	
HLMP-EL2G-XZKDD	Amber 590	7200	16000	No	
HLMP-EL2H-XZKDD	Amber 590	7200	16000	Yes	
HLMP-EG3G-VX0DD	Red 626	4200	9300	No	30
HLMP-EG3H-VX0DD	Red 626	4200	9300	Yes	
HLMP-EL3G-VX0DD	Amber 590	4200	9300	No	
HLMP-EL3H-VX0DD	Amber 590	4200	9300	Yes	

- The dominant wavelength, λ_d , is derived from the CIE Chromaticity Diagram and represents the color of the lamp.
- The luminous intensity, I_V , is measured on the mechanical axis of the lamp package, and it is tested with pulsing condition.
- The optical axis is closely aligned with the package mechanical axis.
- Tolerance for each bin limit is $\pm 15\%$.
- $\theta_{1/2}$ is the off-axis angle where the luminous intensity is half the on-axis intensity.

Absolute Maximum Ratings ($T_J = 25^\circ\text{C}$)

Parameter	Red/ Amber	Unit
DC Forward Current ^a	50	mA
Peak Forward Current ^b	100	mA
Power Dissipation	120	mW
LED Junction Temperature	130	°C
Operating Temperature Range	-40 to +100	°C
Storage Temperature Range	-40 to +100	°C

- Derate linearly as shown in [Figure 6](#).
- Duty Factor 30%, frequency 1 kHz.

Electrical/Optical Characteristics (T_J = 25°C)

Parameter	Symbol	Min.	Typ.	Max.	Unit	Test Conditions
Forward Voltage Red and Amber	V _F	1.8	2.1	2.4	V	I _F = 20 mA
Reverse Voltage ^a Red and Amber	V _R	5	—	—	V	I _R = 100 μA
Dominant Wavelength ^b Red Amber	λ _d	618.0 584.5	626.0 590.0	630.0 594.5	nm	I _F = 20 mA
Peak Wavelength Red Amber	λ _{PEAK}	— —	634 594	— —	nm	Peak of Wavelength of Spectral Distribution at I _F = 20 mA
Thermal Resistance	Rθ _{J-PIN}	—	240	—	°C/W	LED junction to pin
Luminous Efficacy ^c Red Amber	η _v	— —	190 490	— —	lm/W	Emitted Luminous Power/ Emitted Radiant Power
Thermal Coefficient of λ _d Red Amber		— —	0.05 0.09	— —	nm/°C	I _F = 20 mA; +25° C ≤ T _J ≤ +100° C

- a. Indicates product final testing condition; long-term reverse bias is not recommended.
- b. The dominant wavelength is derived from the Chromaticity Diagram and represents the color of the lamp.
- c. The radiant intensity, I_e in watts per steradian, can be found from the equation I_e = I_v/η_v, where I_v is the luminous intensity in candela and η_v is the luminous efficacy in lumens/watt.

Part Numbering System

H L M P -

x ₁	x ₂	x ₃	x ₄
----------------	----------------	----------------	----------------

 -

x ₅	x ₆	x ₇	x ₈	x ₉
----------------	----------------	----------------	----------------	----------------

Code	Description	Option	
x ₁	Package Type	E	5-mm Standard Round AlInGaP
x ₂	Color	G	Red
		L	Amber
x ₃ x ₄	Viewing Angle and Lead Standoffs	1G	15° without lead standoffs
		1H	15° with lead standoffs
		2G	23° without lead standoffs
		2H	23° with lead standoffs
		3G	30° without lead standoffs
		3H	30° with lead standoffs
x ₅	Minimum Intensity Bin	Refer to Device Selection Guide .	
x ₆	Maximum Intensity Bin		
x ₇	Color Bin Selection	0	Full range
		K	Color bin 2 and 4
		L	Color bin 4 and 6
x ₈ x ₉	Packaging Option	DD	Ammopack

Bin Information

Intensity Bin Limit Table (1.3 : 1 I_V Bin Ratio)

Bin	Intensity (mcd) at 20 mA	
	Min	Max
U	3200	4200
V	4200	5500
W	5500	7200
X	7200	9300
Y	9300	12000
Z	12000	16000
1	16000	21000
2	21000	27000
3	27000	35000

Tolerance for each bin limit is ±15%.

V_F Bin Table (V at 20 mA)

Bin ID	Min	Max
VD	1.8	2.0
VA	2.0	2.2
VB	2.2	2.4

Tolerance for each bin limit is ±0.05V.

Red Color Range

Min Dom	Max Dom	X Min	Y Min	X Max	Y Max
618.0	630.0	0.6872	0.3126	0.6890	0.2943
		0.6690	0.3149	0.7080	0.2920

Tolerance for each bin limit is ±0.5 nm.

Amber Color Range

Bin	Min Dom	Max Dom	X Min	Y Min	X Max	Y Max
1	584.5	587.0	0.5420	0.4580	0.5530	0.4400
			0.5370	0.4550	0.5570	0.4420
2	587.0	589.5	0.5570	0.4420	0.5670	0.4250
			0.5530	0.4400	0.5720	0.4270
4	589.5	592.0	0.5720	0.4270	0.5820	0.4110
			0.5670	0.4250	0.5870	0.4130
6	592.0	594.5	0.5870	0.4130	0.5950	0.3980
			0.5820	0.4110	0.6000	0.3990

Tolerance for each bin limit is ±0.5 nm.

NOTE: All bin categories are established for classification of products. Products may not be available in all bin categories. Please contact your Broadcom representative for further information.

Figure 2: Color Bin on CIE 1931 Chromaticity Diagram

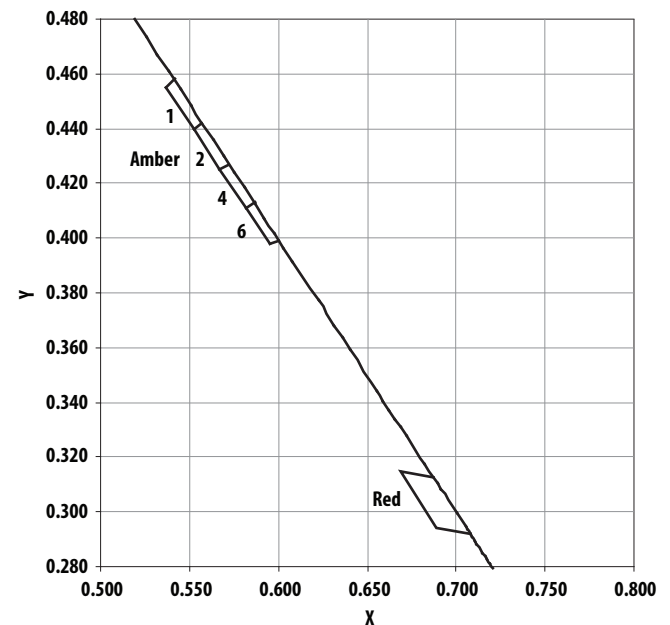

Figure 3: Relative Intensity vs Wavelength

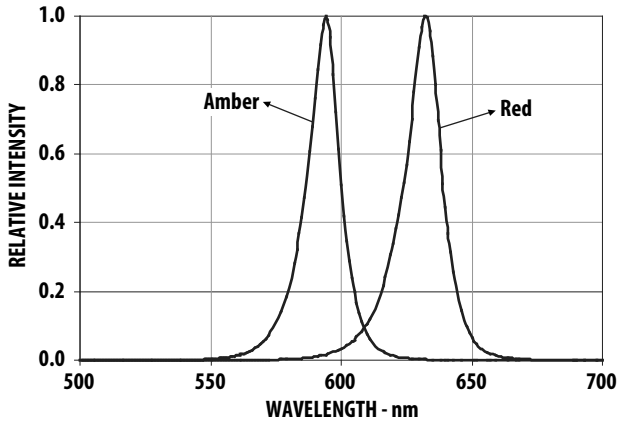

Figure 4: Forward Current vs Forward Voltage

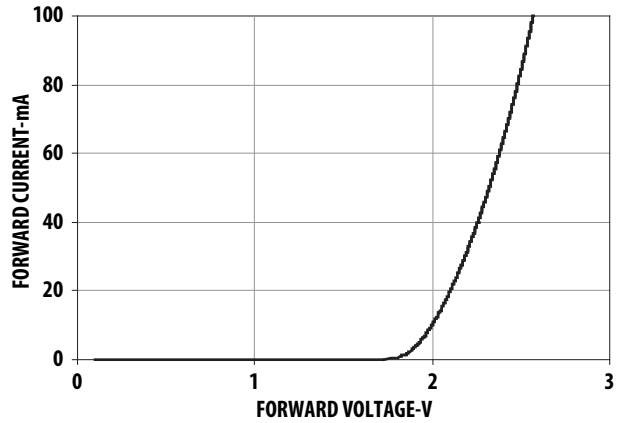

Figure 5: Relative Intensity vs Forward Current

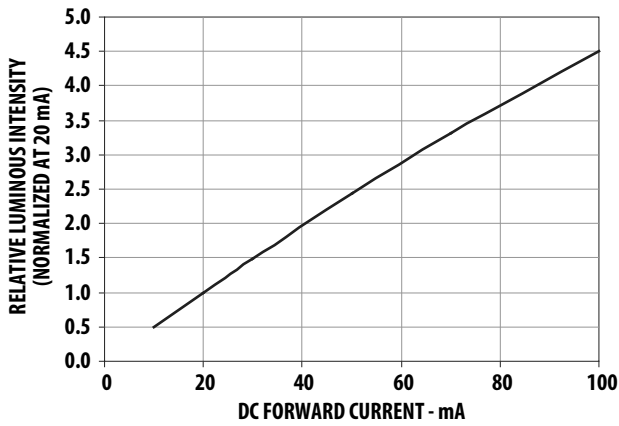

Figure 6: Maximum Forward Current vs Ambient Temperature

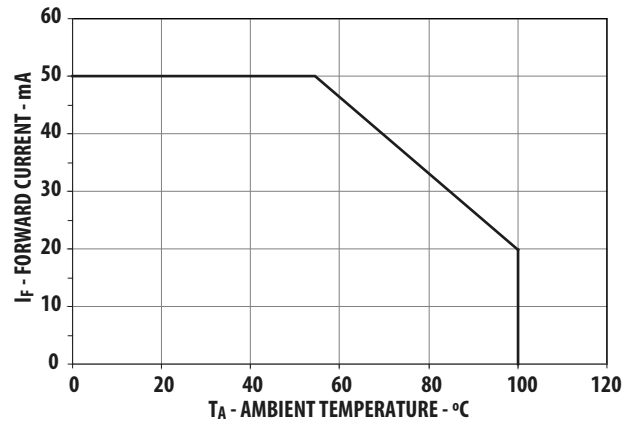

Figure 7: Representative Radiation Pattern for 15° Viewing Angle Lamp

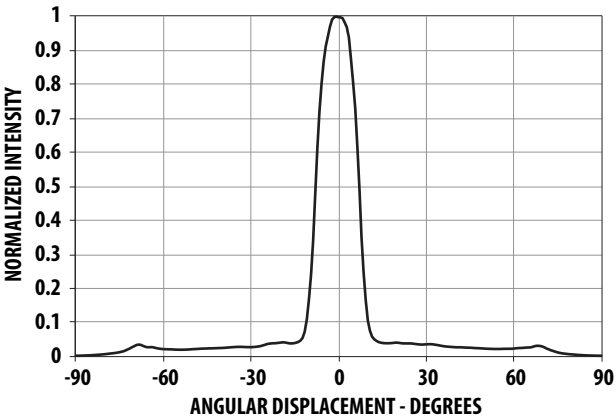

Figure 8: Representative Radiation Pattern for 23° Viewing Angle Lamp

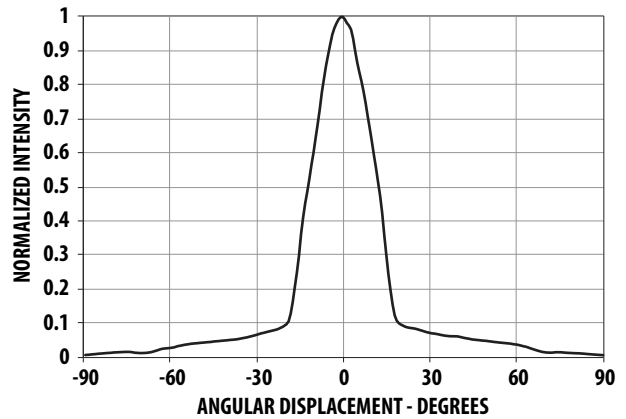

Figure 9: Representative Radiation Pattern for 30° Viewing Angle Lamp



Figure 10: Relative Light Output vs Junction Temperature

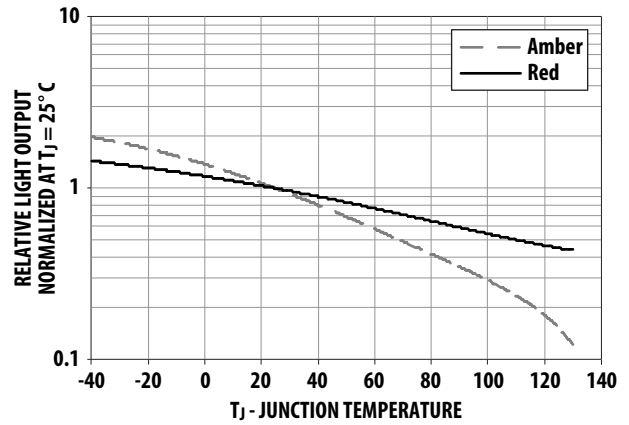

Figure 11: Forward Voltage Shift vs Junction Temperature



Precautionary Notes

Lead Forming

- The leads of an LED lamp can be preformed or cut to length prior to insertion and soldering on PC board.
- For better control, use proper tool to precisely form and cut the leads to applicable length rather than doing it manually.
- If manual lead cutting is necessary, cut the leads after the soldering process. The solder connection forms a mechanical ground, which prevents mechanical stress due to lead cutting from traveling into LED package. This is highly recommended for hand solder operation, as the excess lead length also acts as small heat sink.

Soldering and Handling

- Care must be taken during PCB assembly and soldering process to prevent damage to the LED component.
- The LED component can be effectively hand soldered to PCB. However, it is only recommended under unavoidable circumstances such as rework. The closest manual soldering distance of the soldering heat source (soldering iron's tip) to the body is 1.59 mm. Soldering the LED using soldering iron tip closer than 1.59 mm might damage the LED.



- ESD precaution must be properly applied on the soldering station and personnel to prevent ESD damage to the LED component that is ESD sensitive. Refer to Broadcom application note AN 1142 for details. The soldering iron used should have grounded tip to ensure electrostatic charge is properly grounded.
- Recommended soldering condition:

	Wave Soldering ^{a,b}	Manual Solder Dipping
Preheat Temperature	105°C Max.	—
Preheat Time	60 sec Max	—
Peak Temperature	260°C Max.	260°C Max.
Dwell Time	5 sec Max.	5 sec Max

a. These conditions refer to the measurement with thermocouple mounted at the bottom of PCB.
 b. Use only bottom preheaters to reduce thermal stress experienced by LED.

- Wave soldering parameters must be set and maintained according to the recommended temperature and dwell time. The customer is advised to perform a daily check on the soldering profile to ensure that it is always conforming to recommended soldering conditions.

NOTE:

- A PCB with different size and design (component density) will have different heat mass (heat capacity). This might cause a change in temperature experienced by the board if same wave soldering setting is used. So, it is recommended to recalibrate the soldering profile again before loading a new type of PCB.
- The Broadcom high brightness LEDs are using high-efficiency LED die with single-wire bond as shown in Figure 12. The customer is advised to take extra precaution during wave soldering to ensure that the maximum wave temperature does not exceed 260°C and the solder contact time does not exceeding 5 sec. Overstressing the LED during soldering process might cause premature failure to the LED due to delamination.

Figure 12: LED Configuration

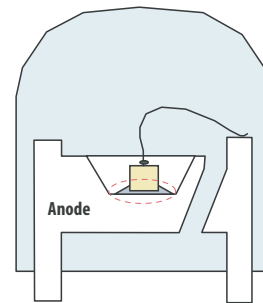

NOTE: Electrical connection between bottom surface of LED die and the lead frame is achieved through conductive paste.

- Any alignment fixture that is being applied during wave soldering should be loosely fitted and should not apply weight or force on the LED. Non-metal material is recommended as it will absorb less heat during wave soldering process.

NOTE: In order to further assist the customer in designing jig accurately to fit the Broadcom product, a 3D model of the product is available upon request.

- At elevated temperature, the LED is more susceptible to mechanical stress. Therefore, the PCB must be allowed to cool down to room temperature prior to handling, which includes removal of alignment fixture or pallet.
- If the PCB board contains both through-hole (TH) LED and other surface mount components, it is recommended that surface mount components be soldered on the top side of the PCB. If surface mount needs to be on the bottom side, these components should be soldered using reflow soldering prior to insertion the TH LED.

- The following table shows the recommended PC board plated through holes (PTH) size for LED component leads:

LED Component Lead Size	Diagonal	Plated Through Hole Diameter
0.45 x 0.45 mm (0.018x 0.018 inch)	0.636 mm (0.025 inch)	0.98 to 1.08 mm (0.039 to 0.043 inch)
0.50 x 0.50 mm (0.020x 0.020 inch)	0.707 mm (0.028 inch)	1.05 to 1.15 mm (0.041 to 0.045 inch)

- Oversizing the PTH can lead to twisted LED after clinching. On the other hand, undersizing the PTH can cause difficulty inserting the TH LED.

Refer to the Broadcom application note AN5334 for more information about soldering and handling of high brightness TH LED lamps.

Figure 13: Example of Wave Soldering Temperature Profile for TH LED



Recommended solder:

Sn63 (Leaded solder alloy)

SAC305 (Lead free solder alloy)

Flux: Rosin flux

Solder bath temperature: 255°C ± 5°C
(maximum peak temperature = 260°C)

Dwell time: 3.0 sec - 5.0 sec
(maximum = 5sec)

Note: Allow for board to be sufficiently cooled to room temperature before exerting mechanical force.

Figure 14: Ammo Packs Drawing

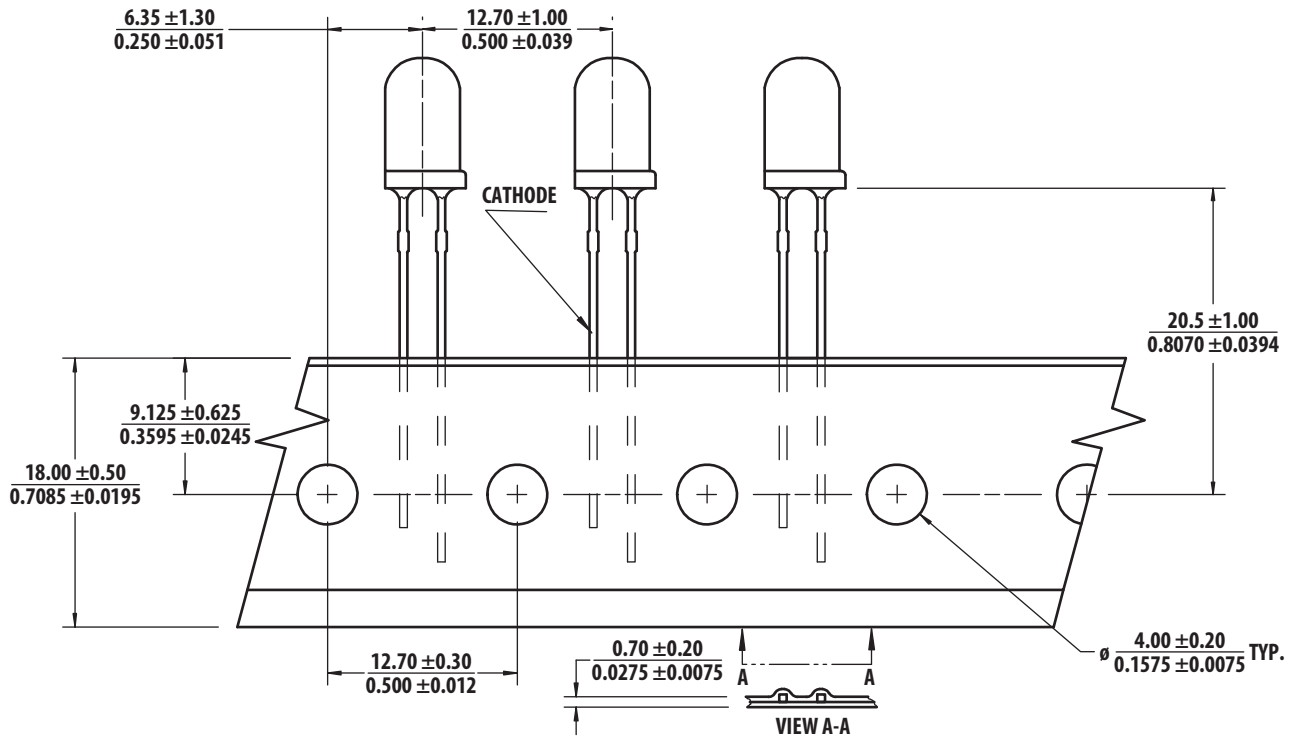

NOTE: The ammo-packs drawing is applicable for packaging option -DD and -ZZ and regardless standoff or non-standoff.

Figure 15: Packaging Box for Ammo Packs



NOTE: The dimension for ammo pack is applicable for the device with standoff and without standoff.

Packaging Labels

Figure 16: (i) Mother Label (Available on packaging box of ammo pack and shipping box)

AVAGO TECHNOLOGIES	
(1P) Item: Part Number 	STANDARD LABEL LS0002 RoHS Compliant e3 max temp 260C
(1T) Lot: Lot Number 	(Q) QTY: Quantity 
LPN: 	CAT: Intensity Bin 
(9D)MFG Date: Manufacturing Date 	BIN: Refer to below information
<hr/>	
(P) Customer Item: 	
(V) Vendor ID: 	(9D) Date Code: Date Code 
<hr/>	
DeptID: 	Made In: Country of Origin 

Figure 17: (ii) Baby Label (Only available on bulk packaging)

AVAGO TECHNOLOGIES	
Lamps Baby Label	
RoHS Compliant e3 max temp 260C	
(1P) PART #: Part Number 	
(1T) LOT #: Lot Number 	
(9D)MFG DATE: Manufacturing Date 	QUANTITY: Packing Quantity 
C/O: Country of Origin	
<hr/>	
Customer P/N: 	CAT: Intensity Bin 
Supplier Code: 	BIN: Refer to below information 
	DATECODE: Date Code 

Acronyms and Definitions

BIN:

- (i) Color bin only or V_F bin only

Applicable for part number with color bins but without V_F bin OR part number with V_F bins and no color bin.

OR

- (ii) Color bin incorporated with V_F Bin

Applicable for part number that have both color bin and V_F bin.

Example:

- (i) Color bin only or V_F bin only

BIN: 2 (represent color bin 2 only)

BIN: VB (represent V_F bin VB only)

- (ii) Color bin incorporate with V_F Bin

BIN: 2 VB

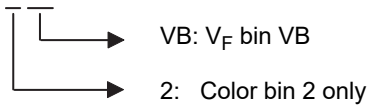

Disclaimer

Broadcom's products and software are not specifically designed, manufactured, or authorized for sale as parts, components, or assemblies for the planning, construction, maintenance, or direct operation of a nuclear facility or for use in medical devices or applications. The customer is solely responsible, and waives all rights to make claims against Broadcom or its suppliers, for all loss, damage, expense, or liability in connection with such use.

Broadcom, the pulse logo, Connecting everything, Avago Technologies, Avago, and the A logo are among the trademarks of Broadcom and/or its affiliates in the United States, certain other countries and/or the EU.

Copyright © 2017–2018 Broadcom. All Rights Reserved.

The term “Broadcom” refers to Broadcom Limited and/or its subsidiaries. For more information, please visit www.broadcom.com.

Broadcom reserves the right to make changes without further notice to any products or data herein to improve reliability, function, or design. Information furnished by Broadcom is believed to be accurate and reliable. However, Broadcom does not assume any liability arising out of the application or use of this information, nor the application or use of any product or circuit described herein, neither does it convey any license under its patent rights nor the rights of others.

