

Single Row Terminal Blocks

A3, LP3 & CB3

Dimensions Inches (Millimeters)

A3 & LP3



A31930307

LP307102

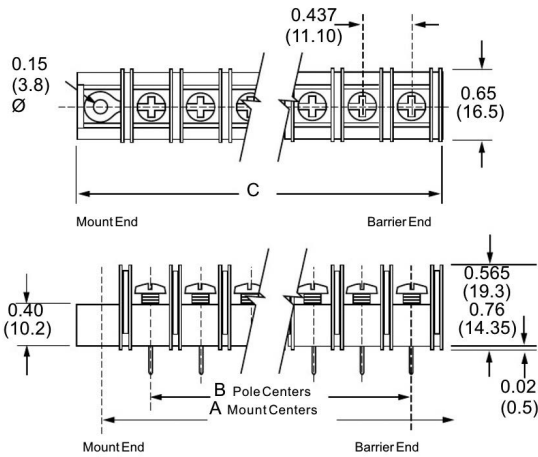

CB3



CB35110407MP

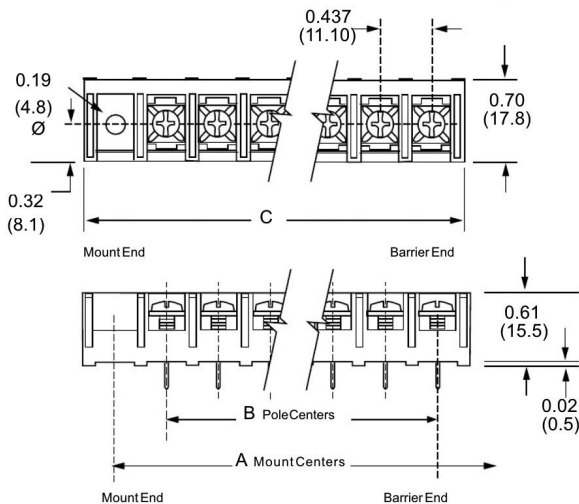

Specifications

Rating: A3: 30A, 600V* LP3: 30A, 150V* CB3: 30A, 600V*

Wire Range: #12-22 AWG Cu

Center Spacing: 0.437" or 7/16" (11.10mm)

Screw Size: #6-32 zinc-plated phillslot screws.

Torque Rating: 9 lb-in.

Base: Standoffs standard for easy flux washing.

Distance Between Barriers: 0.32" (8.1mm)

Recommended PCB Hole Diameter: 0.076" (1.93mm)

Operating Temperature: 105°C (221°F) max., -40°C (-40°F) min.

Molded Material: Black, UL Rated 94V0 Thermoplastic

Breakdown Voltage: 3500V (A3 & LP3); 8200V (CB3)

Agency Information: UL File E62622, CSA 47235; IEC Compliance, CE Certified

* 30A Rating achieved with a #10 copper wire crimped to a ring terminal; 20 Rating without ring terminal.

| Poles | MOUNTING ENDS ONLY | | BARRIER & MOUNTING ENDS | |
|-------|--------------------|----------|-------------------------|----------|
| | A Mounting Ctrs. | C Length | B Pole Ctrs. | C Length |
| 02 | 1.31 | 1.73 | 0.43 | 0.98 |
| 03 | 1.75 | 2.17 | 0.87 | 1.43 |
| 04 | 2.18 | 2.61 | 1.31 | 1.87 |
| 05 | 2.62 | 3.05 | 1.75 | 2.31 |
| 06 | 3.06 | 3.48 | 2.18 | 2.75 |
| 07 | 3.50 | 3.92 | 2.62 | 3.18 |
| 08 | 3.93 | 4.36 | 3.06 | 3.62 |
| 09 | 4.37 | 4.80 | 3.50 | 4.06 |
| 10 | 4.81 | 5.23 | 3.93 | 4.50 |
| 11 | 5.25 | 5.67 | 4.37 | 4.93 |
| 12 | 5.68 | 6.11 | 4.81 | 5.37 |
| 13 | 6.12 | 6.55 | 5.25 | 5.81 |
| 14 | 6.56 | 6.98 | 5.68 | 6.25 |
| 15 | 7.00 | 7.42 | 6.12 | 6.68 |
| 16 | 7.43 | 7.86 | 6.56 | 7.12 |
| 17 | 7.87 | 8.30 | 7.00 | 7.56 |
| 18 | 8.31 | 8.73 | 7.43 | 8.00 |
| 19 | 8.75 | 9.17 | 7.87 | 8.43 |
| 20 | 9.18 | 9.60 | 8.31 | 8.87 |
| 21 | 9.62 | 10.05 | 8.50 | 9.31 |
| 22 | 10.06 | 10.48 | 9.18 | 9.75 |
| 23 | 10.50 | 10.92 | 9.62 | 10.18 |
| 24 | 10.93 | 11.36 | 10.06 | 10.62 |
| 25 | 11.37 | 11.80 | 10.50 | 11.06 |
| 26 | 11.81 | 12.23 | 10.98 | 11.50 |
| 27 | - | - | 11.81 | 12.37 |
| 28 | - | - | 11.37 | 11.07 |



Powering Business Worldwide

Part Numbering System

| Family | Terminal Style | Base/End | Poles | Screw Options | Options |
|------------------------------|--|--|--|--|--|
| A 3 | | | | | |
| A3 - standard barrier | 01 - handwired 02 - printed circuit 03 - non feed-thru 04 - wire wrap tail 05 - extended handwired 07 - extended pin 09 - 0.250 QC short 10 - 0.187 QC 19 - 0.250 QC long | 1 - std. base/mount end 2 - std. base/barrier 3* - insulator base/mount end 4* - insulator base/barrier end 5** - closed base/mount end | 02 to 28 barrier end 02 to 26 mount end | Blank-std. screws 03 - stainless steel 04 - brass nickel-plated 07 - steel SEMS zinc-plated*** 09 - brass SEMS nickel-plated*** 07WR - steel SEMS wire ready CA† - captive screw | AB - angle mnt. options (pg 18) A1 to A9 - 0.250" QC B1 to B9 - 0.187" QC L1 to L6 marking options (pg 25) MP, MT - mounting plates (pg 18) RC - retaining clips (pg 18) R30 to R66 - right angle bends (pg 18) |

* Base/End Styles 3 and 4 not available with 02, 03, and 09 terminals.

** Base/End Note: 5 Style only available with 03 terminals.

*** SEMS screws not available with hardware options

† Not compatible with 03 stainless steel screw option.

Terminal Styles Inches (Millimeters)

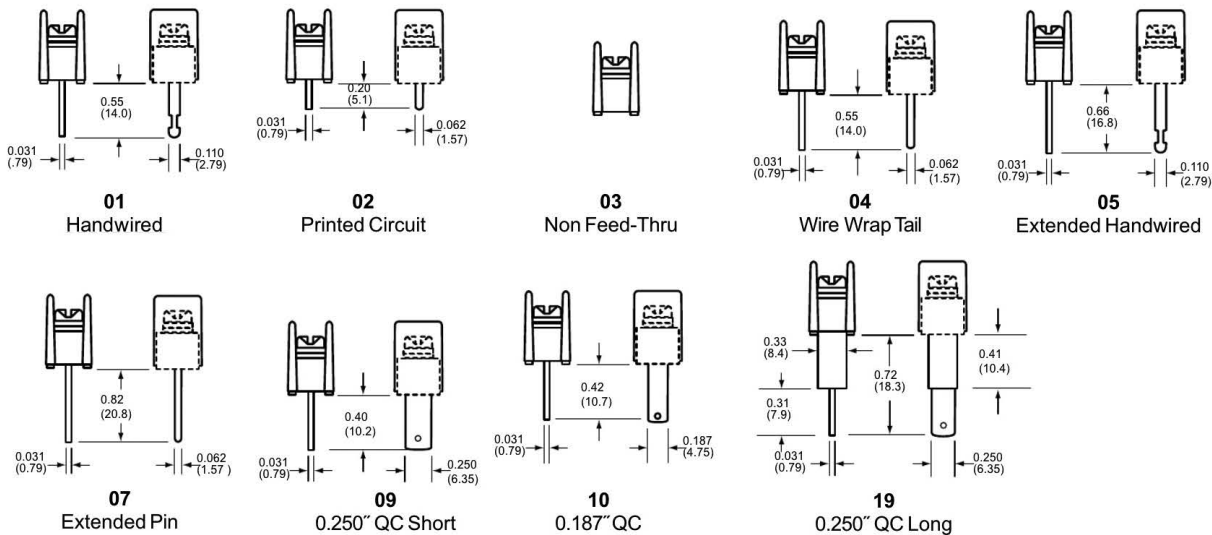



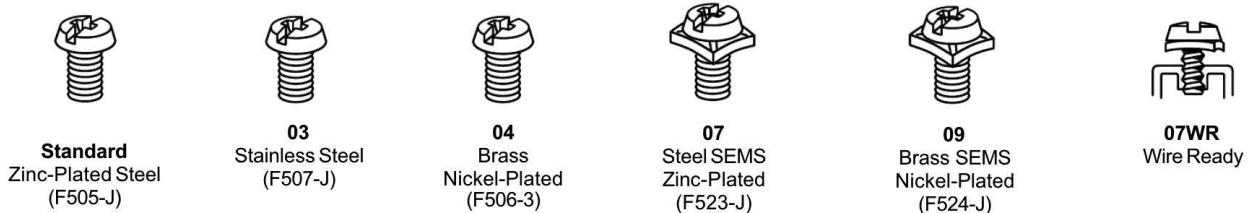

Screw Options

(Bulk ordering part numbers are in parentheses)

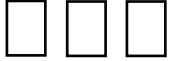

Part Numbering System

| Family | Terminal Style | Base/End | Poles | Screw Options | Options |
|--|--|---|--|--|--|
|  <p>LP3 - low profile barrier</p> |  <p>01 - handwired 02 - printed circuit 03 - non feed-thru 04 - wire wrap tail 05 - extended handwired 07 - extended pin</p> |  <p>1 - std. base/mount end 2 - std. base/barrier 3* - insulator base/mount end 4* - insulator base/barrier end 5** - closed base/mount end</p> |  <p>02 to 28 barrier end 02 to 26 on mount end</p> |  <p>Blank-std. screws 00 - screws shipped 04 - brass nickel-plated 07 - steel SEMS zinc-plated*** CA - captive screw</p> |  <p>A1 to A9 - 0.250" QC B1 to B9 - 0.187" QC L1 to L6 marking options (pg 25) MP - mounting plates (pg 18) R30 to R66 - right angle bends (pg 18)</p> |

* A2 only.
 ** Not compatible with 03-stainless steel screws.
 *** SEMS screws not available with hardware options

Terminal Styles Inches (Millimeters)

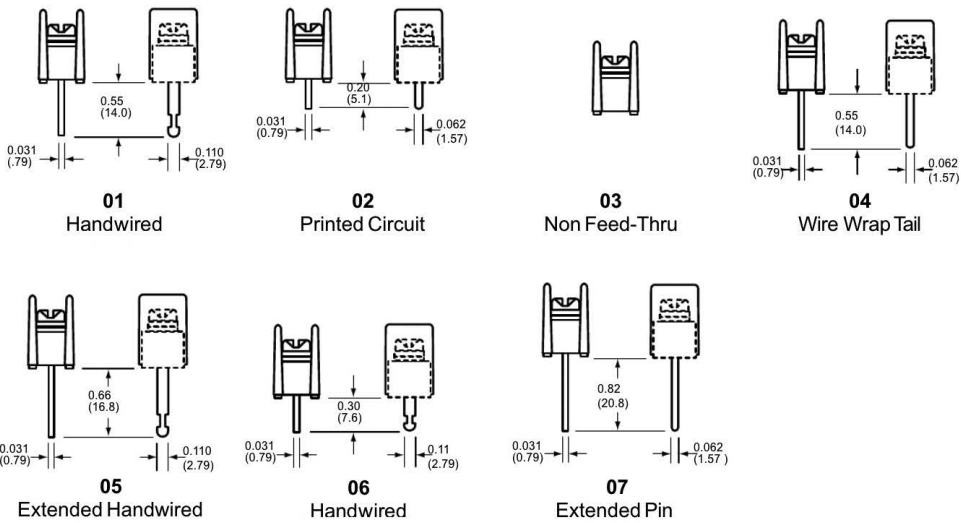

Screw Options

(Bulk ordering part numbers are in parentheses)

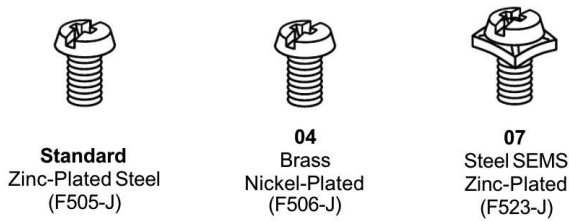

Hardware Options Inches (Millimeters)

(Bulk ordering part numbers are in parentheses)

Jumpers



†J201
Flatslip-on
(J201-J)



†OJ3
(OJ3-J)



†OJ7
LP3 Only
(OJ7-J)



†OJ5
(OJ5-J)

† Contact Eaton for desired configuration.

Quick Connects Blade Width A = 0.250" Blade Width B = 0.187"

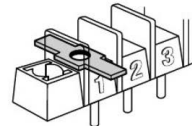

A1 & B1
(2A1-J & 2B1-J)

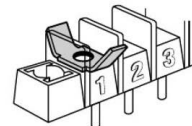

A2 & B2
(2A2-J & 2B2-J)

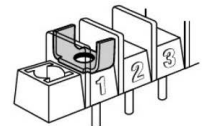

A3 & B3
(2A3-J & 2B3-J)

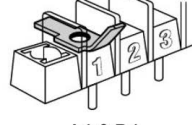

A4 & B4
(2A4-J & 2B4-J)



A5 & B5
(2A5-J & 2B5-J)

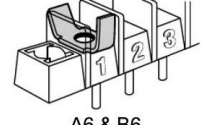

A6 & B6
(2A6-J & 2B6-J)

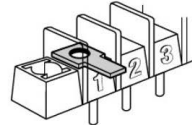

A7 & B7
(2A7-J & 2B7-J)



A8 & B8
(2A8-J & 2B8-J)

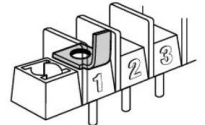

A9 & B9
(2A9-J & 2B9-J)

Base/End Options Inches (Millimeters)



1 - Standard base/mount end



2 - Standard base/barrier end



3 - Insulator base/mount end

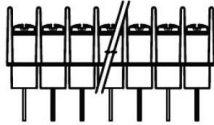
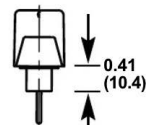

4 - Insulator base/barrier end

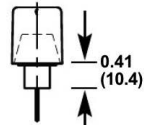

5 - Closed base/mount end



Mount End Details

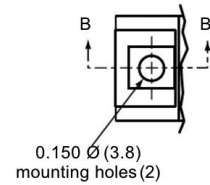

0.150 Ø (3.8)
mounting holes (2)

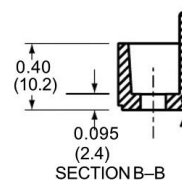

SECTION B-B

1, 3 & 5 Mount End

Note: On 1, 3 and 5 bases, Eaton may drill a terminal spacing to be a mount end. There will be no fit/form/function effect of mounting the product

Mounting Options Inches (Millimeters)

Right Angle Mounting Bracket

Right angle terminals are offered on the A3 & LP3. Configurations are defined in these dimensions: X = pin extension beyond the block base; Z = length from block base to centerline of the terminal tip. Standard bends consist of the X and Z dimensions shown in the chart. Specify by adding the selected Bend Option Code to the terminal part number.

04 Terminal Bend Configurations

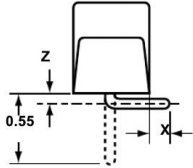

| Bend Option Code | X (minimum) | Z | Available w/insulator base |
|------------------|-------------|------|----------------------------|
| R36 | 0.02 | 0.22 | No |
| R42 | 0.08 | 0.16 | No |
| R46 | 0.12 | 0.12 | No |
| R50 | 0.16 | 0.08 | No |

Dimensions in inches. To convert to millimeters, multiply by 25.4.

07 Terminal Bend Configurations

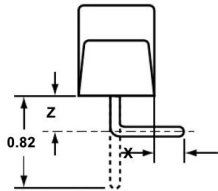

| Bend Option Code | X (minimum) | Z | Available w/insulator base |
|------------------|-------------|------|----------------------------|
| R36 | 0.02 | 0.49 | Yes |
| R50 | 0.16 | 0.35 | No |
| R66 | 0.32 | 0.19 | No |

Dimensions in inches. To convert to millimeters, multiply by 25.4.

Angle Brackets (A3 only)

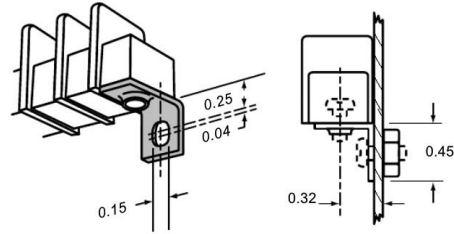

Option AB

Angle brackets enable block to be fastened at right angles to normal mount position. Bulk part number **2AB-J**.

Mounting Plates

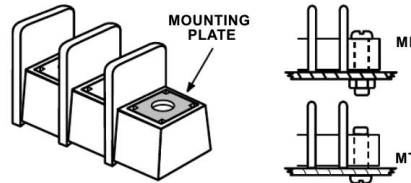

Options MP & MT

MP Metal inserts with 0.150" dia. hole accept #6 screw.

MT Metal inserts with tapped hole accept #6-32 screw.

Bulk part number **2MP-J, 2MT-J**.

Retaining Clip

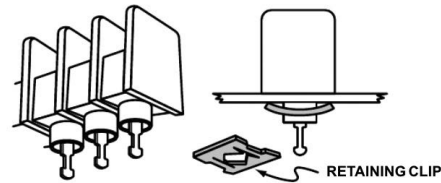

Options RC

Use on standoff tubes. Fit panels up to 0.125" thick. Two clips for every five positions. Supplied unassembled. Bulk part number **H541-J**.

Part Numbering System

Family



CB3 - closed back

Terminal Style

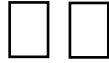

01 - handwired
#6-32 screw

02 - printed circuit
#6-32 screw

07 - extended pin
#6-32 screw

51* - handwired
#8-32 screw

52* - printed circuit
#8-32 screw

Base/End



1 - mount end

2 - barrier end

Poles



02 to 22 barrier
end

02 to 20
on mount
end

Screw Options

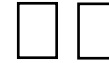

07 - steel SEMS
(standard)

09 - brass SEMS
nickel-plated

CA - SEMS captive

Options

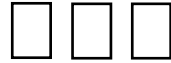

A7 to A9 - 0.250" QC

B7 to B9 - 0.187" QC

EB exit back terminals
L1 to L6 marking options
(pg 25)

LT1 to LT6 marking options
(pg 25)

MP mtg. plates (pg 20)

Covers - (pg 26)

*Note: #8-32 screw is a special with #6-32 head.

Terminal Styles Inches (Millimeters)

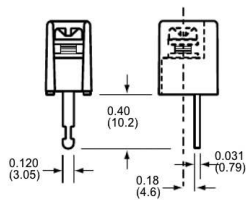

01

Handwired #6-32 screw

51

Handwired #8-32 screw

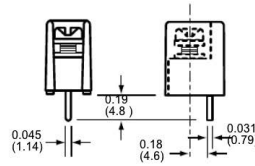

02

Printed Circuit #6-32 screw

52

Printed Circuit #8-32 screw

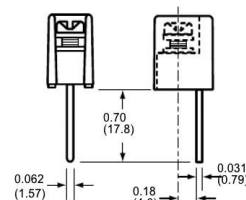

07

Extended Pin #6-32
screw

Screw Options

(Bulk ordering part numbers are in parentheses)



07

Steel SEMS
Zinc-Plated
(standard)
(B001-7084-J)



09

Brass SEMS
Nickel-Plated
(F524-J)

CB3 Terminal Exit Options Inches (Millimeters)

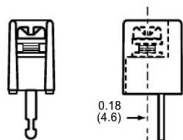

Exit Rear (std.)

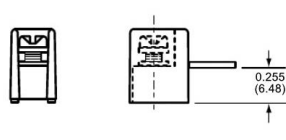

EB
Exit Back

Hardware Options

Inches (Millimeters)

(Bulk ordering part numbers are in parentheses)



†OJ3
(OJ3-J)

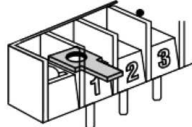

A7 & B7
(2A7-J & 2B7-J)

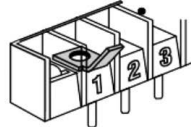

A8 & B8
(2A8-J & 2B8-J)



A9 & B9
(2A9-J & 2B9-J)



†OJ7
(OJ7-J)

† Contact Eaton for desired configuration.

Mounting Options Inches (Millimeters)

Mounting Plates

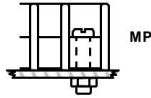
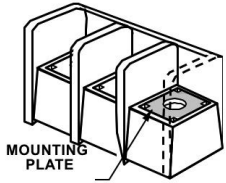

Options MP

MP Metal inserts with 0.150" dia. hole accept #6 screw.

Contact Us

Sales and Customer Service

Americas

Email: elx.americas@eaton.com

Europe, Middle East, Africa

Email: elx.emea@eaton.com

China

Email: elx.cn@eaton.com

Japan

Email: elx.jp@eaton.com

Korea

Email: elx.kr@eaton.com

South East Asia

Email: elx.sea@eaton.com

Taiwan

Email: elx.tw@eaton.com

Global Technical Support

Magnetics: InductorTech@eaton.com

Circuit Protection: FuseTech@eaton.com

Supercapacitors: CapacitorTech@eaton.com

www.eaton.com/terminalblocks

Tools

Eaton's Electronics Product Selection Tools



PARAMETRIC SEARCH

Drill down into the Eaton Electronics product database to find the right part for your application.



IC MATCHING

Find the Eaton Electronics parts called out on IC manufacturers' demo and evaluation boards.



CROSS REFERENCE

Find a cross to a competitor's product or to an alternate Eaton Electronics part number.



SUPERCAPACITOR CALCULATOR

Determine your calculated requirements and design capability.



TERMINAL BLOCK SELECTOR

Find the right terminal block for any application.



AUTOMOTIVE ELECTRONICS SOLUTIONS

Find electronics components for automotive solutions.

tools.eatonelectronics.com