

DELPHI SERIES

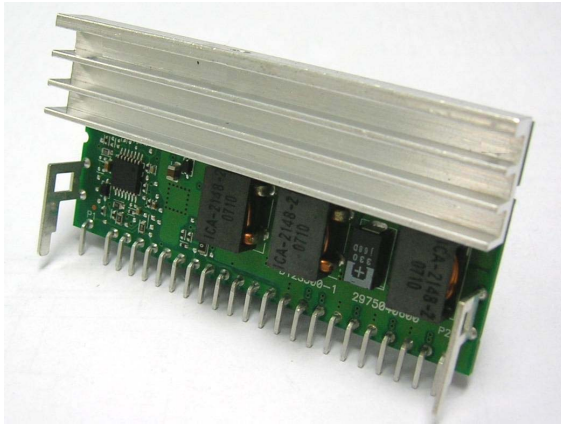

FEATURES

- ◆ High Efficiency:
94% @ 12Vin, 5.0V/60A out
- ◆ Wide input range: 4.5V~13.8V
- ◆ Output voltage programmable from 0.6Vdc to 5.0Vdc via external resistors
- ◆ No minimum load required
- ◆ Fixed frequency operation
- ◆ Input UVLO, output OCP, OVP.
- ◆ Remote On/Off (Positive logic)
- ◆ Power Good Function
- ◆ RoHs completed
- ◆ ISO 9001, TL 9000, ISO 14001, QS9000, OHSAS18001 certified manufacturing facility

Delphi D12S300-1 Non-Isolated Point of Load DC/DC Modules: 4.5V~13.8Vin, 0.6V~5.0Vout, 60A

The D12S300-1 series, 4.5~13.8V input, single output, non-isolated point of load DC/DC converters are the latest offering from a world leader in power systems technology and manufacturing -- Delta Electronics, Inc. The D12S300-1 series product provides up to 60A and the output can be resistor trimmed from 0.6Vdc to 5.0Vdc. It provides a very cost effective point of load solution. With creative design technology and optimization of component placement, these converters possess outstanding electrical and thermal performance, as well as extremely high reliability under highly stressful operating conditions. The D12S300-1 series is a voltage mode controlled Buck topology. The output can be trimmed in the range of 0.6Vdc to 5.0Vdc by an external resistor from Trim pin to Ground. The converter can be turned ON/OFF by remote control with positive on/off (ENABLE pin) logic. The converter DC output is disabled when the signal is driven low. When this pin is floating the module will turn on. The converter can protect itself by entering hiccup mode against over current and short circuit condition. Also, the converter will shut down when an over voltage protection is detected.

DATASHEET
DS_D12S300-1_12282009

OPTIONS

APPLICATIONS

- ◆ Telecom/DataCom
- ◆ Distributed power architectures
- ◆ Servers and workstations
- ◆ LAN/WAN applications
- ◆ Data processing applications

TECHNICAL SPECIFICATIONS

(Ambient Temperature=25°C, minimum airflow=100LFM, nominal V_{in} =12Vdc unless otherwise specified.)

PARAMETER	NOTES and CONDITIONS	D12S300-1			
		Min.	Typ.	Max.	Units
ABSOLUTE MAXIMUM RATINGS					
Input Voltage	Continuous	-0.3		13.8	Vdc
Operating Temperature	Refer to Fig.32 for the measuring point	0		70	°C
Storage Temperature		-55		125	°C
INPUT CHARACTERISTICS					
Operating Input Voltage		4.5		13.8	Vdc
Input Under-Voltage Lockout					
Turn-On Voltage Threshold			4.38		Vdc
Turn-Off Voltage Threshold			3.88		Vdc
Lockout Hysteresis Voltage			0.4		V
Maximum Input Current	$V_{in}=12V, V_{out}=5V, I_o=60A$			28	A
No-Load Input Current	$V_{in}=12V, V_{out}=5V, I_o=0A$		530	600	mA
Off Converter Input Current	Remote OFF		24	30	mA
Input Reflected-Ripple Current	P-P thru 2uH inductor 5Hz to 20MHz		30		mA
Input Voltage Ripple Rejection	120Hz		50		dB
Output Short-Circuit Input Current	$V_{in}=12V, V_{out}=5V$		160		mA
OUTPUT CHARACTERISTICS					
Output Voltage Adjustment Range		0.6		5.0	V
Output Voltage Set Point	With a 0.1% trim resistor	-0.8	0.1	+0.8	%Vo
Output Voltage Regulation					
Over Load	$I_o=I_{o_min}$ to I_{o_max}	-0.5	0.1	+0.5	%Vo
Over Line	$V_{in}=V_{in_min}$ to V_{in_max}	-0.2		+0.2	%Vo
Total output range	Over load, line, temperature regulation and set point	-1.5		+1.5	%Vo
Output Voltage Ripple and Noise					
Peak-to-Peak	5Hz to 20MHz bandwidth				
	Full Load, 20uF Tan cap&1uF ceramic, total input & output range		20	50	mV
RMS	Full Load, 10uF Tan cap&1uF ceramic, total input & output range		8	15	mV
Output Current Range		0		60	A
Output Voltage Under-shoot at Power-Off	$V_{in}=12V, \text{Turn OFF}$			100	mV
Output short-circuit current, RMS value	12Vin, 5Vout		10		A
Output DC Current-Limit Inception	Hiccup mode	110		180	%
Over Voltage Protection	Hiccup mode	120	125	130	%
DYNAMIC CHARACTERISTICS					
Output Dynamic Load Response					
Transient Response	12Vin, 1uF ceramic, 10uF Tan cap				
Transient Response	Output step load=25% load for all range Slew rate=10A/μs	0.6 Vo	110	160	mV pk
Transient Response	Output step load=25% load for all range Slew rate=10A/μs	0.9 Vo	120	170	mV pk
Transient Response	Output step load=25% load for all range Slew rate=10A/μs	1.2 Vo	120	170	mV pk
Transient Response	Output step load=25% load for all range Slew rate=10A/μs	1.5 Vo	120	170	mV pk
Transient Response	Output step load=25% load for all range Slew rate=10A/μs	1.8 Vo	100	150	mV pk
Transient Response	Output step load=25% load for all range Slew rate=10A/μs	2.5Vo	100	150	mV pk
Transient Response	Output step load=25% load for all range Slew rate=10A/μs	3.3 Vo	100	150	mV pk
Transient Response	Output step load=25% load for all range Slew rate=10A/μs	5.0 Vo	100	150	mV pk
Settling Time			20	60	μs
Turn-On Transient					
Rise Time	From 10% to 90% of Vo		1	2	ms
Turn-on Delay (Power)	$V_{in}=12V, I_o=\text{min-max. (within 10% of } V_o)$		4	10	ms
Turn-on Delay (Remote on/off)	$V_{in}=12V, I_o=\text{min-max. (within 10% of } V_o)$		0.4	2	ms
Turn on & turn off Transient (overshoot)			0.5%		Vo
Minimum Output Capacitance		0		5000	μF
EFFICIENCY					
Vo=0.6V	$V_{in}=12V, I_o=60A$	76	78		%
Vo=0.9V	$V_{in}=12V, I_o=60A$	81	83		%
Vo=1.2V	$V_{in}=12V, I_o=60A$	84	86.5		%
Vo=1.5V	$V_{in}=12V, I_o=60A$	86	88.5		%
Vo=1.8V	$V_{in}=12V, I_o=60A$	88	90.0		%
Vo=2.5V	$V_{in}=12V, I_o=60A$	90	92.1		%
Vo=3.3V	$V_{in}=12V, I_o=60A$	91	93.4		%
Vo=5.0V	$V_{in}=12V, I_o=60A$	92	94.5		%
SINK EFFICIENCY					
Vo=5.0V	$V_{in}=12V, I_o=60A$		93		%
FEATURE CHARACTERISTICS					
Switching Frequency	Fixed		500		KHz
ON/OFF Control	Positive logic (internally pulled high)				
Logic High	Module On (or leave the pin open)	1.5		4.1	V
Logic Low	Module Off	-0.3		1.4	V
Remote Sense Range				0.5	V
Power Good	Vo is out off +/-10% Vo	0		0.4	V
	Vo is within +/-10% Vo	4.0		5.1	V
Output to Power Good Delay Time			0.1	2	ms
GENERAL SPECIFICATIONS					
Calculated MTBF	25 , 300LFM, 80% load		TBD		Mhours
Weight			26.5		grams
Over-Temperature Shutdown	Refer to Figure 32 for the measuring point		115		°C



ELECTRICAL CHARACTERISTICS CURVES

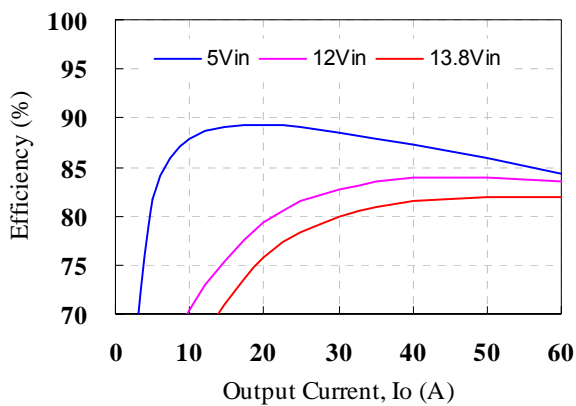

Figure 1: Converter efficiency vs. output current (0.9V output voltage, 5V & 12V input)

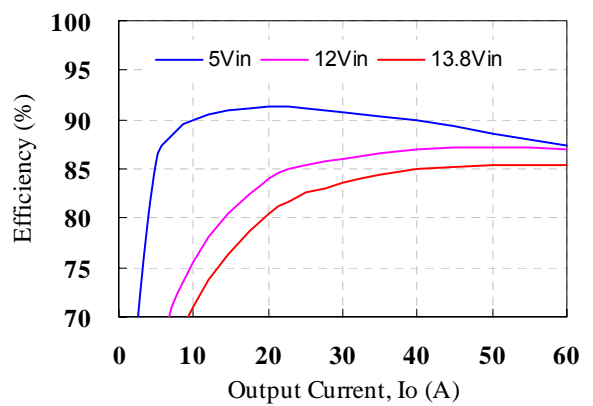

Figure 2: Converter efficiency vs. output current (1.2V output voltage, 5V & 12V input)

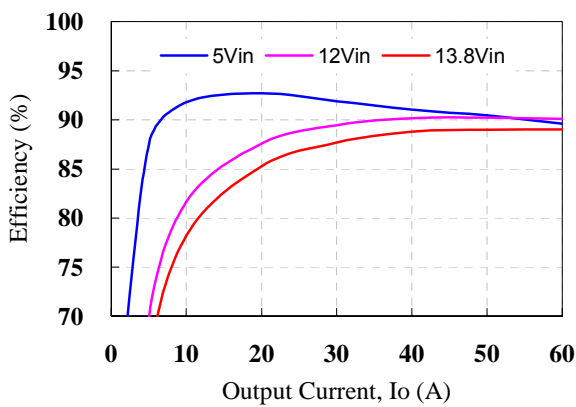

Figure 3: Converter efficiency vs. output current (1.8V output voltage, 5V & 12V input)

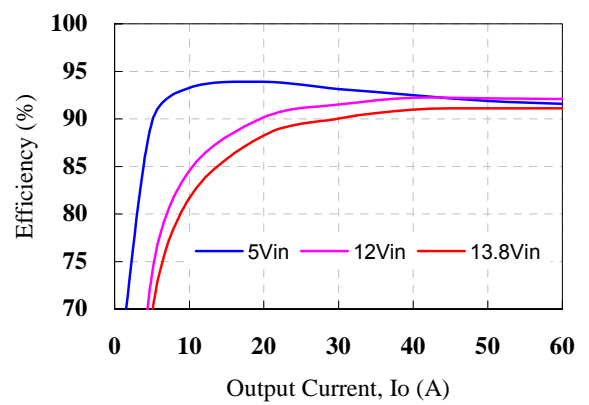

Figure 4: Converter efficiency vs. output current (2.5V output voltage, 5V & 12V input)

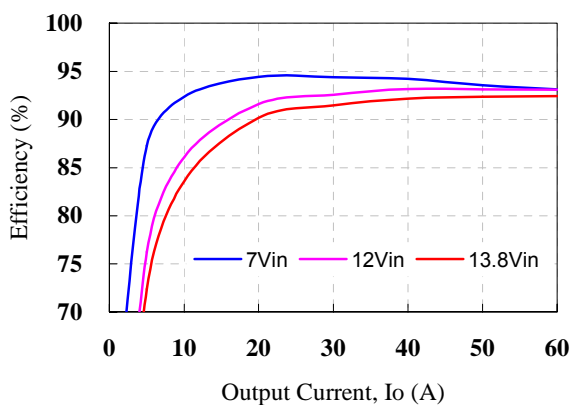

Figure 5: Converter efficiency vs. output current (3.3V output voltage, 12V input)

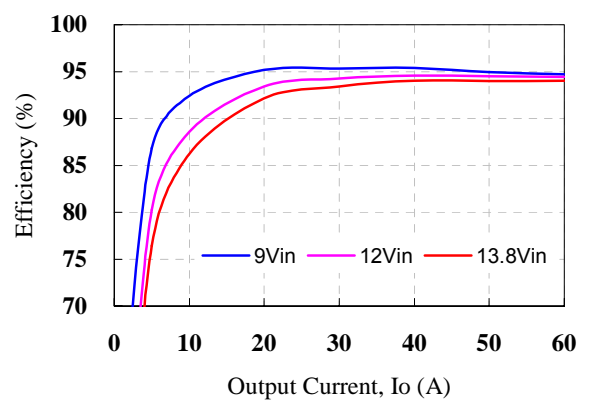

Figure 6: Converter efficiency vs. output current (5.0V output voltage, 12V input)



ELECTRICAL CHARACTERISTICS CURVES (CON.)

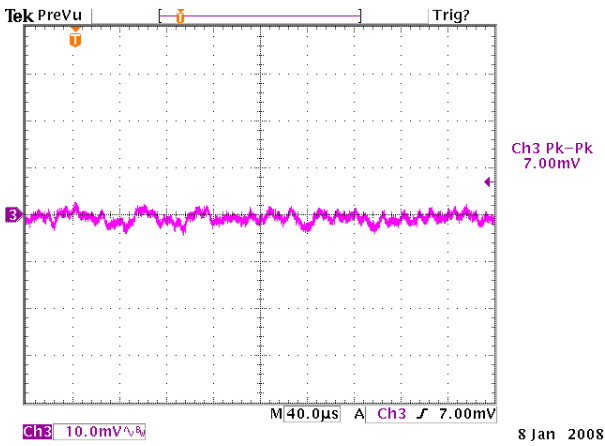

Figure 7: Output ripple & noise at 12Vin, 0.9V/60A out (5mv/div, 1uS/div)

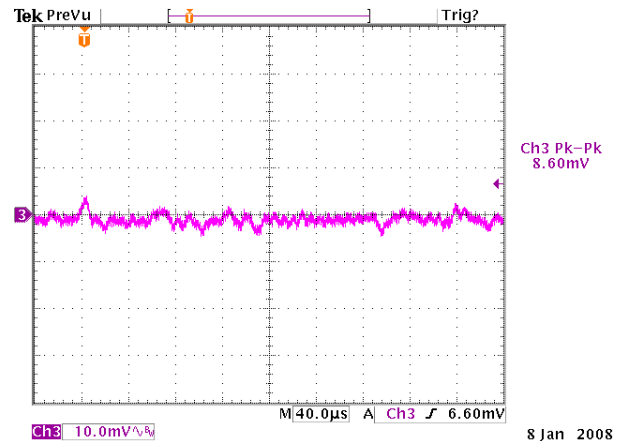

Figure 8: Output ripple & noise at 12Vin, 1.2V/60A out (5mv/div, 1uS/div)

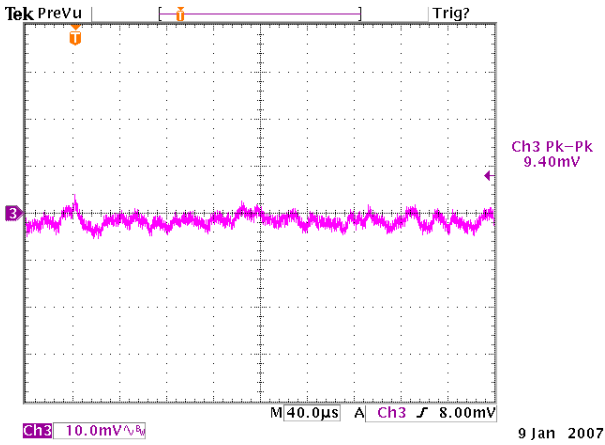

Figure 9: Output ripple & noise at 12Vin, 1.8V/60A out (5mv/div, 1uS/div)

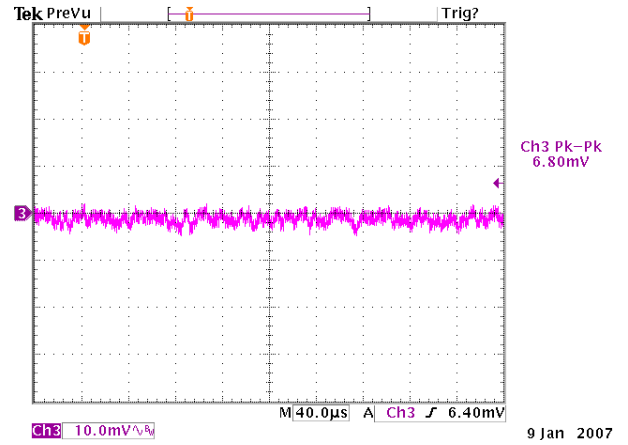

Figure 10: Output ripple & noise at 12Vin, 2.5V/60A out (5mv/div, 1uS/div)

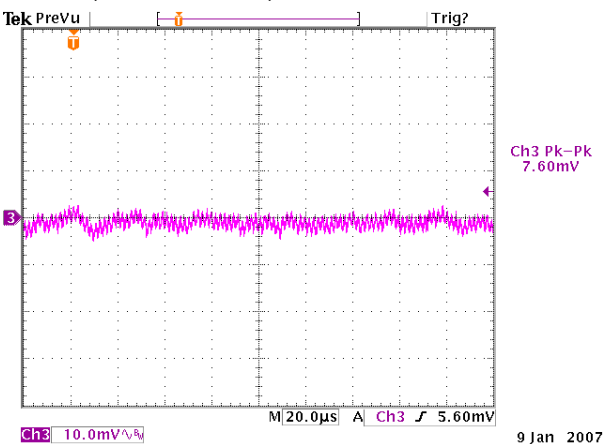

Figure 11: Output ripple & noise at 12Vin, 3.3V/60A out (10mv/div, 1uS/div)

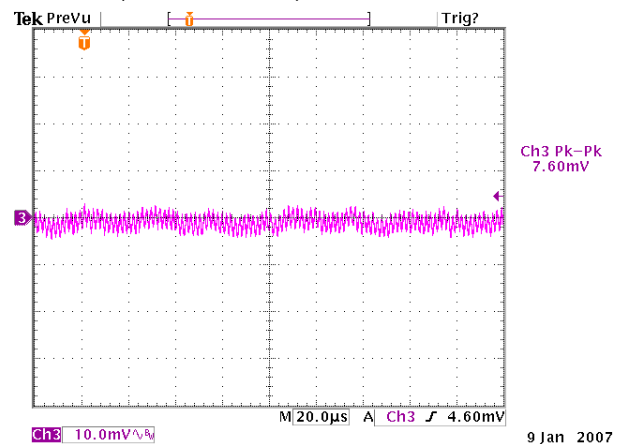

Figure 12: Output ripple & noise at 12Vin, 5.0V/60A out (10mv/div, 1uS/div)



ELECTRICAL CHARACTERISTICS CURVES (CON.)

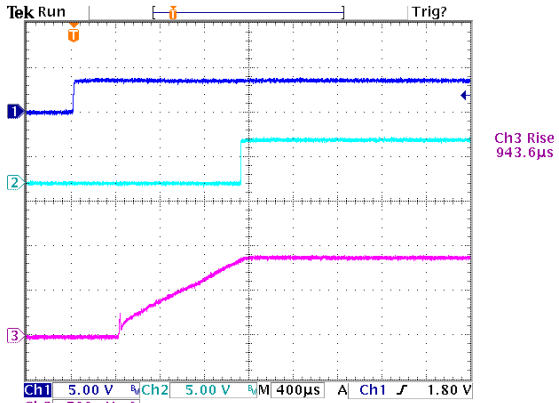

Figure 13: Turn on delay time at 12Vin, 0.9V/60A out (1mS/div)
Ch1: Enable, Ch2: PG, Ch3: Vo

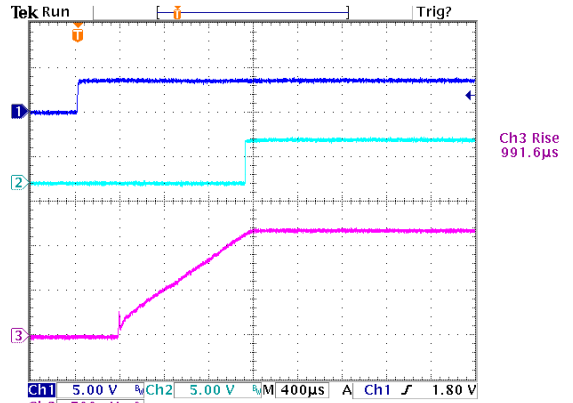

Figure 14: Turn on delay time at 12Vin, 1.2V/60A out (1mS/div)
Ch1: Enable, Ch2: PG, Ch3: Vo

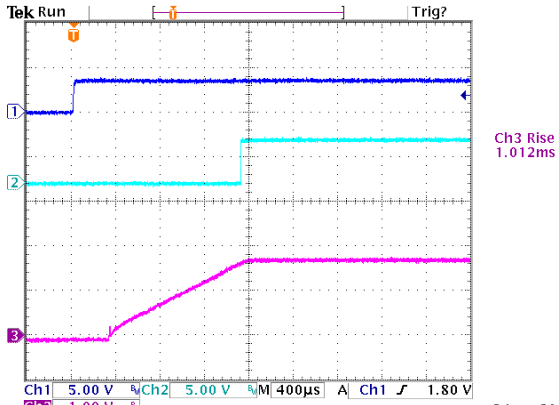

Figure 15: Turn on delay time at 12Vin, 1.8V/60A out (1mS/div)
Ch1: Enable, Ch2: PG, Ch3: Vo

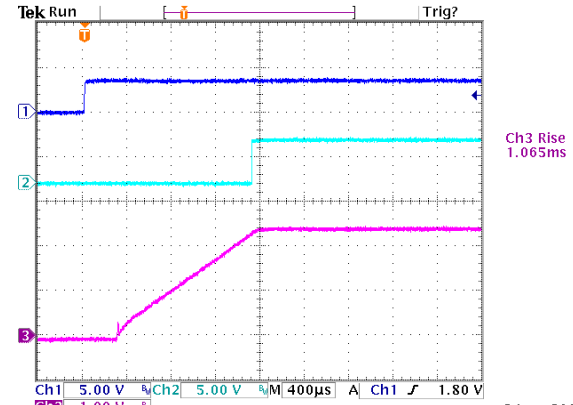

Figure 16: Turn on delay time at 12Vin, 2.5V/60A out (1mS/div)
Ch1: Enable, Ch2: PG, Ch3: Vo

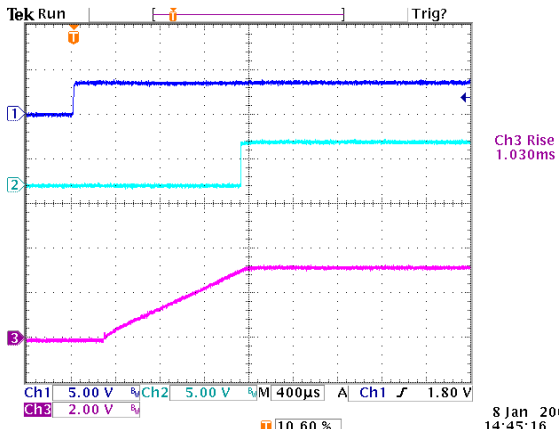

Figure 17: Turn on delay time at 12Vin, 3.3V/60A out (1mS/div)
Ch1: Enable, Ch2: PG, Ch3: Vo

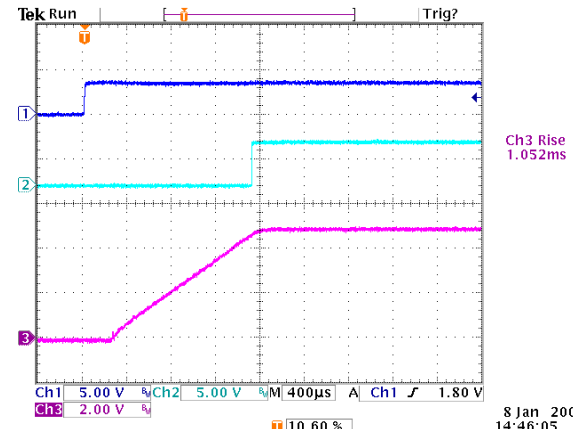

Figure 18: Turn on delay time at 12Vin, 5.0V/60A out (1mS/div)
Ch1: Enable, Ch2: PG, Ch3: Vo

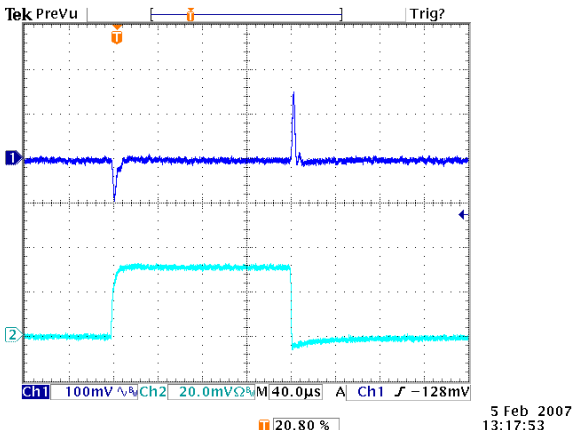

Figure 19: Typical transient response to step load change at $10A/\mu S$ from 50% to 100% and 100% to 50 of I_o , max at 12Vin, 0.9V out (0.100V/div)

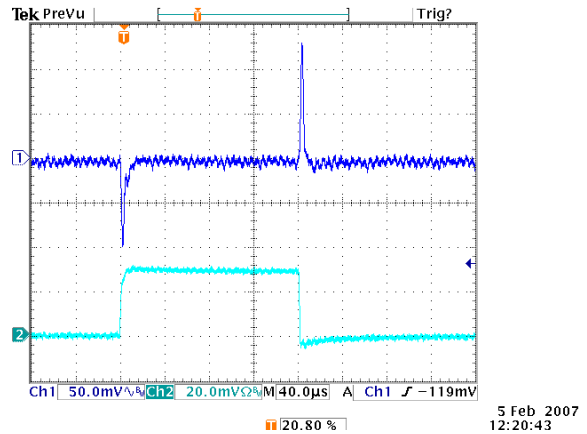

Figure 20: Typical transient response to step load change at $10A/\mu S$ from 50% to 100% and 100% to 50 of I_o , max at 12Vin, 1.2V out (0.100V/div)

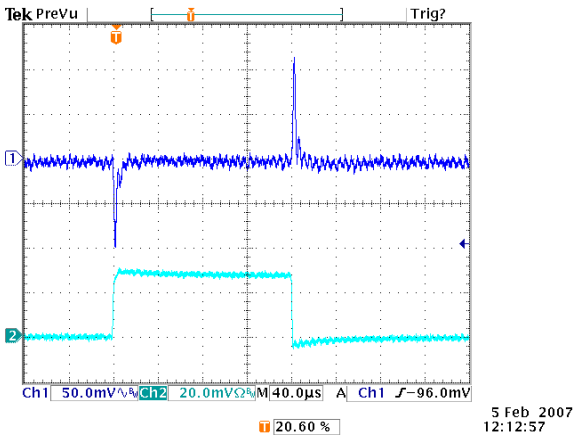

Figure 21: Typical transient response to step load change at $10A/\mu S$ from 50% to 100% and 100% to 50 of I_o , max at 12Vin, 1.8V out (0.100V/div)

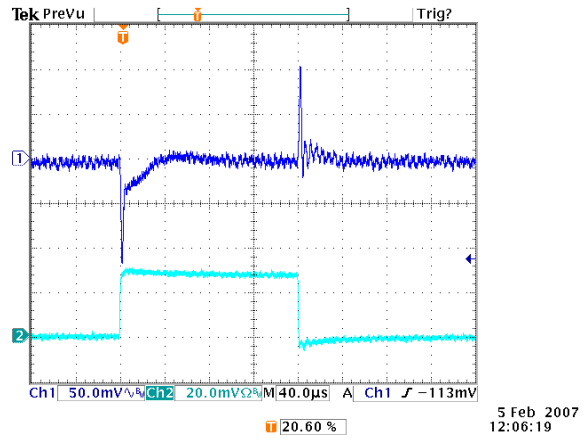

Figure 22: Typical transient response to step load change at $10A/\mu S$ from 50% to 100% and 100% to 50 of I_o , max at 12Vin, 2.5V out (0.100V/div)

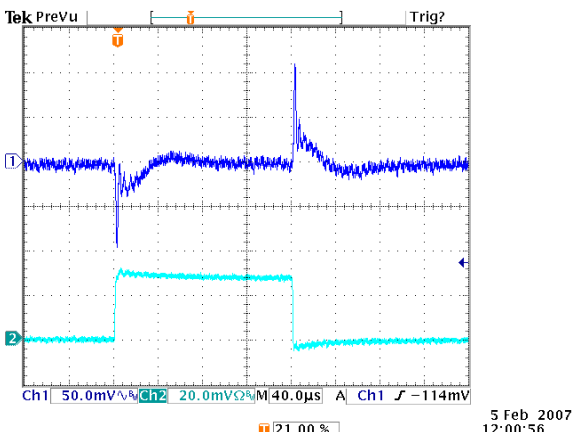

Figure 23: Typical transient response to step load change at $10A/\mu S$ from 50% to 100% and 100% to 50 of I_o , max at 12Vin, 3.3V out (0.100V/div)

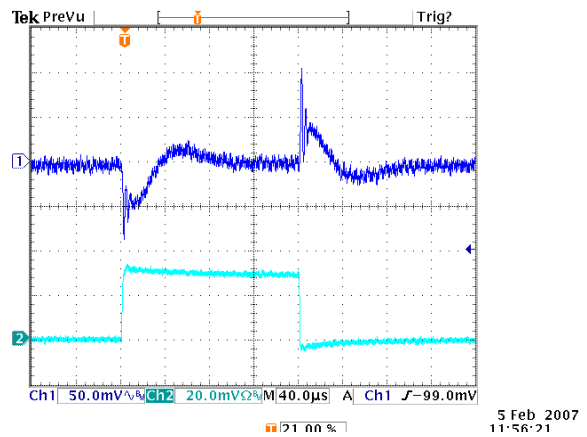

Figure 24: Typical transient response to step load change at $10A/\mu S$ from 50% to 100% and 100% to 50 of I_o , max at 12Vin, 5.0V out (0.100V/div)

DESIGN CONSIDERATIONS

The D12S300-1 uses a three phase and voltage mode controlled buck topology. The output can be trimmed in the range of 0.6Vdc to 5.0Vdc by a resistor from Trim pin to Ground.

The converter can be turned ON/OFF by remote control. Positive on/off (ENABLE pin) logic implies that the converter DC output is enabled when the signal is driven high (greater than 1.2V) or floating and disabled when the signal is driven low (below 0.7V). Negative on/off logic is optional.

The converter provides an open collector Power Good signal. The power good signal is pulled low when output is not within $\pm 10\%$ of Vout or Enable is OFF.

The converter can protect itself by entering hiccup mode against over current and short circuit condition.

Safety Considerations

It is recommended that the user to provide a fuse in the input line for safety. The output voltage set-point and the output current in the application could define the amperage rating of the fuse.

FEATURES DESCRIPTIONS

Enable (On/Off)

The ENABLE (on/off) input allows external circuitry to put the D12S300-1 converter into a low power dissipation (sleep) mode. Positive ENABLE is available as standard.

Positive ENABLE units of the D12S300-1 series are turned on if the ENABLE pin is high or floating. Pulling the pin low will turn off the unit. With the active high function, the output is guaranteed to turn on if the ENABLE pin is driven above 1.2V. The output will turn off if the ENABLE pin voltage is pulled below 0.7V.

The ENABLE input can be driven in a variety of ways as shown in Figures 25 and 26. If the ENABLE signal comes from the primary side of the circuit, the ENABLE can be driven through either a bipolar signal transistor (Figure 25). If the enable signal comes from the secondary side, then an opto-coupler or other isolation devices must be used to bring the signal across the voltage isolation (please see Figure 26).

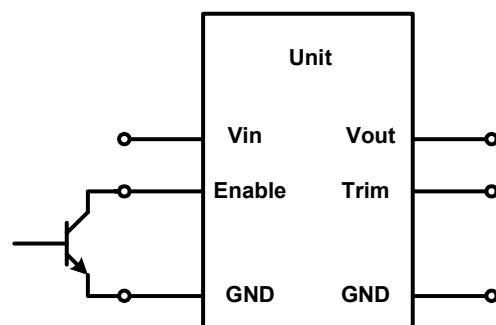

Figure 25: Enable Input drive circuit for D12S300-1 series

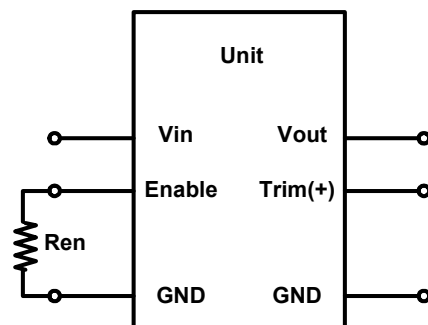

Figure 26: Enable input drive circuit example with isolation.

FEATURES DESCRIPTIONS (CON.)

Input Under-Voltage Lockout

The input under-voltage lockout prevents the converter from being damaged while operating when the input voltage is too low. The lockout occurs between 4.1V to 4.5V.

Over-Current and Short-Circuit Protection

The D12S300-1 series modules have non-latching over-current and short-circuit protection circuitry. When over current condition occurs, the module goes into the non-latching hiccup mode. When the over-current condition is removed, the module will resume normal operation.

An over current condition is detected by measuring the voltage drop across the inductor. The voltage drop across the inductor is also a function of the inductor's DCR.

Note that none of the module specifications are guaranteed when the unit is operated in an over-current condition.

Remote Sense

The D12S300-1 provides V_o remote sensing to achieve proper regulation at the load points and reduce effects of distribution losses on output line. In the event of an open remote sense line, the module shall maintain local sense regulation through an internal resistor. The module shall correct for a total of 0.6V of loss. The remote sense connects as shown in Figures 27.

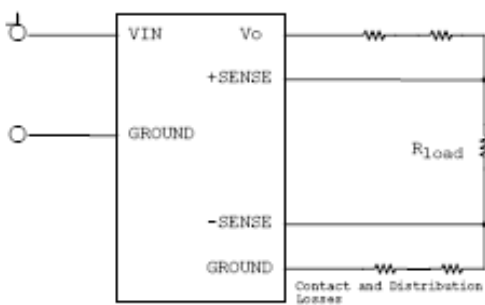

Figure 27 : Circuit configuration for remote sense

Output Voltage Programming

The output voltage of the NE series is trimmable by connecting an external resistor between the trim pin and output ground as shown Figure 28 and the typical trim resistor values are shown in Table 1.

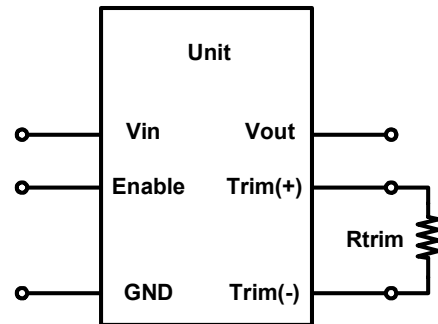

Figure 28: Trimming Output Voltage

The D12S300-1 module has a trim range of 0.6V to 5.0V. The trim resistor equation for the D12S300-1 is:

$$R_s(\Omega) = \frac{1200}{V_{out} - 0.6}$$

V_{out} is the output voltage setpoint
 R_s is the resistance between Trim and Ground
 R_s values should not be less than 270 Ω

Output Voltage	R_s (Ω)
0.6V	open
+0.9V	4K
+1.2V	2K
+1.5 V	1.33K
+1.8V	1K
+2.5 V	631.6
+3.3 V	444.4
+5.0V	272.7

Table 1: Typical trim resistor values

Power Good

The converter provides an open collector signal called Power Good. This output pin uses positive logic and is open collector. This power good output is able to sink 5mA and set high when the power is within $\pm 10\%$ of output set point. The power good signal is pulled low when output is not within $\pm 10\%$ of V_{out} or Enable is OFF.

FEATURES DESCRIPTIONS (CON.)

Voltage Margining Adjustment

Output voltage margin adjusting can be implemented in the ND modules by connecting a resistor, $R_{\text{margin-up}}$, from the Trim pin to the Ground for margining up the output voltage. Also, the output voltage can be adjusted lower by connecting a resistor, $R_{\text{margin-down}}$, from the Trim pin to the voltage source V_t . Figure 29 shows the circuit configuration for output voltage margining adjustment.

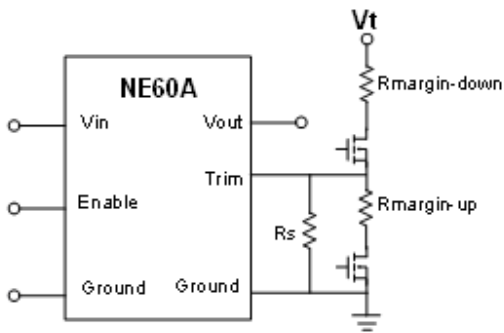

Figure 29: Circuit configuration for output voltage margining

Output Capacitance

There are internal output capacitors on the D12S300-1 series modules. Hence, no external output capacitor is required for stable operation.

Reflected Ripple Current and Output Ripple and Noise Measurement

The measurement set-up outlined in Figure 30 has been used for both input reflected/ terminal ripple current and output voltage ripple and noise measurements on D12S300-1 series converters.

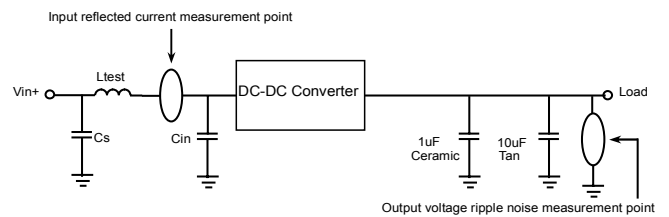

$C_s=330\mu\text{F OS-CON cap x 1}$, $L_{\text{test}}=1\mu\text{H}$, $C_{in}=330\mu\text{F OS-CON cap x 1}$

Figure 30: Input reflected ripple/ capacitor ripple current and output voltage ripple and noise measurement setup for D12S300-1



THERMAL CONSIDERATION

Thermal management is an important part of the system design. To ensure proper, reliable operation, sufficient cooling of the power module is needed over the entire temperature range of the module. Convection cooling is usually the dominant mode of heat transfer.

Hence, the choice of equipment to characterize the thermal performance of the power module is a wind tunnel.

Thermal Testing Setup

Delta's DC/DC power modules are characterized in heated vertical wind tunnels that simulate the thermal environments encountered in most electronics equipment. This type of equipment commonly uses vertically mounted circuit cards in cabinet racks in which the power modules are mounted.

The following figure shows the wind tunnel characterization setup. The power module is mounted on a test PWB and is vertically positioned within the wind tunnel. The space between the neighboring PWB and the top of the power module is constantly kept at 6.35mm (0.25").

Thermal Derating

Heat can be removed by increasing airflow over the module. To enhance system reliability, the power module should always be operated below the maximum operating temperature. If the temperature exceeds the maximum module temperature, reliability of the unit may be affected.

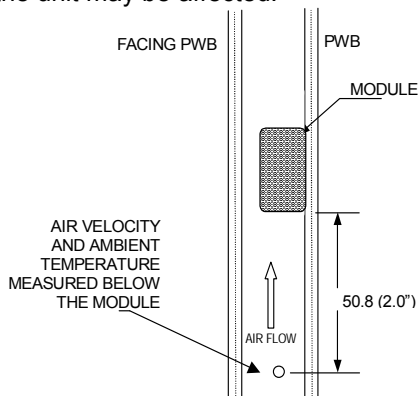

Note: Wind Tunnel Test Setup Figure Dimensions are in millimeters and (Inches)

Figure 31: Wind tunnel test setup

THERMAL CURVES (D12S300-1)

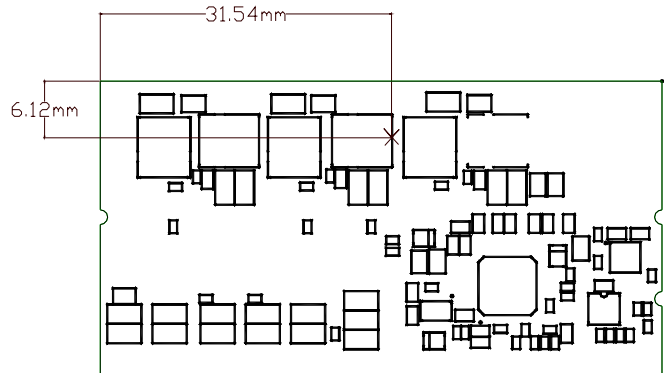

Figure 32: Temperature measurement location* The allowed maximum hot spot temperature is defined at 115

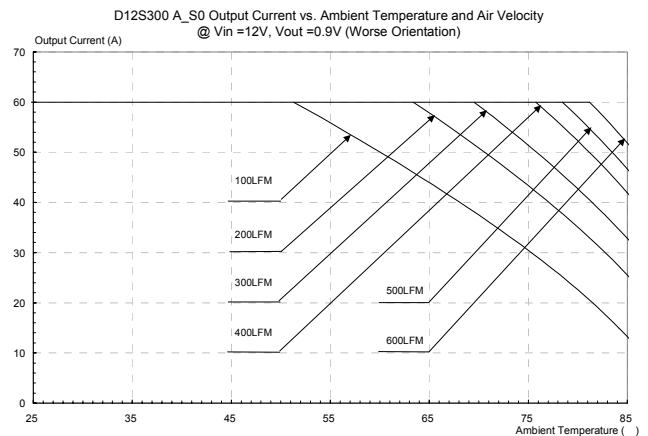

Figure 33: Output current vs. ambient temperature and air velocity @ Vin=12V, Vout=0.9V (Worse Orientation)

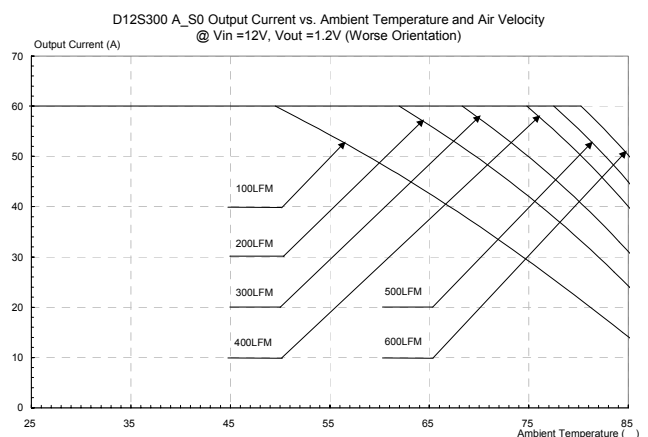

Figure 34: Output current vs. ambient temperature and air velocity @ Vin=12V, Vout=1.2V (Worse Orientation)



THERMAL CURVES (D12S300-1)

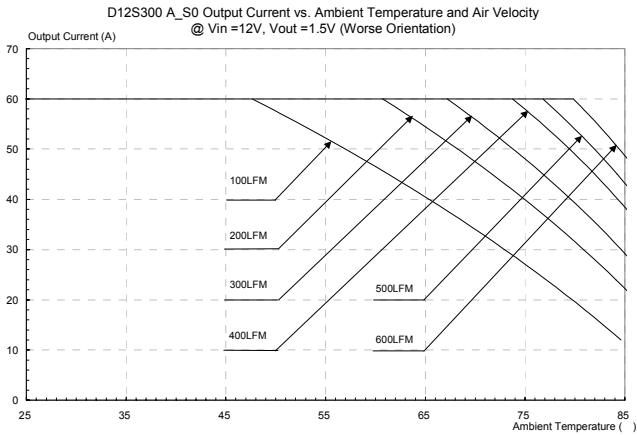

Figure 35: Output current vs. ambient temperature and air velocity @ $V_{in}=12V$, $V_{out}=1.5V$ (Worse Orientation)

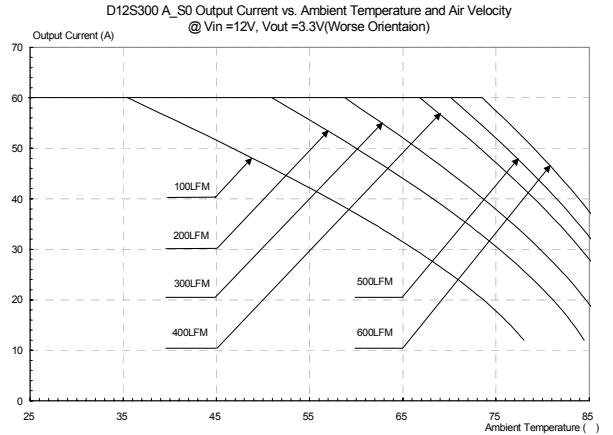

Figure 38: Output current vs. ambient temperature and air velocity @ $V_{in}=12V$, $V_{out}=3.3V$ (Worse Orientation)

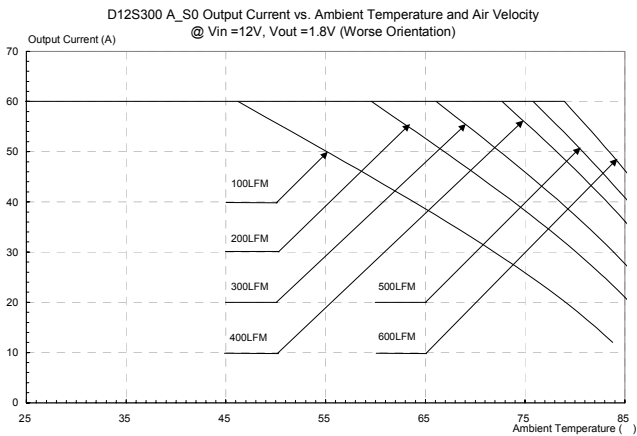

Figure 36: Output current vs. ambient temperature and air velocity @ $V_{in}=12V$, $V_{out}=1.8V$ (Worse Orientation)

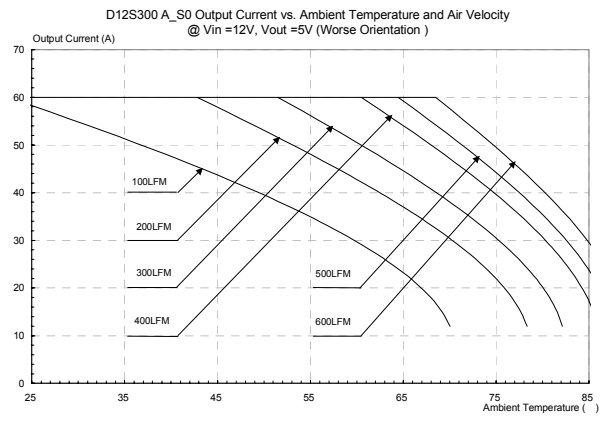

Figure 39: Output current vs. ambient temperature and air velocity @ $V_{in}=12V$, $V_{out}=5V$ (Worse Orientation)

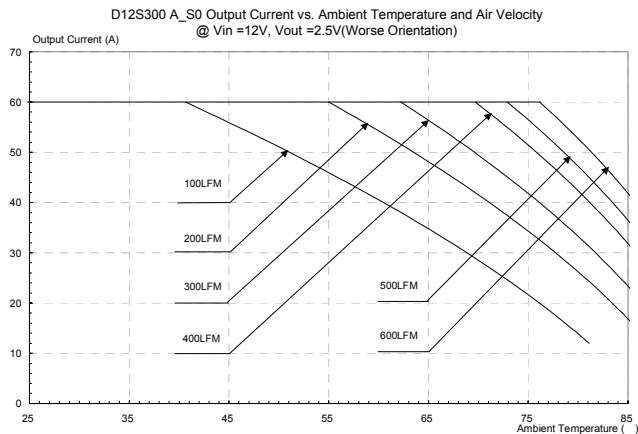

Figure 37: Output current vs. ambient temperature and air velocity @ $V_{in}=12V$, $V_{out}=2.5V$ (Worse Orientation)





MECHANICAL DRAWING

VERTICAL

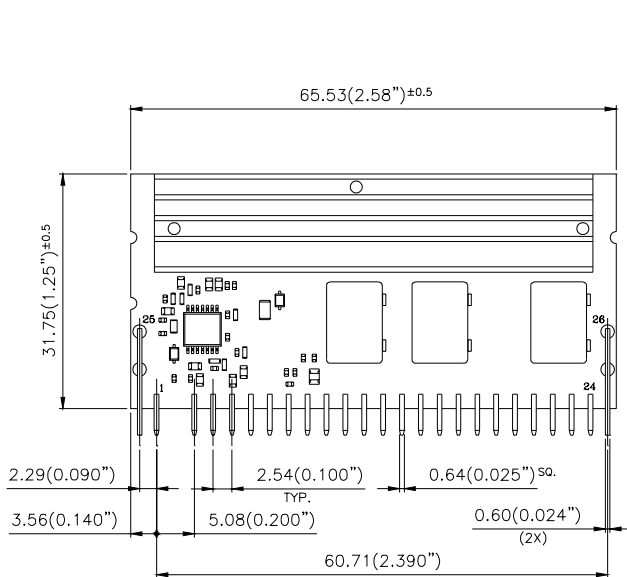

FRONT VIEW

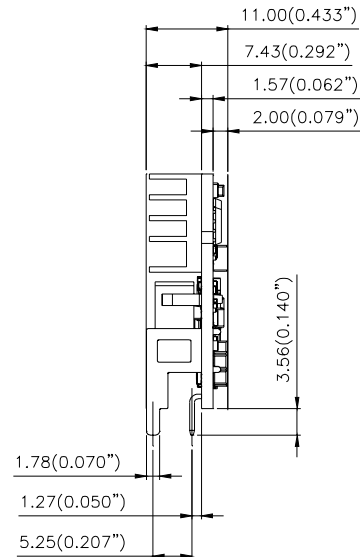

SIDE VIEW

PIN#	Function	PIN#	Function
1	TRIM +	14	Vin
2	OMIT (KEY)	15	Vout
3	GROUND	16	Vout
4	POWER GOOD	17	GROUND
5	TRIM -	18	Vout
6	ISHARE	19	GROUND
7	GROUND	20	Vout
8	GROUND	21	GROUND
9	ENABLE	22	Vout
10	REM SENSE (-)	23	GROUND
11	REM SENSE (+)	24	Vout
12	Vin	25	MECH SUPPORT
13	Vin	26	MECH SUPPORT

NOTES:
 DIMENSIONS ARE IN MILLIMETERS AND (INCHES)
 TOLERANCES: X.Xmm±0.50mm(X.XX in.±0.020 in.)
 X.XXmm±0.25mm(X.XXX in.±0.010 in.)

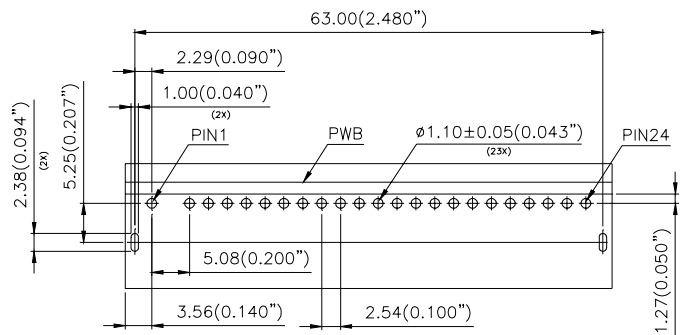

RECOMMENDED P.W.B LAYOUT



PART NUMBERING SYSTEM

D	12	S	300	-1 B/C
Type of Product	Input Voltage	Number of Outputs	Product Series	Option Code
D - DC/DC modules	12- 4.5~13.8V	S - Single Output	300 - 300W/60A	1B : 4.55mm 1C : 3.56mm

MODEL LIST

Model Name	Packaging	Input Voltage	Output Voltage	Output Current	Efficiency 12Vin, 5Vout @ 100% load
D12S300-1 C	Vertical	4.5 ~ 13.8Vdc	0.6 V~5.0Vdc	60A	94%
D12S300-1 B	Vertical	4.5 ~ 13.8Vdc	0.6 V~5.0Vdc	60A	94%

CONTACT: www.delta.com.tw/dcdc

USA:

Telephone:
East Coast: (888) 335 8201
West Coast: (888) 335 8208
Fax: (978) 656 3964
Email: DCDC@delta-corp.com

Europe:

Telephone: +41 31 998 53 11
Fax: +41 31 998 53 53
Email: DCDC@delta-es.tw

Asia & the rest of world:

Telephone: +886 3 4526107 ext. 6220
Fax: +886 3 4513485
Email: DCDC@delta.com.tw

WARRANTY

Delta offers a two (2) year limited warranty. Complete warranty information is listed on our web site or is available upon request from Delta.

Information furnished by Delta is believed to be accurate and reliable. However, no responsibility is assumed by Delta for its use, nor for any infringements of patents or other rights of third parties, which may result from its use. No license is granted by implication or otherwise under any patent or patent rights of Delta. Delta reserves the right to revise these specifications at any time, without notice.