

Wireless Accelerometer - Vibration Meters

General Description

The ALTA Wireless Vibration Meter Sensor uses an accelerometer to measure vibration speed and frequency and report on 3 axes. The sensor reports speed (mm/s) and frequency (Hz) on all three axes, and duty cycle (how much of the report interval vibration was present).

Features

- Three axis measurement
- Reports critical vibration and frequency data
- Runtime indication via duty cycle

Principle of Operation

The ALTA Vibration Meter measures the vibration intensity of the system to which it is attached. The sensor uses an accelerometer to capture g-force on all axes and then calculates speed and frequency from that acceleration data. The Vibration Meter reports the duty cycle, or how long the sensor was measuring vibrations throughout the heartbeat.

Example Applications

- Vibration monitoring
- Smart machines, smart structures & smart materials
- Bridge and building seismic activity monitoring
- Assembly line monitoring
- Many additional applications

Features of Monnit ALTA Sensors

- Wireless range of 1,200+ feet through 12+ walls *
- Frequency-Hopping Spread Spectrum (FHSS)
- Improved interference immunity
- Improved power management for longer battery life ** (12+ years on AA batteries)
- Encrypt-RF[®] Security (Diffie-Hellman Key Exchange + AES-128 CBC for sensor data messages)
- All ALTA sensors now have up to 3200 readings:
 - 10-minute heartbeats = 22 days
 - 2-hour heartbeats = 266 days
- Over-the-air updates (future proof)
- Free iMonnit basic online wireless sensor monitoring and notification system to configure sensors, view data and set alerts via SMS text and email

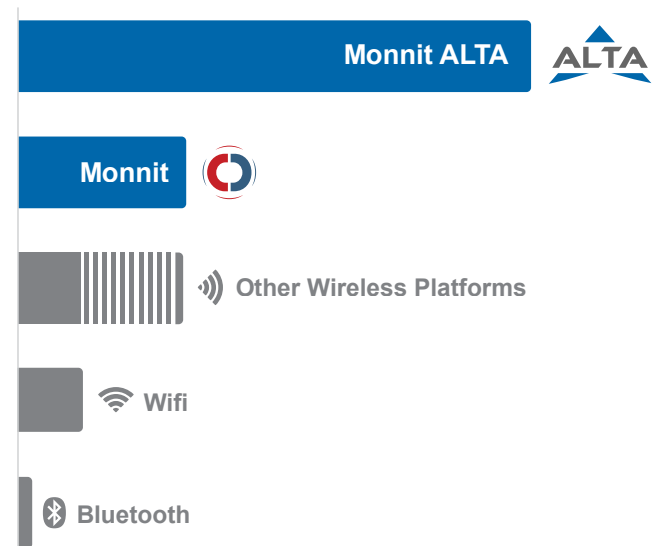

- * Actual range may vary depending on environment.
- ** Battery life is determined by sensor reporting frequency and other variables. Other power options are also available.

Wireless Range Comparison

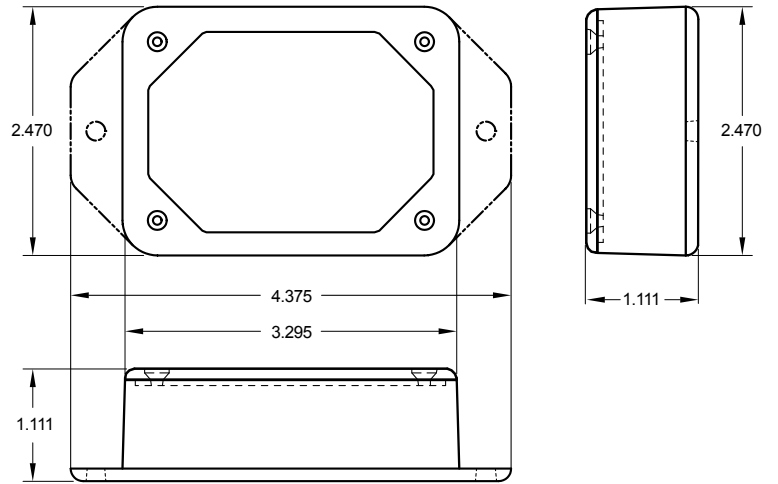



ALTA Commercial AA Wireless Accelerometer - Vibration Meter | Technical Specifications

| | |
|---|---|
| Supply voltage | 2.0–3.8 VDC (3.0–3.8 VDC using power supply) * |
| Current consumption | 0.2 μ A (sleep mode), 0.7 μ A (RTC sleep), 570 μ A (MCU idle), 2.5 mA (MCU active), 5.5 mA (radio RX mode), 22.6 mA (radio TX mode) |
| Operating temperature range (board circuitry and batteries) | -18°C to 55°C (0°F to 130°F) using alkaline -40°C to 85°C (-40°F to 185°F) using lithium ** |
| Optimal battery temperature range (AA) | +10°C to +50°C (+50°F to +122°F) |
| Speed measurement range | 0 to 25.5 mm/s |
| Speed measurement resolution | 0.1 mm/s |
| Frequency measurement range | 10 to 200 Hz |
| Frequency measurement resolution | 1 Hz |
| Vibration intensity threshold range | 0 to 1.701 g |
| Vibration intensity threshold resolution | 0.063 g |
| Accelerometer g-Force Range | +/- 2 g |
| Integrated memory | Up to 3200 sensor messages |
| Wireless range | 1,200+ ft non-line-of-sight |
| Security | Encrypt-RF® (256-bit key exchange and AES-128 CTR) |
| Weight | 3.7 ounces |
| Certifications | <div style="display: flex; align-items: center; gap: 10px;">    Industry Canada </div> 900 MHz product; FCC ID: ZTL-G2SC1 and IC: 9794A-G2SC1. 868 and 433 MHz product tested and found to comply with: EN 300 220-2 V3.1.1 (2017-02), EN 300 220-2 V3.1.1 (2017-02) and EN 60950 |

* Hardware cannot withstand negative voltage. Please take care when connecting a power device.

** At temperatures above 100°C, it is possible for the board circuitry to lose programmed memory.

Power Options

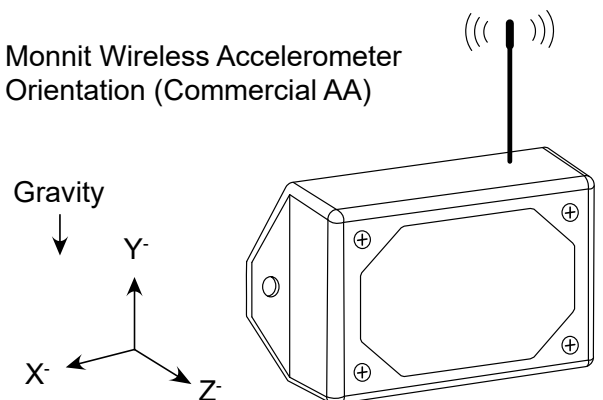

The standard version of this sensor is powered by two replaceable 1.5 V AA sized batteries (included with purchase). This sensor is also available with a line power option. The line powered version of this sensor has a barrel power connector allowing it to be powered by a standard 3.0–3.6 V power supply. The line powered version also uses two standard 1.5 V AA batteries as backup for uninterrupted operation in the event of line power outage. Power options must be selected at time of purchase, as the internal hardware of the sensor must be changed to support the selected power requirements.

Monnit Wireless Accelerometer Orientation (Commercial AA)

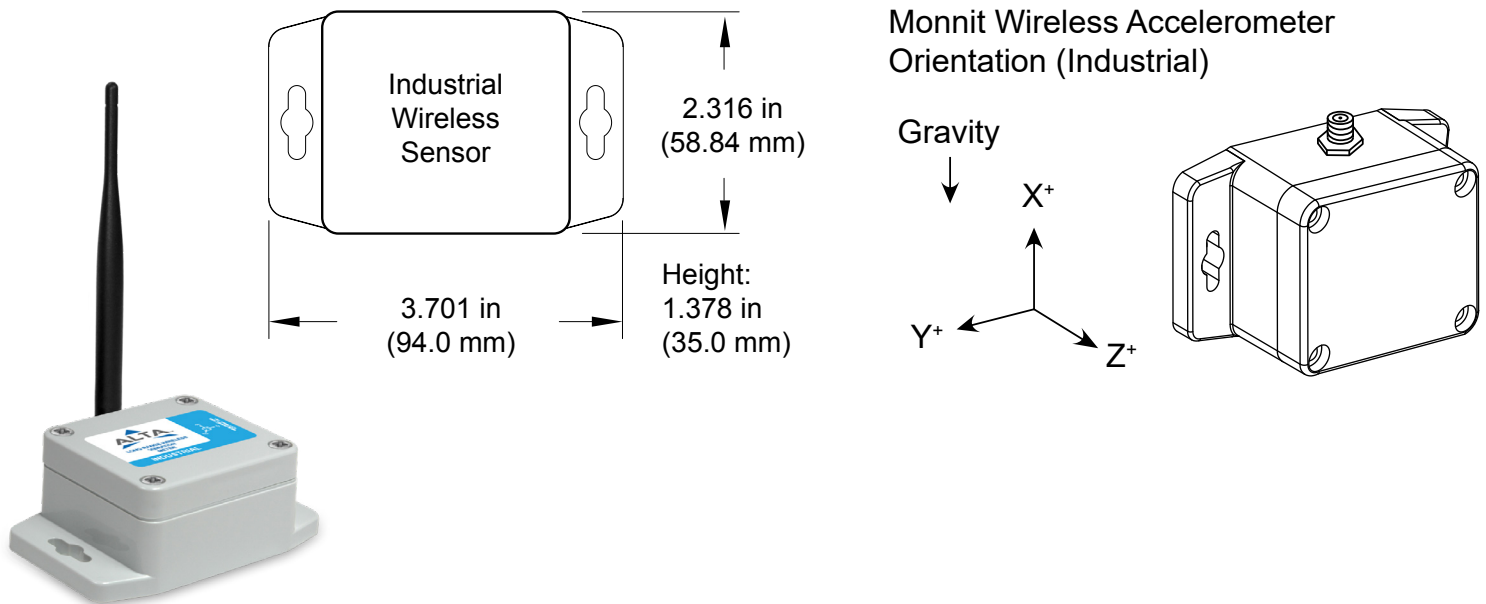



ALTA Industrial Wireless Accelerometer - Vibration Meter | Technical Specifications

| | | |
|---|---|--|
| Supply voltage | 2.0–3.8 VDC (3.0–3.8 VDC using power supply) * | |
| Current consumption | 0.2 μ A (sleep mode), 0.7 μ A (RTC sleep), 570 μ A (MCU idle), 2.5 mA (MCU active), 5.5 mA (radio RX mode), 22.6 mA (radio TX mode) | |
| Operating temperature range (board circuitry and battery) | -40°C to +85°C (-40°F to +185°F) ** | |
| Included battery | Max Temperature Range | -40° to +85°C (-40° to +185°F) |
| | Capacity | 1500 mAh |
| Optional solar feature | Solar panel | 5VDC/30mA (53mm x 30mm) |
| | Charging temperature range | 0° to 45°C (32° to 113°F) |
| | Max temperature range | -20° to 60°C (-4° to 140°F) |
| | Included rechargeable battery | 600 mAh / >2000 charge cycles (80% of initial capacity) |
| | Solar efficiency | Optimized for high and low-light operation *** |
| Speed measurement range | 0 to 25.5 mm/s | |
| Speed measurement resolution | 0.1 mm/s | |
| Frequency measurement range | 10 to 200 Hz | |
| Frequency measurement resolution | 1 Hz | |
| Vibration intensity threshold range | 0 to 1.701 g | |
| Vibration intensity threshold resolution | 0.063 g | |
| Accelerometer g-Force Range | +/- 2 g | |
| Integrated memory | Up to 3200 sensor messages | |
| Wireless range | 1,200+ ft non-line-of-sight | |
| Security | Encrypt-RF™ (256-bit key exchange and AES-128 CTR) | |
| Weight | 4.7 ounces | |
| Enclosure rating | NEMA 1, 2, 4, 4x, 12 and 13 rated, sealed and weather proof | |
| UL Rating | UL Listed to UL508-4x specifications (File E194432) | |
| Certifications |    Industry Canada | 900 MHz product; FCC ID: ZTL-G2SC1 and IC: 9794A-G2SC1. 868 and 433 MHz product tested and found to comply with: EN 300 220-2 V3.1.1 (2017-02), EN 300 220-2 V3.1.1 (2017-02) and EN 60950 |

* Hardware cannot withstand negative voltage. Please take care when connecting a power device.

** At temperatures above 100°C, it is possible for the board circuitry to lose programmed memory.

*** Light present 25% of day yields 125% of operating power to support 10-minute heartbeats.

Commercial Grade Sensors

Monnit commercial grade sensors are designed for applications in ordinary environments (normal room temperature, humidity and atmospheric pressure). Do not use these sensors under the following conditions as these factors can deteriorate the product characteristics and cause failures and burnout.

- Corrosive gas or deoxidizing gas: chlorine gas, hydrogen sulfide gas, ammonia gas, sulfuric acid gas, nitric oxides gas, etc.
- Volatile or flammable gas
- Dusty conditions
- Low-pressure or high-pressure environments
- Wet or excessively humid locations
- Places with salt water, oils chemical liquids or organic solvents
- Where there are excessively strong vibrations
- Other places where similar hazardous conditions exist

Use these products within the specified temperature range. Higher temperature may cause deterioration of the characteristics or the material quality.

Industrial Grade Sensors | Type 1, 2, 4, 4X, 12 and 13 NEMA Rated Enclosure

Monnit's Industrial sensors are enclosed in reliable, weatherproof NEMA-rated enclosures. Our NEMA-rated enclosures are constructed for both indoor or outdoor use and protect the sensor circuitry against the ingress of solid foreign objects like dust as well as the damaging effects of water (rain, sleet, snow, splashing water, and hose-directed water).

- Safe from falling dirt
- Protects against wind-blown dust
- Protects against rain, sleet, snow, splashing water, and hose-directed water
- Increased level of corrosion resistance
- Will remain undamaged by ice formation on the enclosure



For more information about our products or to place an order, please contact our sales department at 801-561-5555.

Visit us on the web at www.monnit.com.

Monnit Corporation
3400 South West Temple
Salt Lake City, UT 84115
801-561-5555
www.monnit.com