

# Breakover Diode Gen<sup>1</sup> (BOD1)

$V_{BO} = 600-1000\text{ V}$   
 $I_{AVM} = 0.9\text{ A}$

$V_{BO}$ [V]	Standard Types
600 ±50	IXBOD1-06
700 ±50	IXBOD1-07
800 ±50	IXBOD1-08
900 ±50	IXBOD1-09
1000 ±50	IXBOD1-10

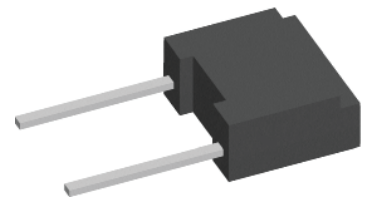

Backside: isolated



### Features / Advantages:

- Very low forward voltage drop
- Low leakage current

### Applications:

- High voltage circuit protection
- Transient voltage protection
- Trigger device
- Power pulse generators
- Lightning and arcing protection
- Energy discharge circuits
- Battery overvoltage protection
- Solar array protection

### Package: FP-Case

- Industry standard outline
- RoHS compliant
- Epoxy meets UL 94V-0
- Soldering pins for PCB mounting
- Base plate: Plastic overmolded tab
- Reduced weight

BOD1			Ratings			
Symbol	Definitions	Conditions	min.	typ.	max.	
$I_D$	drain current	$V_D = 0.8 \cdot V_{BO}$ $T_{VJ} = 125^\circ\text{C}$			20	$\mu\text{A}$
$V_{BO}$	breakover voltage	$V_{BO}(T_{VJ}) = V_{BO,25^\circ\text{C}} [1 + K_T (T_{VJ} - 25^\circ\text{C})]$				V
$I_{RMS}$	RMS current	$f = 50 \text{ Hz}$ $T_{amb} = 50^\circ\text{C}$ pins soldered to printed circuit (conductor 0.035x2mm)			1.4	A
$I_{FAVM}$	maximum average forward current				0.9	A
$I_{SM}$	maximum pulsed source current	$t_p = 0.1 \text{ ms}$ ; non repetitive $T_{amb} = 50^\circ\text{C}$			200	A
$I^2t$	$I^2t$ value for fusing	$t_p = 0.1 \text{ ms}$ $T_{amb} = 50^\circ\text{C}$			2	$\text{A}^2\text{s}$
$K_T$	temperature coefficient of $V_{BO}$				$2 \cdot 10^{-3}$	$\text{K}^{-1}$
$K_P$	coefficient for energy per pulse EP (material constant)				700	K/Ws
$R_{thJA}$	thermal resistance junction to ambient	natural convection with air speed 2 m/s			60 45	K/W K/W
$I_{BO}$	breakover current				15	mA
$I_H$	holding current				30	mA
$V_H$	holding voltage		4		8	V
$(dv/dt)_{cr}$	critical rate of rise of voltage	$V_D = 0.67 \cdot (V_{BO} + 100 \text{ V})$ $T_{VJ} = 50^\circ\text{C}$			1000	$\text{V}/\mu\text{s}$
$(di/dt)_{cr}$	critical rate of rise of current	$V_D = V_{BO}$ ; $I_T = 80 \text{ A}$ ; $f = 50 \text{ Hz}$ $T_{VJ} = 125^\circ\text{C}$			200	$\text{A}/\mu\text{s}$
$t_q$	turn-off time	$V_D = 0.67 \cdot V_{BO}$ ; $V_R = 0 \text{ V}$ ; $I_T = 80 \text{ A}$ $T_{VJ} = 125^\circ\text{C}$ $dv/dt_{(lin.)} = 200 \text{ V}/\mu\text{s}$ ; $di/dt = -10 \text{ A}/\mu\text{s}$		150		$\mu\text{s}$
$V_T$	forward voltage drop	$I_T = 5 \text{ A}$ $T_{VJ} = 125^\circ\text{C}$			1.7	V
$V_{T0}$	threshold voltage	for power-loss calculation only $T_{VJ} = 125^\circ\text{C}$			1.1	V
$r_T$	slope resistance				0.12	$\Omega$

Package FP-Case			Ratings			
Symbol	Definitions	Conditions	min.	typ.	max.	
T <sub>amb</sub>	ambient temperature (cooling medium)		-40		125	°C
T <sub>stg</sub>	storage temperature		-40		125	°C
T <sub>vJM</sub>	maximum virtual junction temperature		-40		125	°C
<b>Weight</b>				0.9		g

### Product Marking

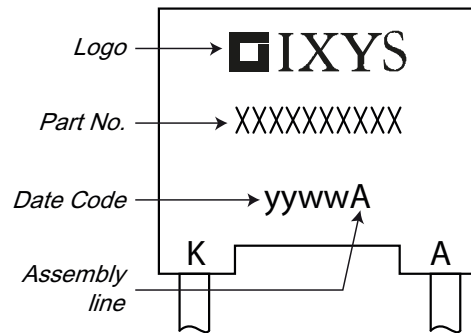

Ordering	Part Name	Marking on Product	Delivering Mode	Base Qty	Ordering Code
Standard	IXBOD1-06	IXBOD1-06	Box	100	467936
Standard	IXBOD1-07	IXBOD1-07	Box	100	478873
Standard	IXBOD1-08	IXBOD1-08	Box	100	467928
Standard	IXBOD1-09	IXBOD1-09	Box	100	474940
Standard	IXBOD1-10	IXBOD1-10	Box	100	467839

Outlines FP-case

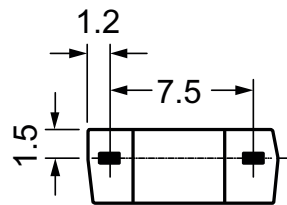
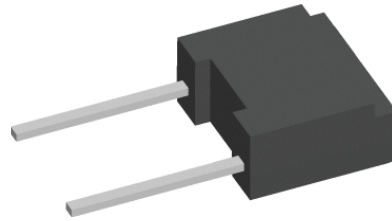

Dimensions in mm  
(1 mm = 0.0394")

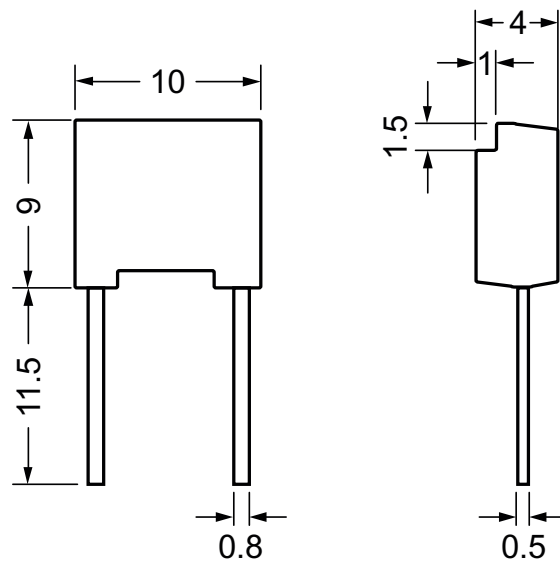

**Diode**

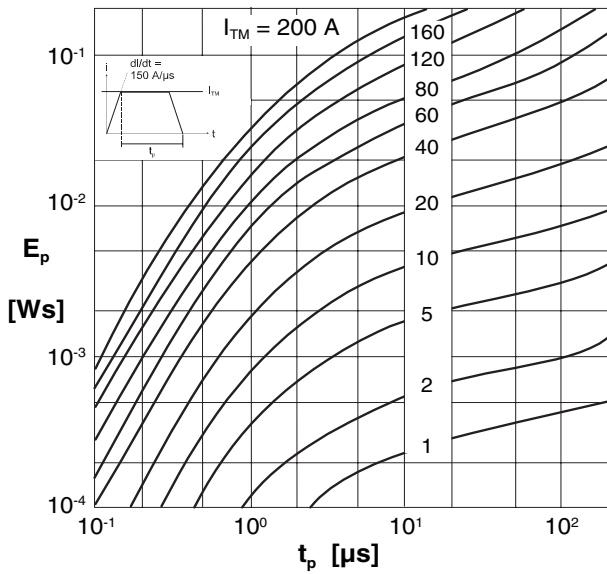

Fig. 1 Energy per pulse for trapezoidal current waveforms (see waveform definition)

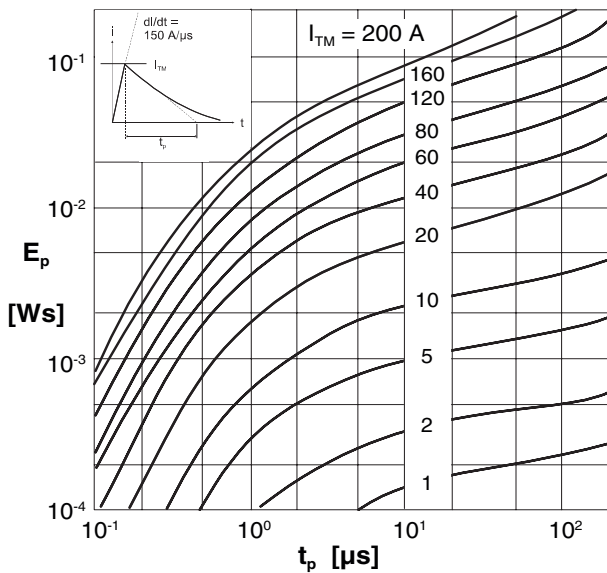

Fig. 2 Energy per pulse for exponentially decaying current pulse (see waveform definition)

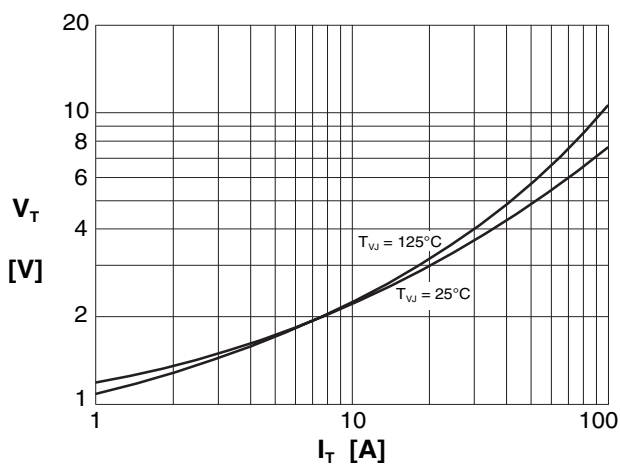

Fig. 3 On-state voltage

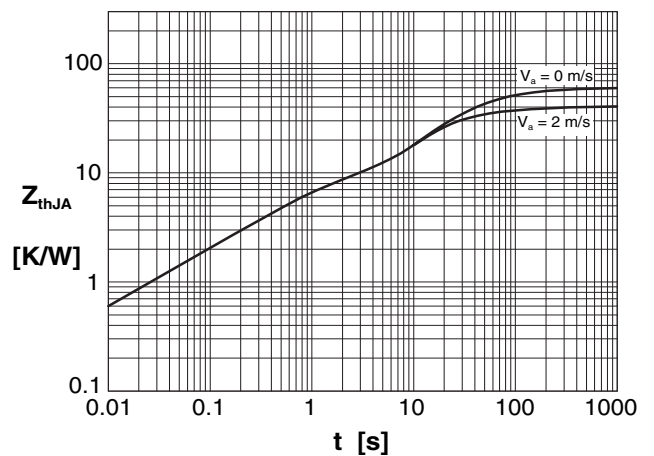

Fig. 4 Transient thermal resistance