

LOC	DIST	REVISIONS					
E	B	P	LTR	DESCRIPTION	DATE	DWN	APVD
			BA	NEW RELEASE	23-Sep-08	SM	St.P

FOR FURTHER INFORMATION SEE DATA SHEET FOR  
CPF SERIES-THIN FILM PRECISION CHIP RESISTORS

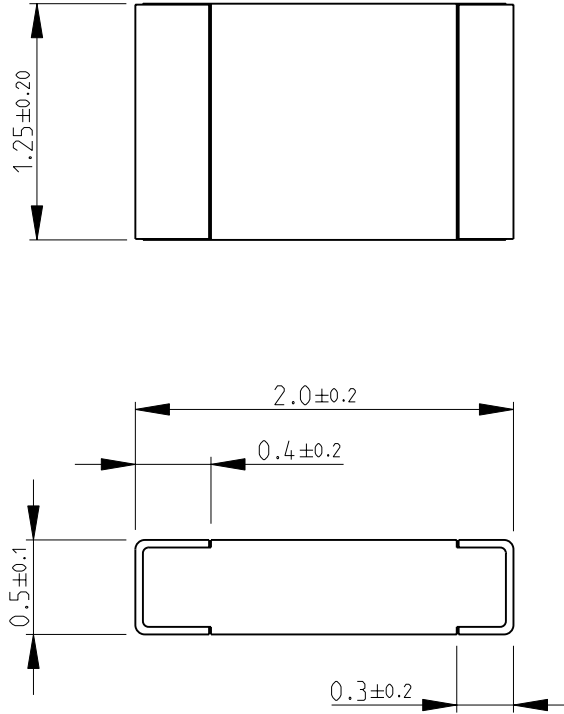

RoHS Compliant

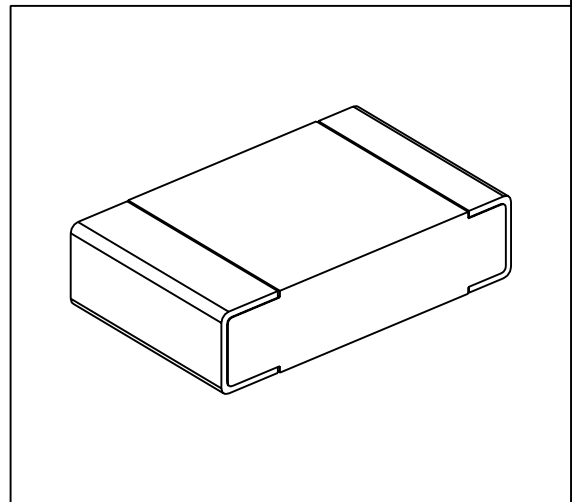

2008

RELEASED FOR PUBLICATION

THIS DRAWING IS UNPUBLISHED.

BY TYCO ELECTRONICS CORPORATION. ALL RIGHTS RESERVED.



DIMENSIONS: mm	DWN	23-Sep-08	MATERIAL	-	FINISH	-
	CHK	23-Sep-08	Tyco Electronics Corporation Dorcan, Swindon, SN3 5HH			
TOLERANCES UNLESS OTHERWISE SPECIFIED:	APVD	23-Sep-08				
0 PLC ±0.2	STEPHEN.P		NAME THIN FILM PRECISION CHIP RESISTORS SERIES CPF 0805			
1 PLC ±0.1	PRODUCT SPEC	-				
2 PLC ±	APPLICATION SPEC	-	SIZE	CAGE CODE	DRAWING NO	RESTRICTED TO
3 PLC ±			A 4	00779	© = 1614917	-
4 PLC ±	WEIGHT	-	CUSTOMER DRAWING			
ANGLES ±5°			SCALE	25:1	SHEET	1 OF 1
						REV BA