

THIS DRAWING IS UNPUBLISHED. RELEASED FOR PUBLICATION 2011
 © COPYRIGHT 2011 ALL RIGHTS RESERVED.

LOC		DIST		REVISIONS			
P	LTR	DESCRIPTION		DATE	DWN	APVD	
4		REVISED		02MAY2013	KR	JC	
5		UPDATED		22JUL2013	MZ	JC	
A		PARTS RELEASED FOR PRODUCTION		13NOV2013	MZ	JC	
B		ECR-15-011011		27JUL2015	RS	PO	

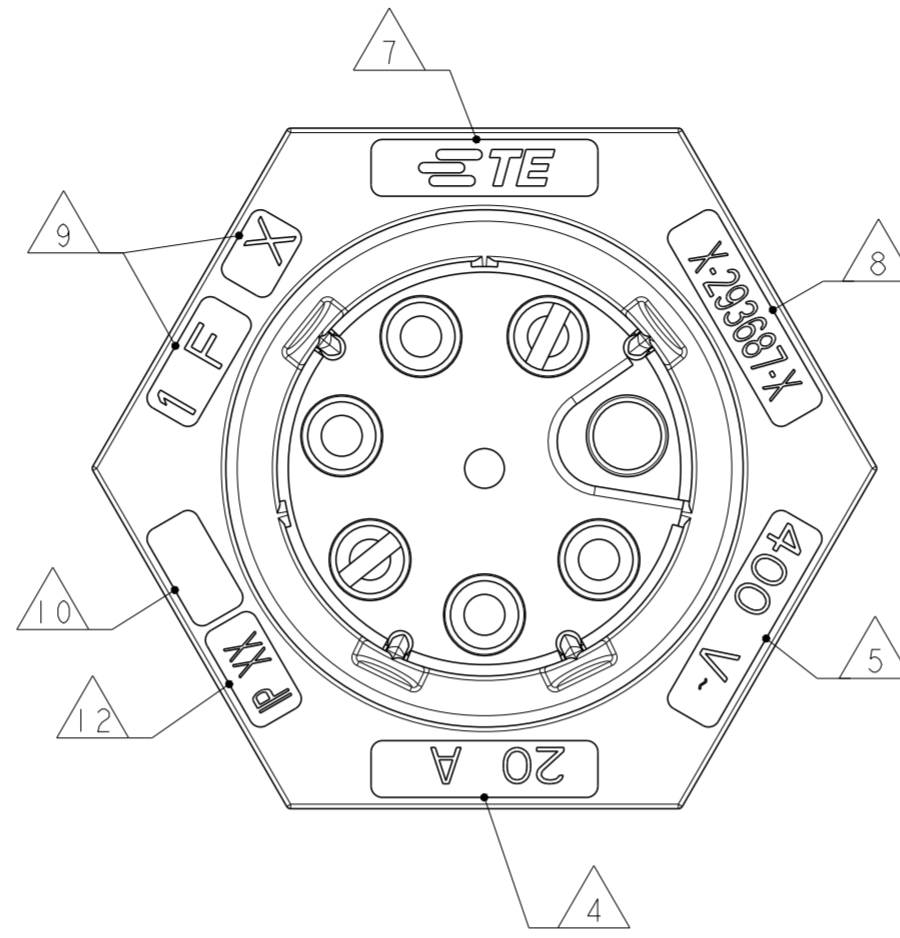

- NOTES:
- 1 MATERIAL: PA GF (NATURAL AND BLACK COLOUR)
 - 2 ALL POLARIZATION KEYS SHOWN FOR REF ONLY
 - 3 WAYS I.D.
 - 4 CURRENT RATING
 - 5 VOLTAGE RATING
 - 6 RIB CLOSING CAVITIES BY CHANGE OVER
 - 7 TE LOGO
 - 8 TE PART NUMBER
 - 9 DATA CODE AND CAVITY I.D.
 - 10 AREA FOR AGENCIES APPROVAL LOGO
- 1) SEE C-DRAWING 293682 (LOCKING CAP) TO GET IP 40
- 12 IP CODE
 - 13 POLARISATION KEY "TYPE D" SUITABLE FOR DALI APPLICATION
 - 14 SLOTS TO ALLOW DELATCHING TOOL OPERATION. FOR DELATCHING TOOL AND OPERATION REFER TO APPLICATION SPECIFICATION



THIS DRAWING IS A CONTROLLED DOCUMENT.		DWN M. ZUCCA 01APR2011	TE Connectivity	
DIMENSIONS: mm		CHK M. ZUCCA 01APR2011		
TOLERANCES UNLESS OTHERWISE SPECIFIED:		APVD G. TURCO 01APR2011	NAME SOCKET HOUSING PANEL MOUNT NECTOR* M-LINE 5 POLES UNSEALED VERSION	
0 PLC ± 1 PLC ±0.3 2 PLC ±0.20 3 PLC ± 4 PLC ± ANGLES ±3° FINISH		PRODUCT SPEC -	SIZE A20779	CAGE CODE C-293687
MATERIAL -		APPLICATION SPEC -	DRAWING NO -	RESTRICTED TO -
		WEIGHT -	SCALE 3:1	SHEET 1 OF 3
		Customer Drawing	REV B	

THIS DRAWING IS UNPUBLISHED. RELEASED FOR PUBLICATION 2011
 © COPYRIGHT 2011 ALL RIGHTS RESERVED.

LOC	DIST	REVISIONS			
P	LTR	DESCRIPTION	DATE	DWN	APVD
-	-	SEE SHEET 1	-	-	-

POLARIZATION TYPES

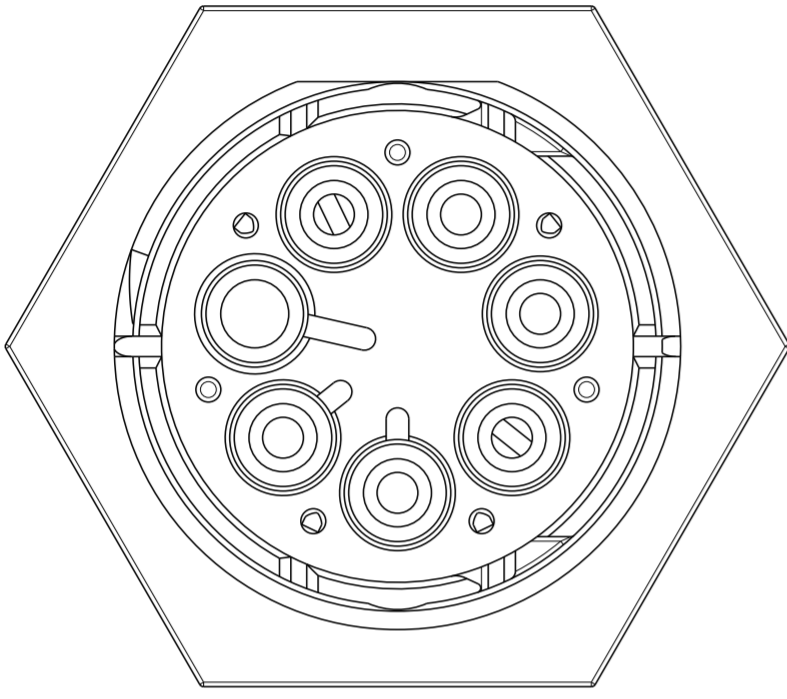
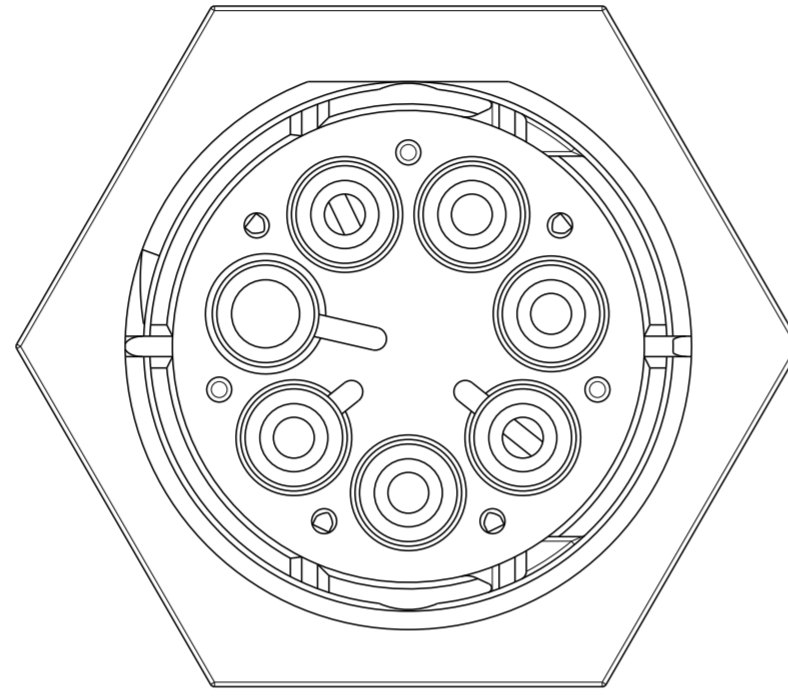
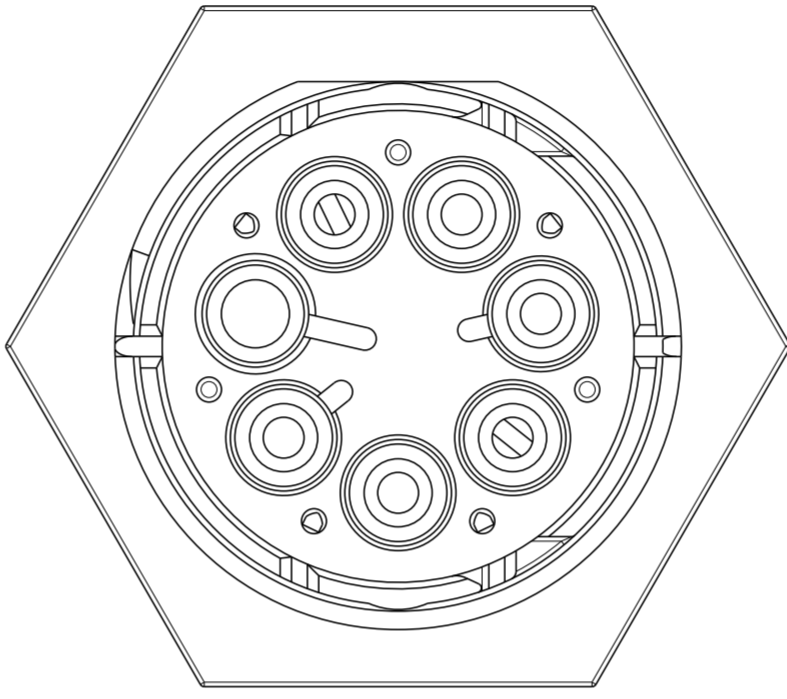
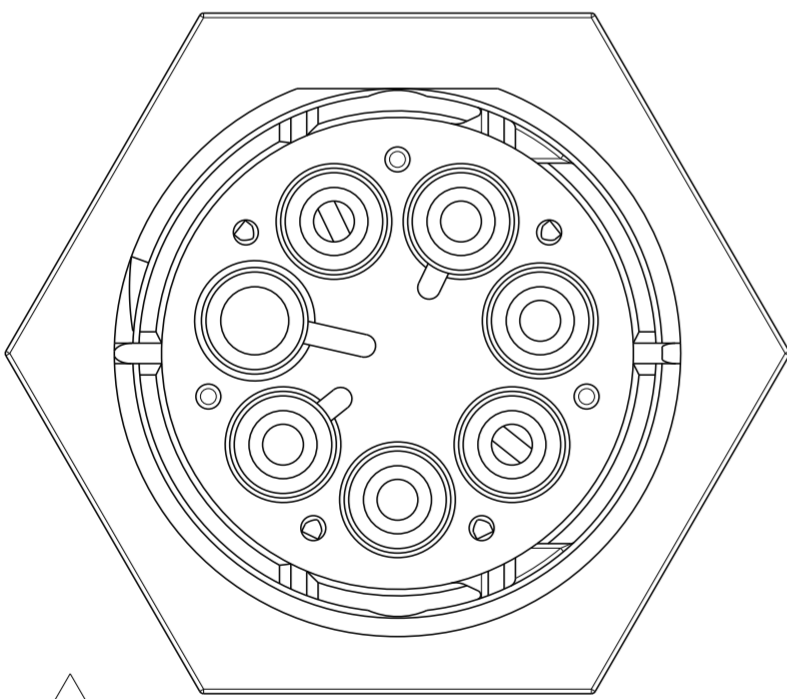
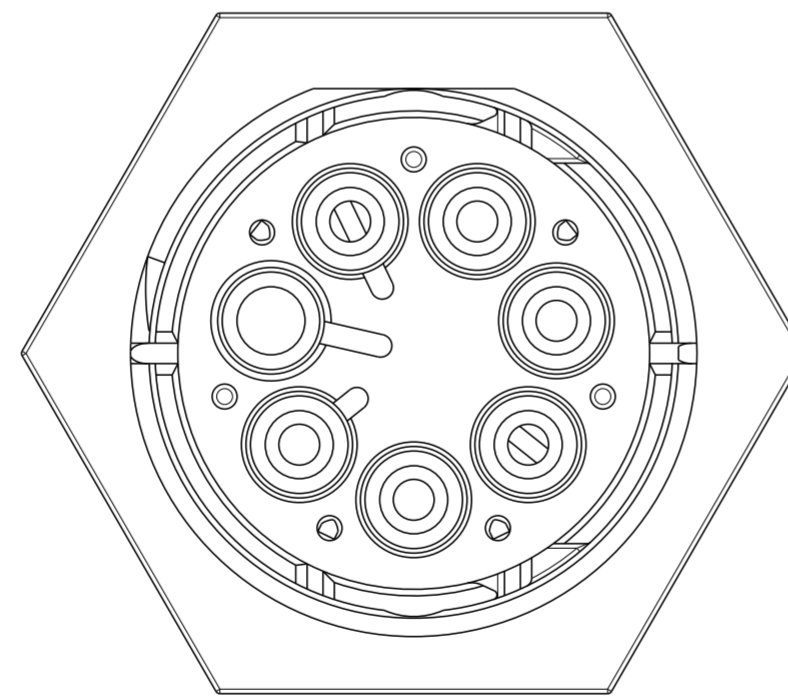
POLARIZATION TYPE "A"	POLARIZATION TYPE "B"	POLARIZATION TYPE "C"
		
PNs 0-293673-1 AND 1-293673-1	PNs 0-293673-2 AND 1-293673-2	PNs 0-293673-3 AND 1-293673-3
POLARIZATION TYPE "D"	POLARIZATION TYPE "E"	
		
PNs 0-293673-4 AND 1-293673-4	PNs 0-293673-5 AND 1-293673-5	

NOTE	POL. KEYING	COLOUR	DESCRIPTION	REV.	P/N
1	E	BLACK	SOCKET HSG 5 POLES PANEL MOUNT NECTOR* M-LINE	A	1-293687-5
1, 13	D	BLACK	SOCKET HSG 5 POLES PANEL MOUNT NECTOR* M-LINE	A	1-293687-4
1	C	BLACK	SOCKET HSG 5 POLES PANEL MOUNT NECTOR* M-LINE	A	1-293687-3
1	B	BLACK	SOCKET HSG 5 POLES PANEL MOUNT NECTOR* M-LINE	A	1-293687-2
1	A	BLACK	SOCKET HSG 5 POLES PANEL MOUNT NECTOR* M-LINE	A	1-293687-1
1	E	NATURAL	SOCKET HSG 5 POLES PANEL MOUNT NECTOR* M-LINE	A	0-293687-5
1, 13	D	NATURAL	SOCKET HSG 5 POLES PANEL MOUNT NECTOR* M-LINE	A	0-293687-4
1	C	NATURAL	SOCKET HSG 5 POLES PANEL MOUNT NECTOR* M-LINE	A	0-293687-3
1	B	NATURAL	SOCKET HSG 5 POLES PANEL MOUNT NECTOR* M-LINE	A	0-293687-2
1	A	NATURAL	SOCKET HSG 5 POLES PANEL MOUNT NECTOR* M-LINE	A	0-293687-1

THIS DRAWING IS A CONTROLLED DOCUMENT.

DWN	M. ZUCCA	01APR2011
CHK	M. ZUCCA	01APR2011
APVD	G. TURCO	01APR2011

STE TE Connectivity

NAME: SOCKET HOUSING PANEL MOUNT NECTOR* M-LINE 5 POLES UNSEALED VERSION

SIZE: A2 CAGE CODE: 0779 DRAWING NO: C-293687

Customer Drawing SCALE 3:1 SHEET 2 OF 3 REV B

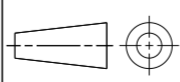
DIMENSIONS:	TOLERANCES UNLESS OTHERWISE SPECIFIED:
mm	0 PLC ±-
	1 PLC ±0.3
	2 PLC ±0.20
	3 PLC ±-
	4 PLC ±-
	ANGLES ±3°
MATERIAL:	FINISH
-	-

THIS DRAWING IS UNPUBLISHED. RELEASED FOR PUBLICATION 2011
 © COPYRIGHT 2011 ALL RIGHTS RESERVED.

LOC		DIST		REVISIONS			
P	LTR	DESCRIPTION	DATE	DWN	APVD		
-	-	SEE SHEET 1	-	-	-		

PN 293687-3 AS SHOWN

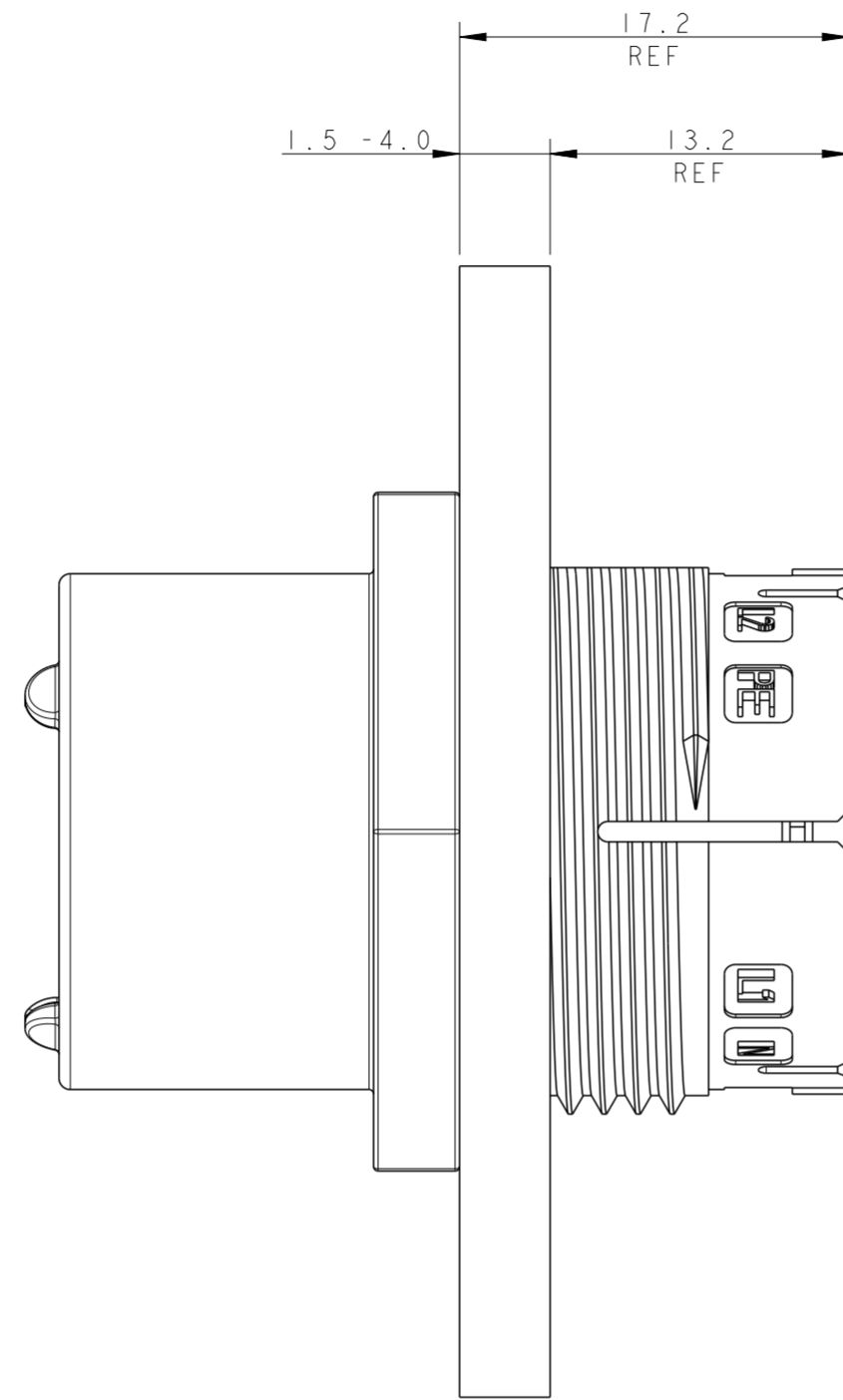

PANEL/WALL SUGGESTED LAYOUT



3D VIEWS,
FOR REFERENCE ONLY
PN 293687-3 AS SHOWN



SCALE 1:1

THIS DRAWING IS A CONTROLLED DOCUMENT.		DWN M. ZUCCA 01APR2011	 TE Connectivity	
DIMENSIONS: mm		CHK M. ZUCCA 01APR2011		
TOLERANCES UNLESS OTHERWISE SPECIFIED:		APVD G. TURCO 01APR2011	NAME SOCKET HOUSING PANEL MOUNT NECTOR* M-LINE 5 POLES UNSEALED VERSION	
0 PLC ± 1 PLC ±0.3 2 PLC ±0.20 3 PLC ± 4 PLC ±		PRODUCT SPEC -	SIZE A200779	
ANGLES ±3°		APPLICATION SPEC -	CAGE CODE C-293687	
FINISH		WEIGHT -	DRAWING NO C-293687	
MATERIAL -		Customer Drawing		RESTRICTED TO -
		SCALE 3:1		SHEET 3 OF 3
				REV B