

- Low-loss RF SAW Filter
- Miniature 3 x 3 mm SMD Package
- Complies with Directive 2002/95/EC (RoHS) 

SF2255E

**1056 MHz
SAW Filter**

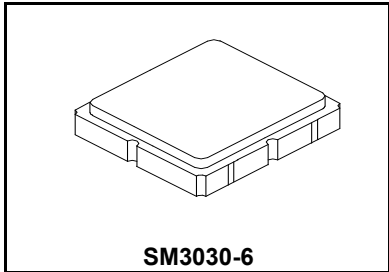

Absolute Maximum Ratings

Rating	Value	Units
Input Power Level	+10	dBm
DC Voltage on any Non-grounded Terminal	3	V
Operating Temperature Range	-30 to +85	°C
Storage Temperature Range in Tape and Reel	-40 to +85	°C
Maximum Soldering Profile, 5 cycles/10 seconds maximum	265	°C

Electrical Characteristics

Characteristic	Sym	Notes	Min	Typ	Max	Units
Center Frequency	f_C			1056		MHz
Insertion Loss, 1041 to 1071 MHz	IL			2.6	3.5	dB
Amplitude Ripple, 1041 to 1071 MHz				0.8	1.5	dB _{P-P}
VSWR, 1041 to 1071 MHz				1.9:1	2.2:1	
Attenuation, Referenced to 0 dB:						dB
1006 MHz			40	42		
1106 MHz			25	34		
1146 MHz			40	46		
Source Impedance	Z_S			50		Ω
Load Impedance	Z_L			50		Ω
Case Style	SM3030-6 3.0 x 3.0 mm Nominal Footprint					
Lid Symbolization (Y=year, WW=week, S=shift) dot=pin 1 indicator	A02, YWWS					
Standard Reel Quantity	Reel Size 7 inch					500 Pieces/Reel
	Reel Size 13 inch					3000 Pieces/Reel

Electrical Connections

Connection	Terminals
Input	2
Output	5
Case Ground	All others

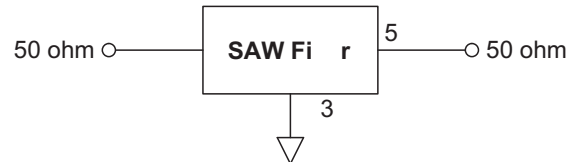

 **CAUTION: Electrostatic Sensitive Device. Observe precautions for handling.**

NOTES:

1. Unless noted otherwise, all specifications apply over the operating temperature range with filter soldered to the specified demonstration board with impedance matching to 50 Ω and measured with 50 Ω network analyzer.
2. Unless noted otherwise, all frequency specifications are referenced to the nominal center frequency, f_C .
3. Rejection is measured as attenuation below the minimum IL point in the passband. Rejection in final user application is dependent on PCB layout and external impedance matching design. See Application Note No. 42 for details.
4. The design, manufacturing process, and specifications of this filter are subject to change.
5. Either Port 1 or Port 2 may be used for either input or output in the design. However, impedances and impedance matching may vary between Port 1 and Port 2, so that the filter must always be installed in one direction per the circuit design.
6. US and international patents may apply.
7. Murata, stylized Murata logo, and Murata N.A., Inc. are registered trademarks of Murata Manufacturing Co., Ltd.

Filter Passband Response

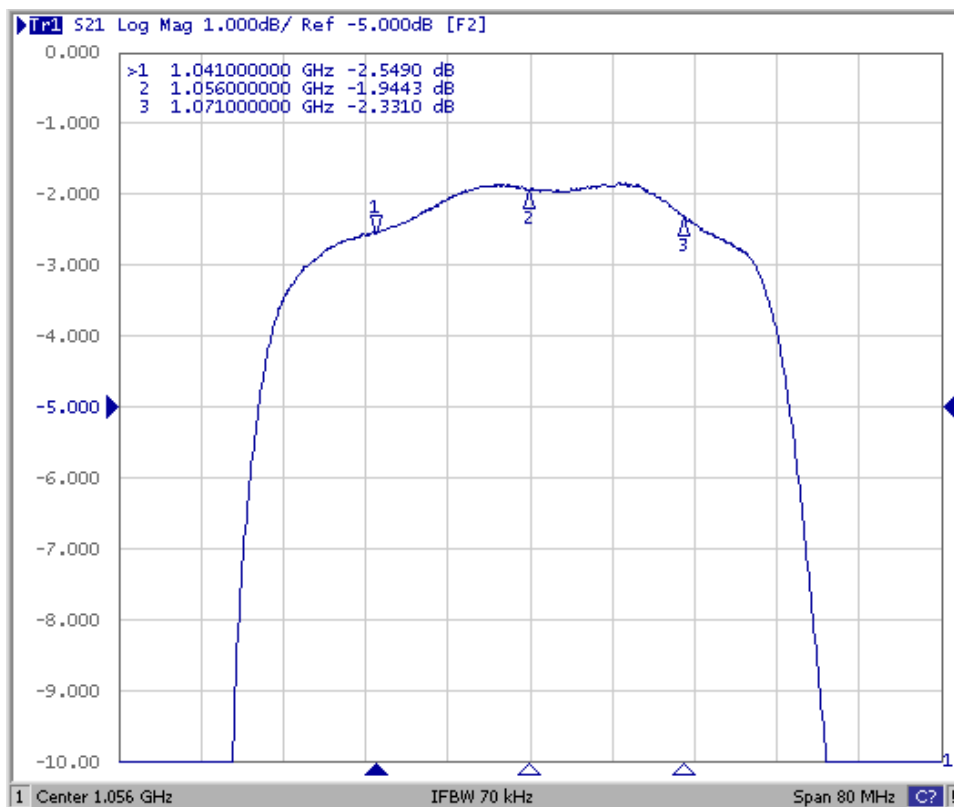

Filter Skirt Response

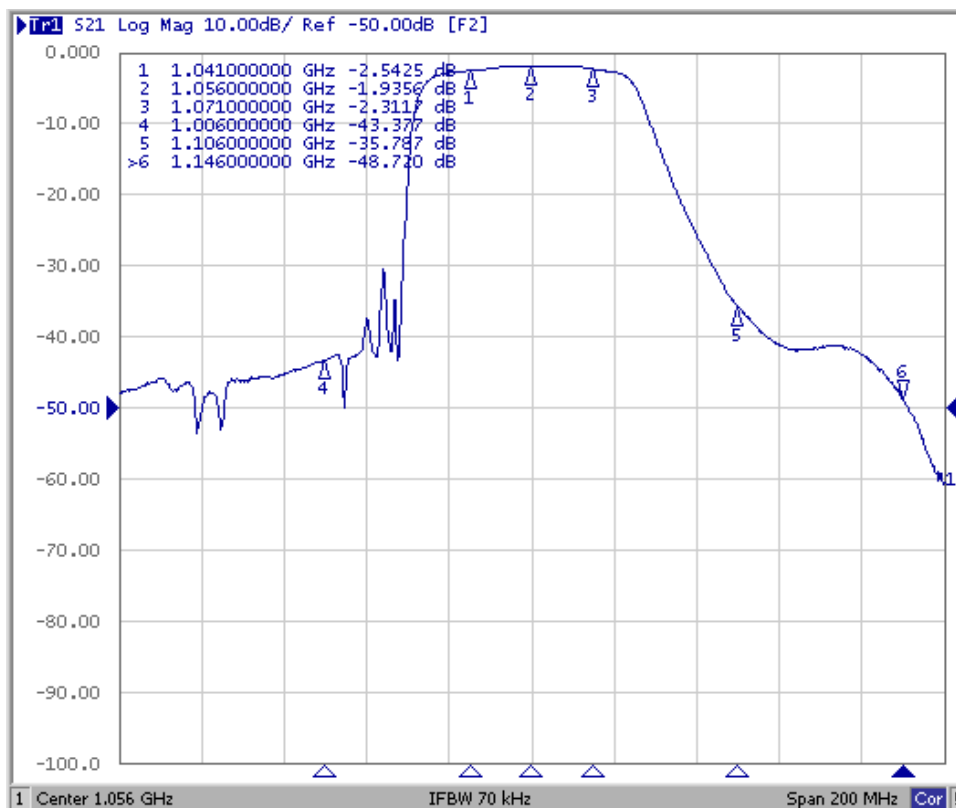

SM3030-6 Case

6-Terminal Ceramic Surface-Mount Case 3.0 X 3.0 mm Nominal Footprint



PCB Footprint Top View

Case and PCB Footprint Dimensions

Dimension	mm			Inches		
	Min	Nom	Max	Min	Nom	Max
A	2.87	3.00	3.13	0.113	0.118	0.123
B	2.87	3.00	3.13	0.113	0.118	0.123
C	1.12	1.25	1.38	0.044	0.049	0.054
D	0.77	0.90	1.03	0.030	0.035	0.040
E	2.67	2.80	2.93	0.105	0.110	0.115
F	1.47	1.60	1.73	0.058	0.063	0.068
G	0.72	0.85	0.98	0.028	0.033	0.038
H	1.37	1.50	1.63	0.054	0.059	0.064
I	0.47	0.60	0.73	0.019	0.024	0.029
J	1.17	1.30	1.43	0.046	0.051	0.056
K		3.20			0.126	
L		1.70			0.067	
M		1.05			0.041	
N		0.81			0.032	
O		0.38			0.015	

Case Materials

Materials	
Solder Pad Plating	0.3 to 1.0 μm Gold over 1.27 to 8.89 μm Nickel
Lid Plating	2.0 to 3.0 μm Nickel
Body	Al_2O_3 Ceramic
Pb Free	

TOP VIEW

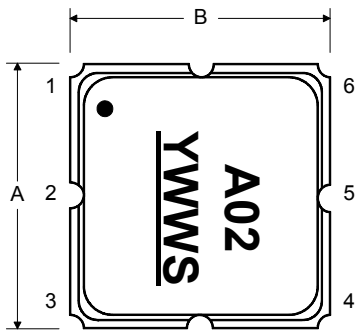

BOTTOM VIEW

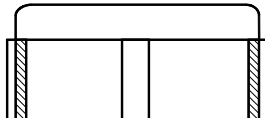
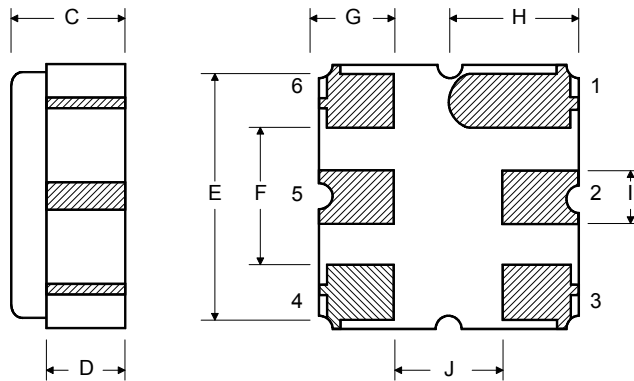

Tape and Reel Specifications

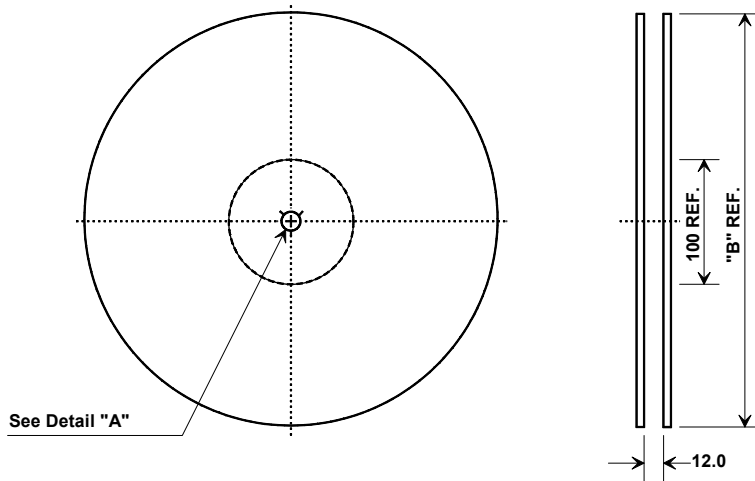

"B"		Quantity Per Reel
Inches	millimeters	
7	178	500
13	330	3000

See Detail "A"

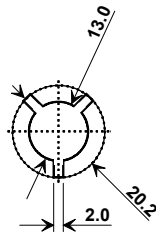

COMPONENT ORIENTATION and DIMENSIONS

Carrier Tape Dimensions	
Ao	3.35 mm
Bo	3.35 mm
Ko	1.40 mm
Pitch	8.0 mm
W	12.0 mm

