

Trench gate field-stop IGBT, M series 1200 V, 8 A low-loss

Datasheet - production data

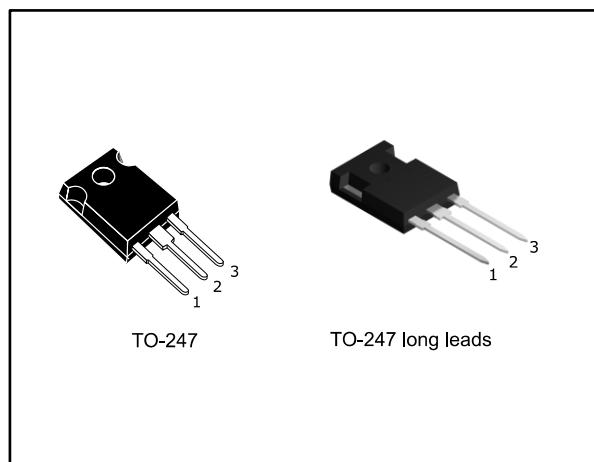
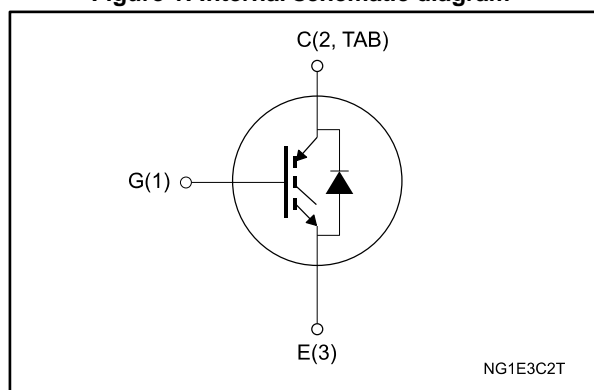

Figure 1: Internal schematic diagram



Features

- 10 μ s of short-circuit withstand time
- $V_{CE(sat)} = 1.85$ V (typ.) @ $I_C = 8$ A
- Tight parameter distribution
- Safer paralleling
- Low thermal resistance
- Soft and very fast recovery antiparallel diode

Applications

- Industrial drives
- UPS
- Solar
- Welding

Description

These devices are IGBTs developed using an advanced proprietary trench gate field-stop structure. These devices are part of the M series IGBTs, which represent an optimal balance between inverter system performance and efficiency where low-loss and short-circuit functionality are essential. Furthermore, the positive $V_{CE(sat)}$ temperature coefficient and tight parameter distribution result in safer paralleling operation.

Table 1: Device summary

Order code	Marking	Package	Packing
STGW8M120DF3	G8M120DF3	TO-247	Tube
STGWA8M120DF3		TO-247 long leads	

Contents

1	Electrical ratings	3
2	Electrical characteristics	4
	2.1 Electrical characteristics (curves).....	6
3	Test circuits	11
4	Package information	12
	4.1 TO-247 package information.....	12
	4.2 TO-247 long leads package information	14
5	Revision history	16

1 Electrical ratings

Table 2: Absolute maximum ratings

Symbol	Parameter	Value	Unit
V_{CES}	Collector-emitter voltage ($V_{GE} = 0$ V)	1200	V
I_C	Continuous collector current at $T_C = 25$ °C	16	A
I_C	Continuous collector current at $T_C = 100$ °C	8	A
$I_{CP}^{(1)}$	Pulsed collector current	32	A
V_{GE}	Gate-emitter voltage	± 20	V
I_F	Continuous forward current at $T_C = 25$ °C	16	A
I_F	Continuous forward current at $T_C = 100$ °C	8	A
$I_{FP}^{(1)}$	Pulsed forward current	32	A
P_{TOT}	Total dissipation at $T_C = 25$ °C	167	W
T_{STG}	Storage temperature range	-55 to 150	°C
T_J	Operating junction temperature range	-55 to 175	°C

Notes:

⁽¹⁾Pulse width limited by maximum junction temperature.

Table 3: Thermal data

Symbol	Parameter	Value	Unit
R_{thJC}	Thermal resistance junction-case IGBT	0.9	°C/W
R_{thJC}	Thermal resistance junction-case diode	1.47	°C/W
R_{thJA}	Thermal resistance junction-ambient	50	°C/W

2 Electrical characteristics

$T_C = 25\text{ °C}$ unless otherwise specified

Table 4: Static characteristics

Symbol	Parameter	Test conditions	Min.	Typ.	Max.	Unit
$V_{(BR)CES}$	Collector-emitter breakdown voltage	$V_{GE} = 0\text{ V}$, $I_C = 2\text{ mA}$	1200			V
$V_{CE(sat)}$	Collector-emitter saturation voltage	$V_{GE} = 15\text{ V}$, $I_C = 8\text{ A}$		1.85	2.3	V
		$V_{GE} = 15\text{ V}$, $I_C = 8\text{ A}$, $T_J = 125\text{ °C}$		2.1		
		$V_{GE} = 15\text{ V}$, $I_C = 8\text{ A}$, $T_J = 175\text{ °C}$		2.2		
V_F	Forward on-voltage	$I_F = 8\text{ A}$		2.4	3.35	V
		$I_F = 8\text{ A}$, $T_J = 125\text{ °C}$		1.75		
		$I_F = 8\text{ A}$, $T_J = 175\text{ °C}$		1.55		
$V_{GE(th)}$	Gate threshold voltage	$V_{CE} = V_{GE}$, $I_C = 500\text{ }\mu\text{A}$	5	6	7	V
I_{CES}	Collector cut-off current	$V_{GE} = 0\text{ V}$, $V_{CE} = 1200\text{ V}$			25	μA
I_{GES}	Gate-emitter leakage current	$V_{GE} = \pm 20\text{ V}$, $V_{CE} = 0\text{ V}$			± 250	nA

Table 5: Dynamic characteristics

Symbol	Parameter	Test conditions	Min.	Typ.	Max.	Unit
C_{ies}	Input capacitance	$V_{CE} = 25\text{ V}$, $f = 1\text{ MHz}$, $V_{GE} = 0\text{ V}$	-	542	-	pF
C_{oes}	Output capacitance		-	74.4	-	
C_{res}	Reverse transfer capacitance		-	21	-	
Q_g	Total gate charge	$V_{CC} = 960\text{ V}$, $I_C = 8\text{ A}$, $V_{GE} = 0\text{ to }15\text{ V}$ (see Figure 30: "Gate charge test circuit")	-	32	-	nC
Q_{ge}	Gate-emitter charge		-	4.5	-	
Q_{gc}	Gate-collector charge		-	18.5	-	

Table 6: IGBT switching characteristics (inductive load)

Symbol	Parameter	Test conditions	Min.	Typ.	Max.	Unit
$t_{d(on)}$	Turn-on delay time	$V_{CE} = 600\text{ V}$, $I_C = 8\text{ A}$, $V_{GE} = 15\text{ V}$, $R_G = 33\ \Omega$ (see Figure 29: "Test circuit for inductive load switching")		20	-	ns
t_r	Current rise time			8.4	-	ns
$(di/dt)_{on}$	Turn-on current slope			800	-	A/ μ s
$t_{d(off)}$	Turn-off-delay time			126	-	ns
t_f	Current fall time			136	-	ns
$E_{on(1)}$	Turn-on switching energy			0.39	-	mJ
$E_{off(2)}$	Turn-off switching energy			0.37	-	mJ
E_{ts}	Total switching energy			0.76	-	mJ
$t_{d(on)}$	Turn-on delay time	$V_{CE} = 600\text{ V}$, $I_C = 8\text{ A}$, $V_{GE} = 15\text{ V}$, $R_G = 33\ \Omega$, $T_J = 175\text{ }^\circ\text{C}$ (see Figure 29: "Test circuit for inductive load switching")		19	-	ns
t_r	Current rise time			9.8	-	ns
$(di/dt)_{on}$	Turn-on current slope			656	-	A/ μ s
$t_{d(off)}$	Turn-off-delay time			134	-	ns
t_f	Current fall time			222	-	ns
$E_{on(1)}$	Turn-on switching energy			0.66	-	mJ
$E_{off(2)}$	Turn-off switching energy			0.58	-	mJ
E_{ts}	Total switching energy			1.24	-	mJ
t_{sc}	Short-circuit withstand time	$V_{CC} \leq 600\text{ V}$, $V_{GE} = 15\text{ V}$, $T_{Jstart} \leq 150\text{ }^\circ\text{C}$	10		-	μ s

Notes:

(1)Including the reverse recovery of the diode

(2)Including the tail of the collector current

Table 7: Diode switching characteristics (inductive load)

Symbol	Parameter	Test conditions	Min.	Typ.	Max.	Unit	
t_{rr}	Reverse recovery time	$I_F = 8\text{ A}$, $V_R = 600\text{ V}$, $V_{GE} = 15\text{ V}$, $R_G = 33\ \Omega$ $(di/dt = 1000\text{ A}/\mu\text{s})$ (see Figure 29: "Test circuit for inductive load switching")	-	103	-	ns	
Q_{rr}	Reverse recovery charge			-	0.87	-	μ C
I_{rrm}	Reverse recovery current			-	19.2	-	A
dl_{rr}/dt	Peak rate of fall of reverse recovery current during t_b			-	720	-	A/ μ s
E_{rr}	Reverse recovery energy			-	211	-	μ J
t_{rr}	Reverse recovery time	$I_F = 8\text{ A}$, $V_R = 600\text{ V}$, $V_{GE} = 15\text{ V}$, $T_J = 175\text{ }^\circ\text{C}$, $R_G = 33\ \Omega$ ($di/dt = 840\text{ A}/\mu\text{s}$) (see Figure 29: "Test circuit for inductive load switching")	-	280	-	ns	
Q_{rr}	Reverse recovery charge			-	1.9	-	μ C
I_{rrm}	Reverse recovery current			-	21.8	-	A
dl_{rr}/dt	Peak rate of fall of reverse recovery current during t_b			-	450	-	A/ μ s
E_{rr}	Reverse recovery energy			-	404	-	μ J

2.1 Electrical characteristics (curves)

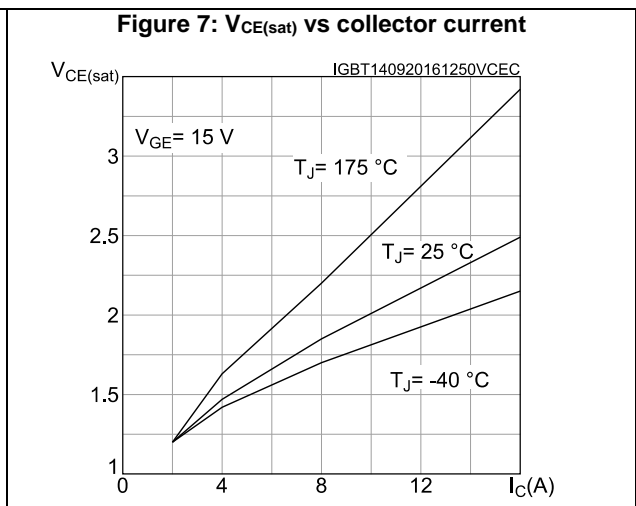
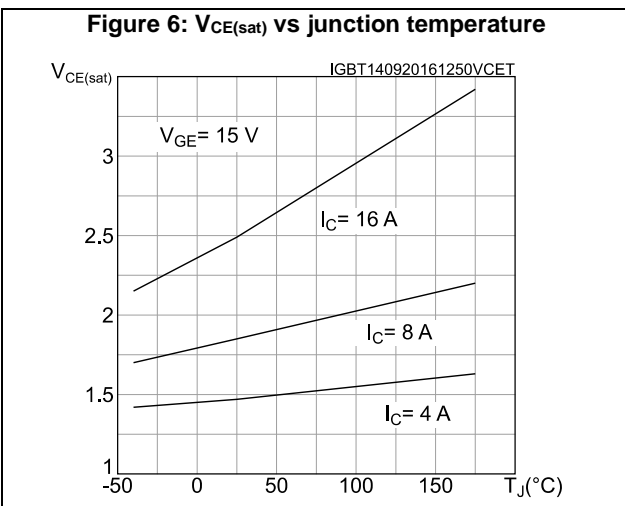
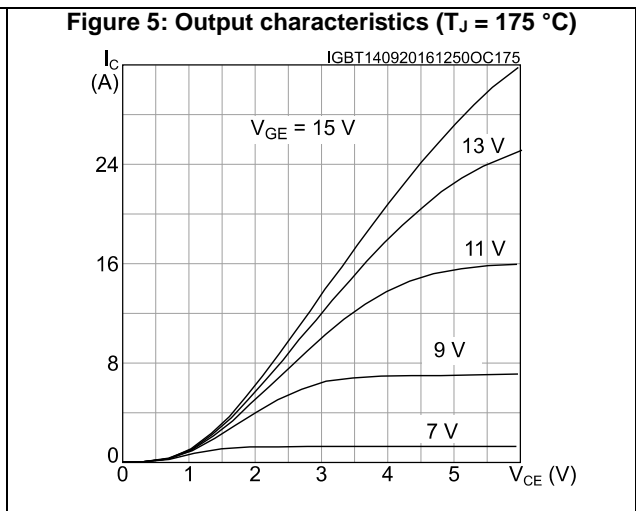
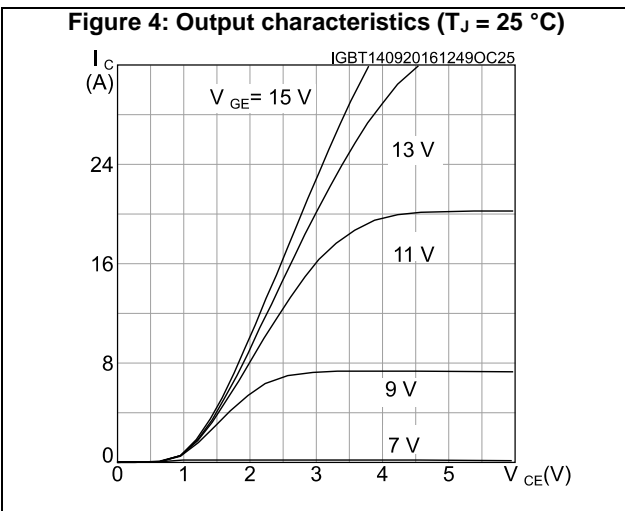
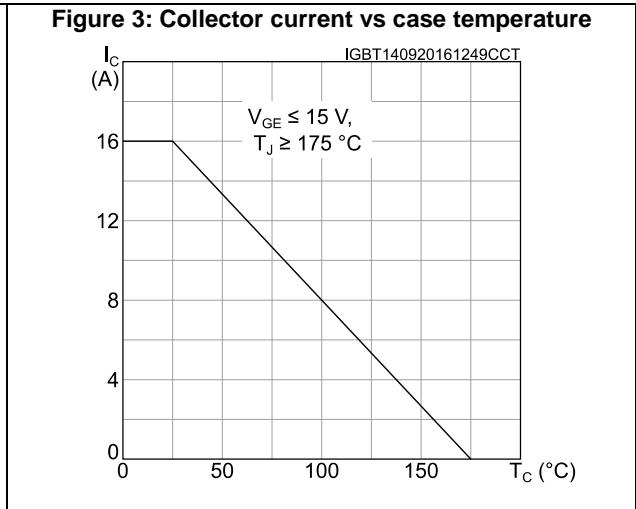
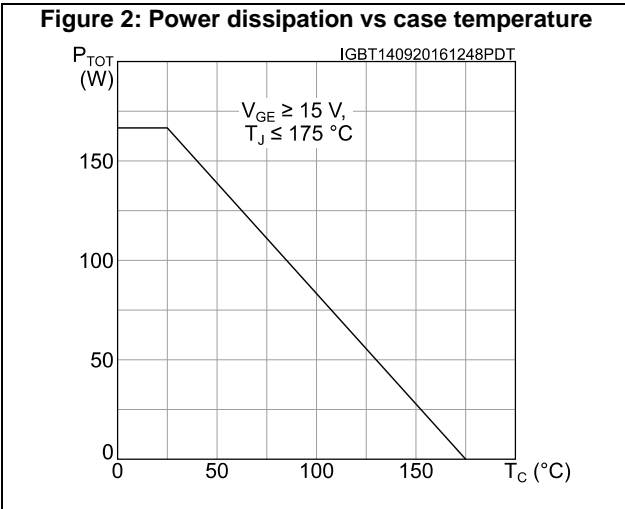

Figure 8: Collector current vs switching frequency

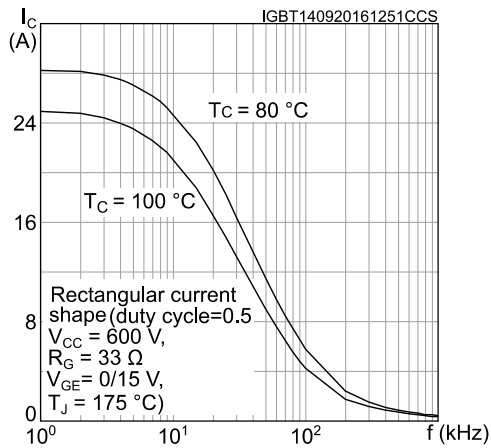

Figure 9: Forward bias safe operating area

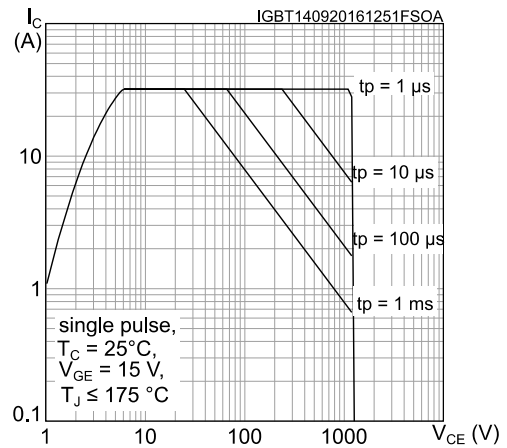

Figure 10: Transfer characteristics

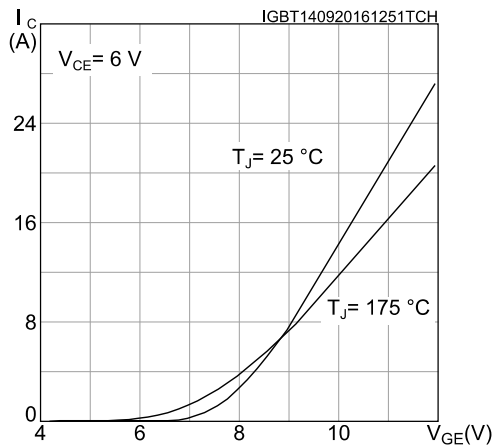

Figure 11: Diode VF vs forward current

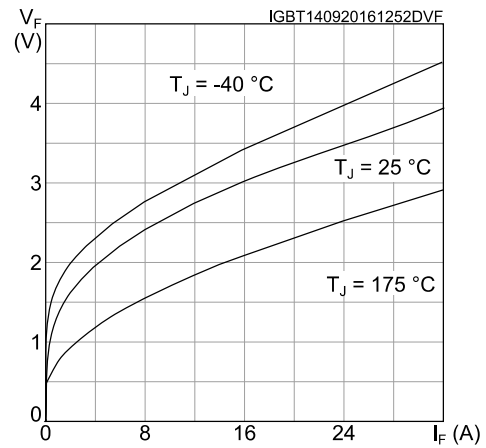

Figure 12: Normalized VGE(th) vs junction temperature

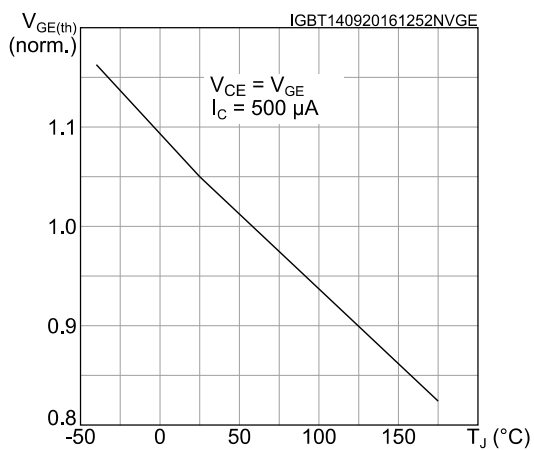
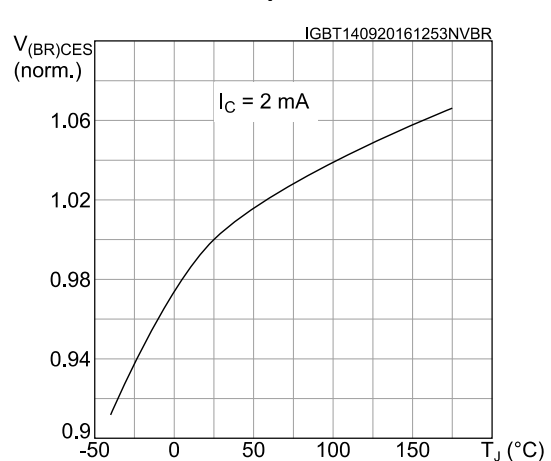

Figure 13: Normalized V(BR)CES vs junction temperature



Electrical characteristics

STGW8M120DF3, STGWA8M120DF3

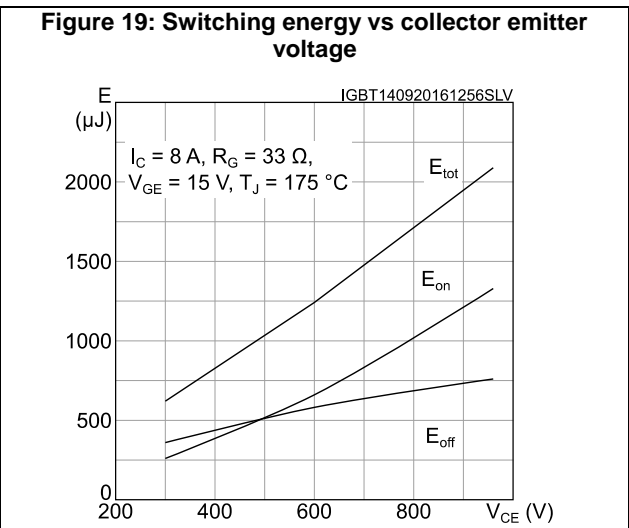
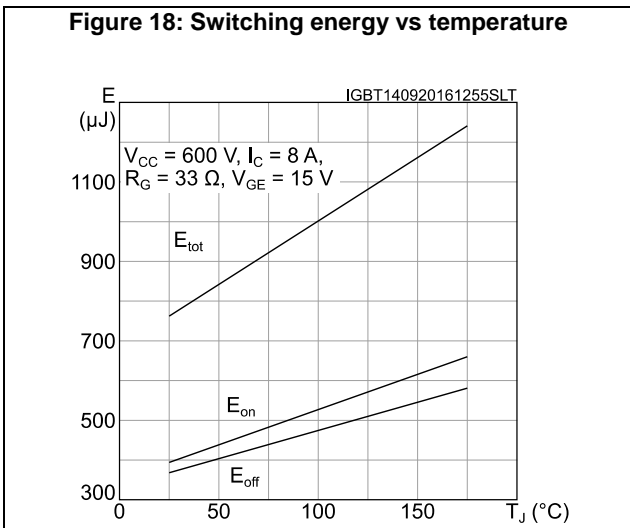
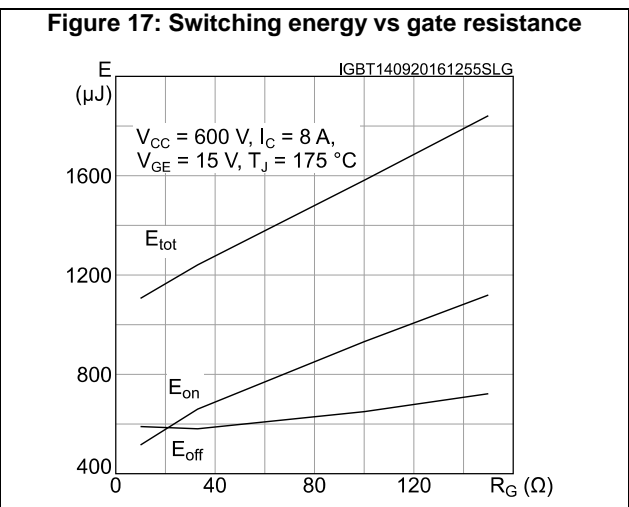
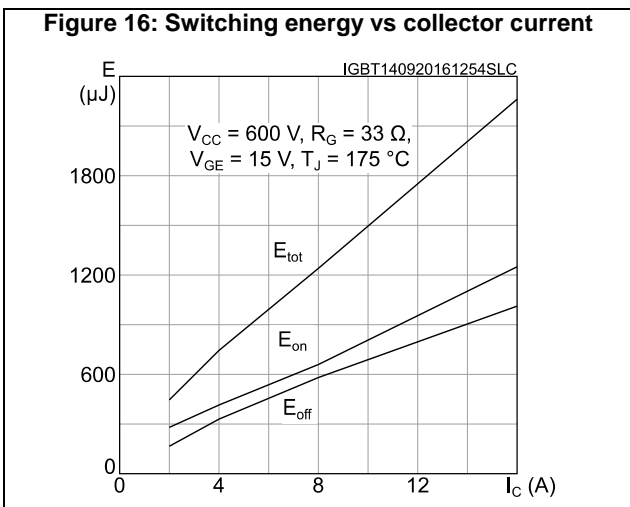
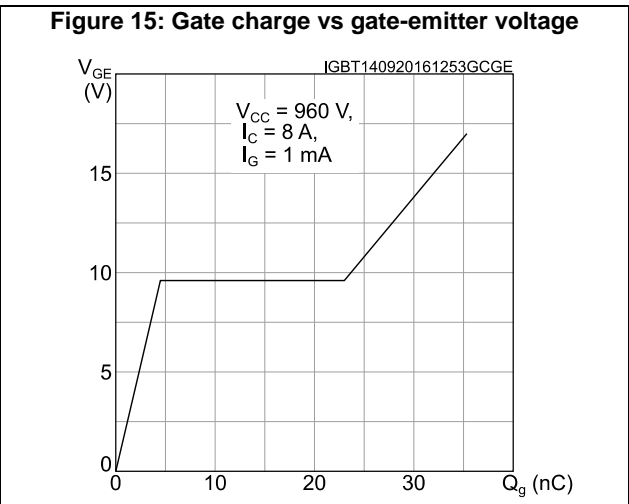
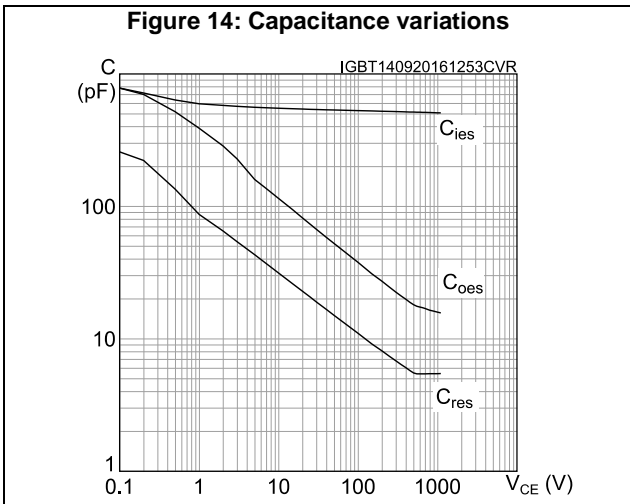

Figure 20: Short-circuit time and current vs V_{GE}

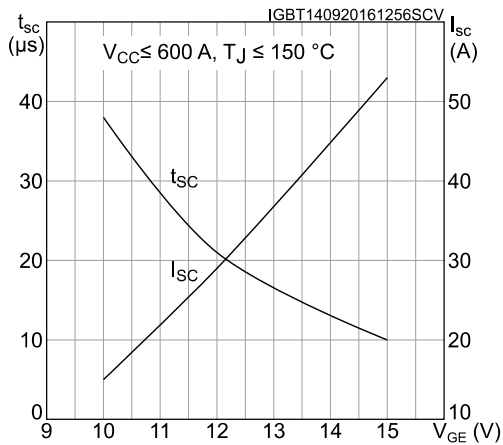

Figure 21: Switching times vs collector current

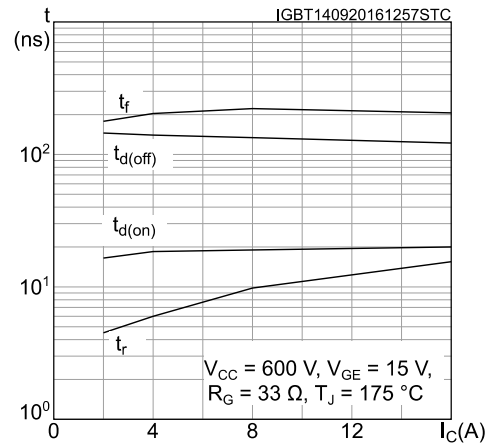

Figure 22: Switching times vs gate resistance

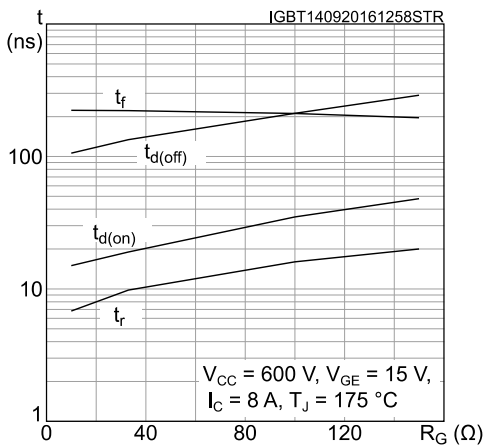

Figure 23: Reverse recovery current vs diode current slope

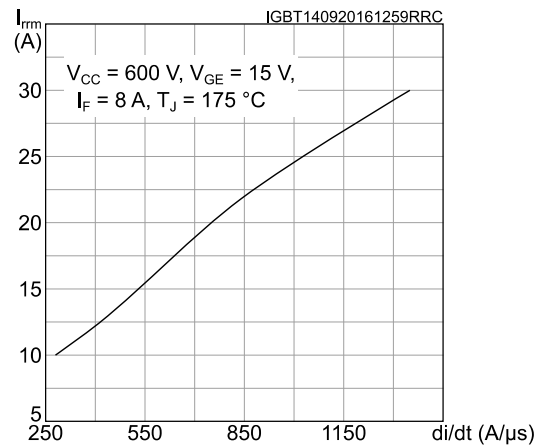

Figure 24: Reverse recovery time vs diode current slope

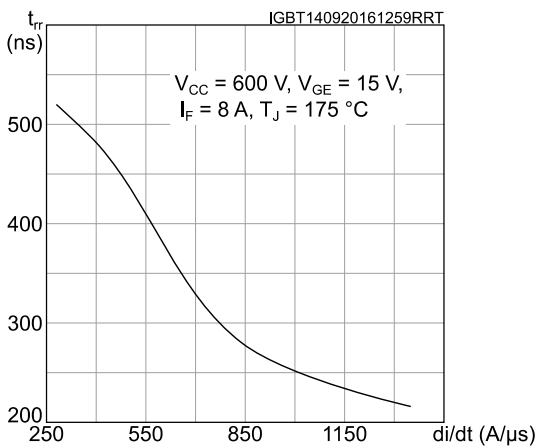

Figure 25: Reverse recovery charge vs diode current slope

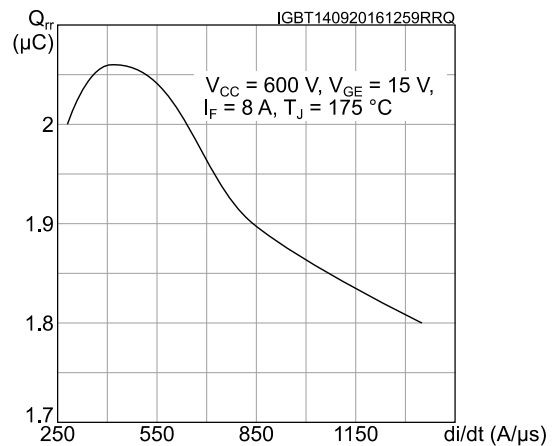

Figure 26: Reverse recovery energy vs diode current slope

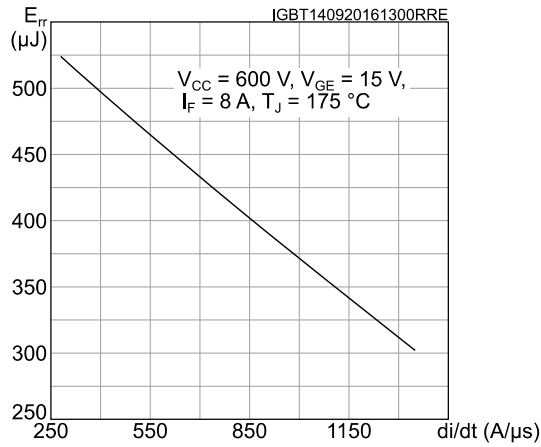

Figure 27: Thermal impedance for IGBT

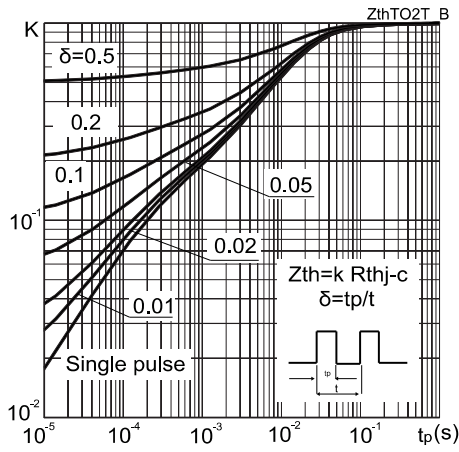
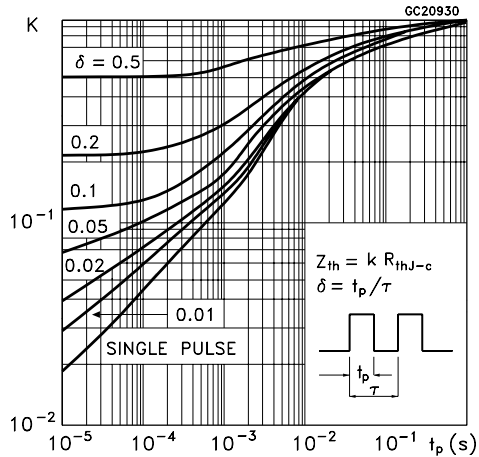
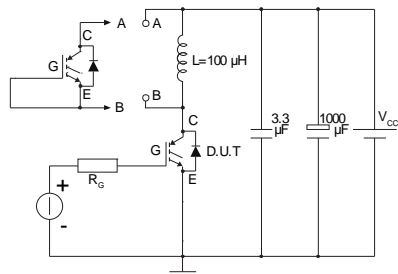

Figure 28: Thermal impedance for diode



3 Test circuits

Figure 29: Test circuit for inductive load switching



AM01504v1

Figure 30: Gate charge test circuit

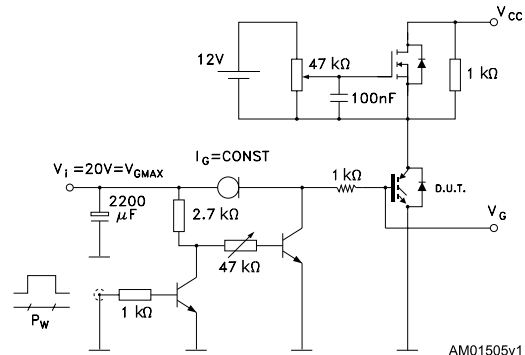

AM01505v1

Figure 31: Switching waveform

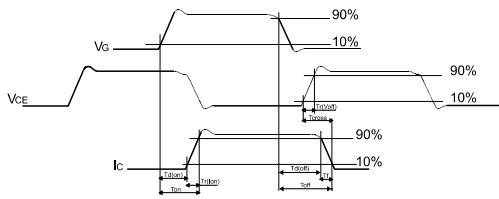

AM01506v1

Figure 32: Diode reverse recovery waveform

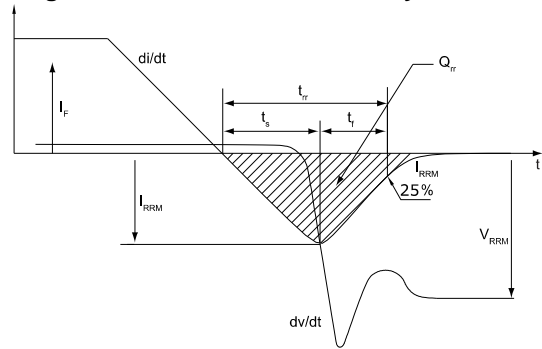

AM01507v1

4 Package information

In order to meet environmental requirements, ST offers these devices in different grades of ECOPACK® packages, depending on their level of environmental compliance. ECOPACK® specifications, grade definitions and product status are available at: www.st.com. ECOPACK® is an ST trademark.

4.1 TO-247 package information

Figure 33: TO-247 package outline

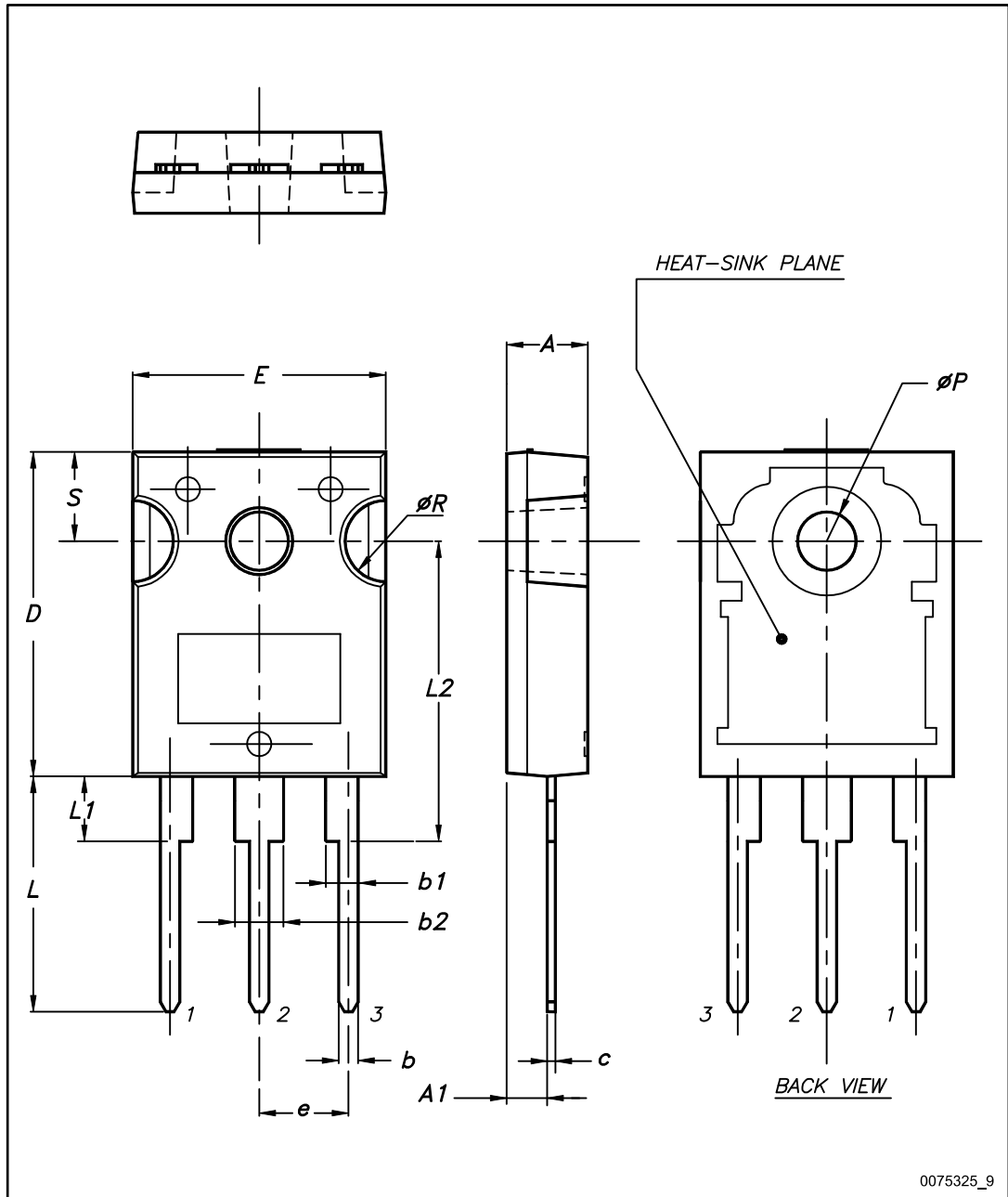

Table 8: TO-247 package mechanical data

Dim.	mm		
	Min.	Typ.	Max.
A	4.85		5.15
A1	2.20		2.60
b	1.0		1.40
b1	2.0		2.40
b2	3.0		3.40
c	0.40		0.80
D	19.85		20.15
E	15.45		15.75
e	5.30	5.45	5.60
L	14.20		14.80
L1	3.70		4.30
L2		18.50	
ØP	3.55		3.65
ØR	4.50		5.50
S	5.30	5.50	5.70

4.2 TO-247 long leads package information

Figure 34: TO-247 long leads package outline

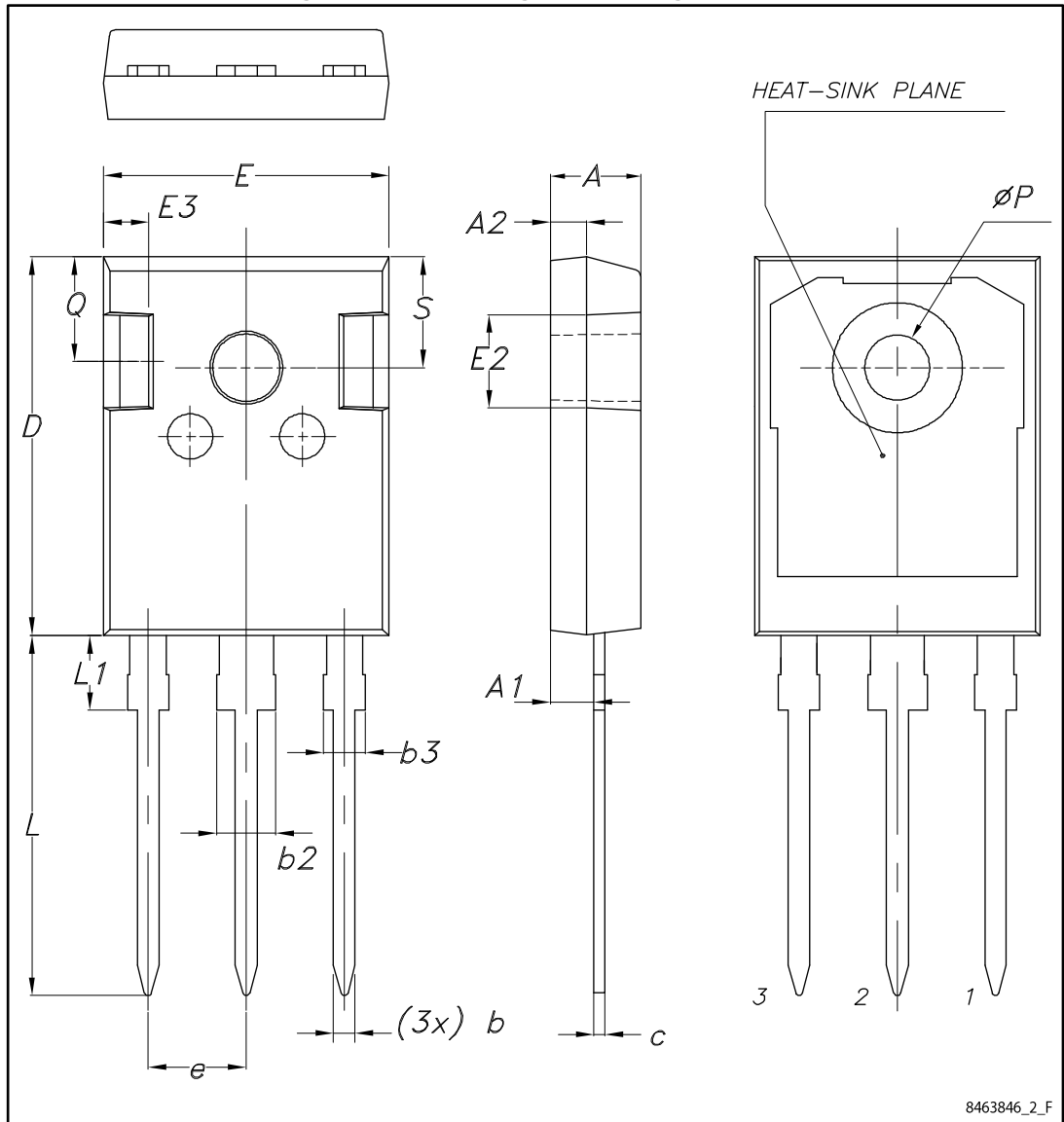

Table 9: TO-247 long leads package mechanical data

Dim.	mm		
	Min.	Typ.	Max.
A	4.90	5.00	5.10
A1	2.31	2.41	2.51
A2	1.90	2.00	2.10
b	1.16		1.26
b2			3.25
b3			2.25
c	0.59		0.66
D	20.90	21.00	21.10
E	15.70	15.80	15.90
E2	4.90	5.00	5.10
E3	2.40	2.50	2.60
e	5.34	5.44	5.54
L	19.80	19.92	20.10
L1			4.30
P	3.50	3.60	3.70
Q	5.60		6.00
S	6.05	6.15	6.25

5 Revision history

Table 10: Document revision history

Date	Revision	Changes
11-May-2016	1	First release.
19-Sep-2016	2	Datasheet promoted from preliminary to production data. Updated <i>Table 2: "Absolute maximum ratings"</i> . Updated <i>Section 2: "Electrical characteristics"</i> . Added <i>Section 2.1: "Electrical characteristics (curves)"</i> .
31-Oct-2017	3	Updated package silhouette on cover page. Updated <i>Table 4: "Static characteristics"</i> and <i>Table 5: "Dynamic characteristics"</i> . Minor text changes

IMPORTANT NOTICE – PLEASE READ CAREFULLY

STMicroelectronics NV and its subsidiaries ("ST") reserve the right to make changes, corrections, enhancements, modifications, and improvements to ST products and/or to this document at any time without notice. Purchasers should obtain the latest relevant information on ST products before placing orders. ST products are sold pursuant to ST's terms and conditions of sale in place at the time of order acknowledgement.

Purchasers are solely responsible for the choice, selection, and use of ST products and ST assumes no liability for application assistance or the design of Purchasers' products.

No license, express or implied, to any intellectual property right is granted by ST herein.

Resale of ST products with provisions different from the information set forth herein shall void any warranty granted by ST for such product.

ST and the ST logo are trademarks of ST. All other product or service names are the property of their respective owners.

Information in this document supersedes and replaces information previously supplied in any prior versions of this document.

© 2017 STMicroelectronics – All rights reserved