

**SERIES:** CP35 | **DESCRIPTION:** PELTIER MODULE**FEATURES**

- arcTEC™ structure on select models
- solid state device
- precise temperature control
- quiet operation



MODEL	input voltage <sup>1</sup> max (Vdc)	input current <sup>2</sup> max (A)	internal resistance <sup>3</sup> typ ( $\Omega \pm 10\%$ )	output Qmax <sup>4</sup>		output $\Delta T_{max}$ <sup>5</sup>	
				T <sub>h</sub> =27°C (W)	T <sub>h</sub> =50°C (W)	T <sub>h</sub> =27°C (°C)	T <sub>h</sub> =50°C (°C)
CP35147	2.1	3.5	0.44	3.9	4.3	68	75
CP35247	3.8	3.5	0.80	7.0	7.7	68	75
CP35301547	4.2	3.5	0.90	7.9	8.7	68	75
CP35347 <sup>6</sup>	8.6	3.5	1.93	16.0	17.8	70	77
CP353047 <sup>6</sup>	11.8	3.5	2.52	24.0	26.0	70	77
CP35447 <sup>6</sup>	15.4	3.5	3.3	29.0	32.0	70	77
CP354047 <sup>6</sup>	24.1	3.5	5.17	49.0	53.0	70	77

- Notes:
1. Maximum voltage at  $\Delta T_{max}$  and T<sub>h</sub>=27°C
  2. Maximum current to achieve  $\Delta T_{max}$
  3. Measured by AC 4-terminal method at 25°C
  4. Maximum heat absorbed at cold side occurs at I<sub>max</sub>, V<sub>max</sub>, and  $\Delta T=0^\circ\text{C}$
  5. Maximum temperature difference occurs at I<sub>max</sub>, V<sub>max</sub>, and Q=0W ( $\Delta T_{max}$  measured in a vacuum at 1.3 Pa)
  6. Designed with arcTEC™ structure.

## SPECIFICATIONS

parameter	conditions/description	min	typ	max	units
solder melting temperature	connection between thermoelectric pairs	235			°C
	CP35347, CP353047, CP35447, CP354047	138			°C
assembly compression				1	MPa
RoHS	yes				

## MECHANICAL DRAWING

units: mm

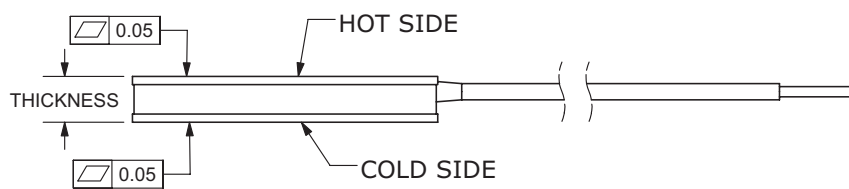

	MATERIAL	PLATING
ceramic plate	96% AL <sub>2</sub> O <sub>3</sub>	
wire leads	20 AWG	tin
sealer	silicon rubber 703 RTV (between cold and hot side plates)	
joint cover	silicon rubber 703 RTV	
marking	P/N & S/N printed on cold side surface	

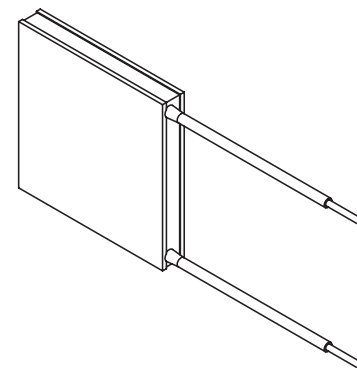
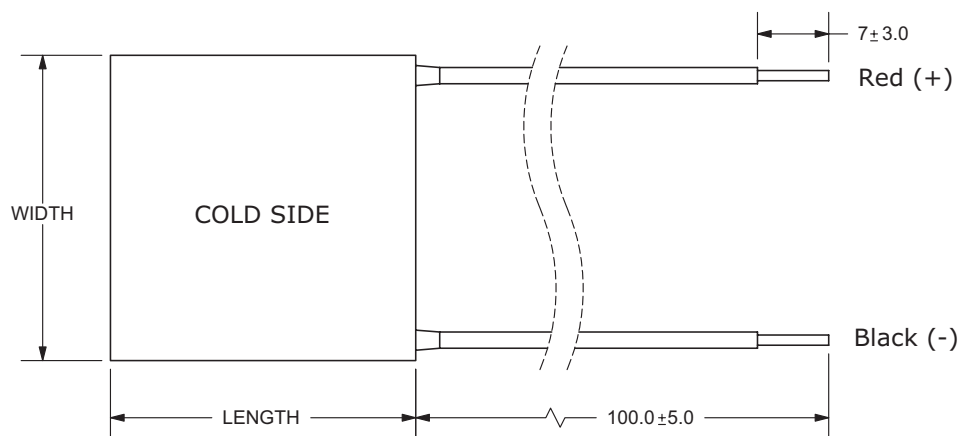

MODEL NO.	LENGTH (mm)	WIDTH (mm)	THICKNESS (mm)
CP35147	15 ± 0.3	15 ± 0.3	4.7 ± 0.1
CP35247	20 ± 0.3	20 ± 0.3	4.7 ± 0.1
CP35301547	30 ± 0.3	15 ± 0.3	4.7 ± 0.1
CP35347 <sup>1</sup>	30 ± 0.3	30 ± 0.3	4.7 ± 0.1
CP353047	30 ± 0.3	30 ± 0.3	4.7 ± 0.1
CP35447	40 ± 0.3	40 ± 0.3	4.65 ± 0.025
CP354047	40 ± 0.3	40 ± 0.3	4.7 ± 0.1

Notes: 1. Wire lead strip length on model CP35347 is 10 ± 3.0 mm.

### CP35147 PERFORMANCE (Th=27°C)

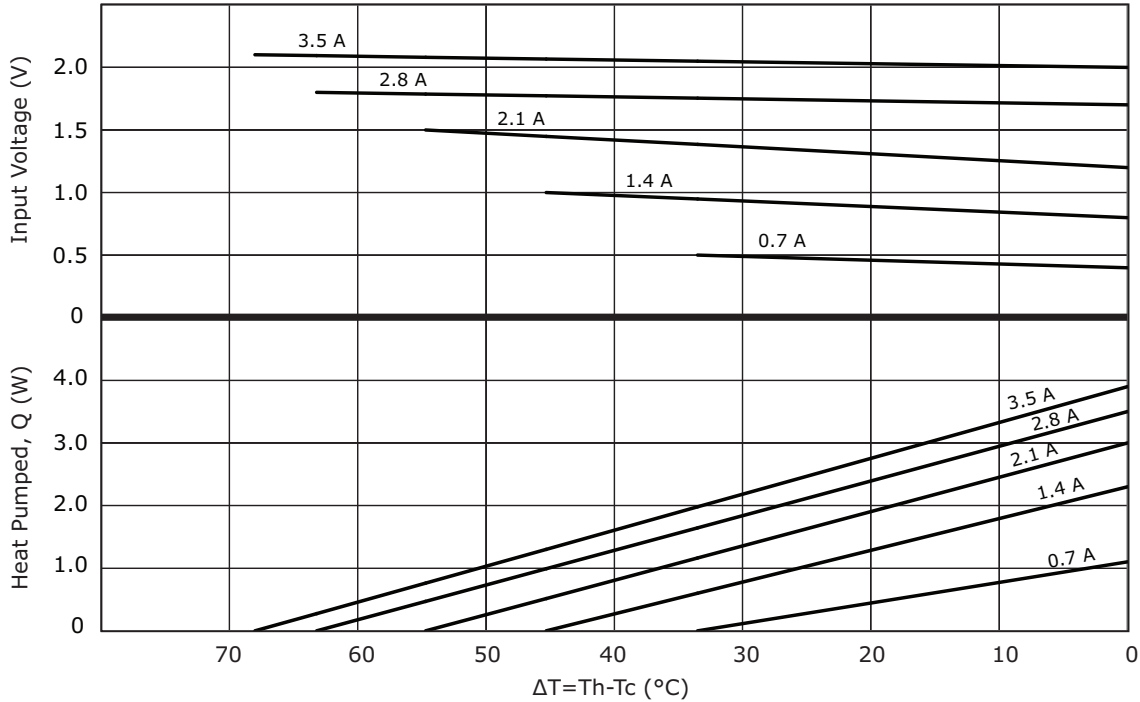

### CP35147 PERFORMANCE (Th=50°C)



### CP35247 PERFORMANCE (Th=27°C)

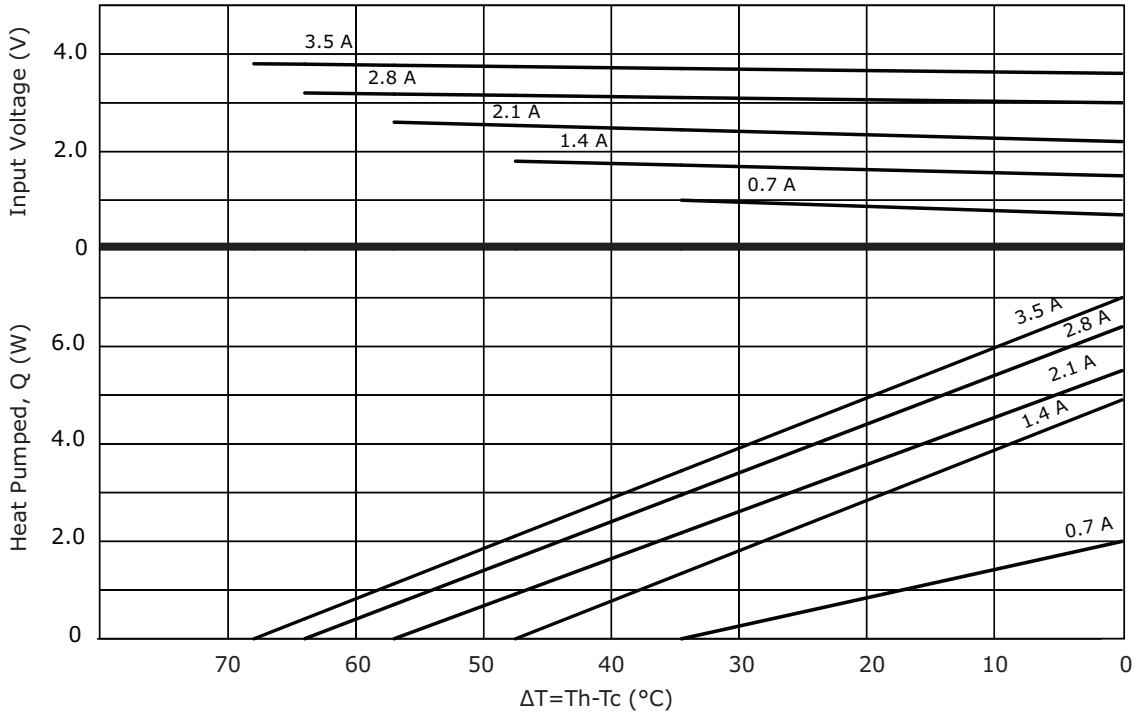

### CP35247 PERFORMANCE (Th=50°C)

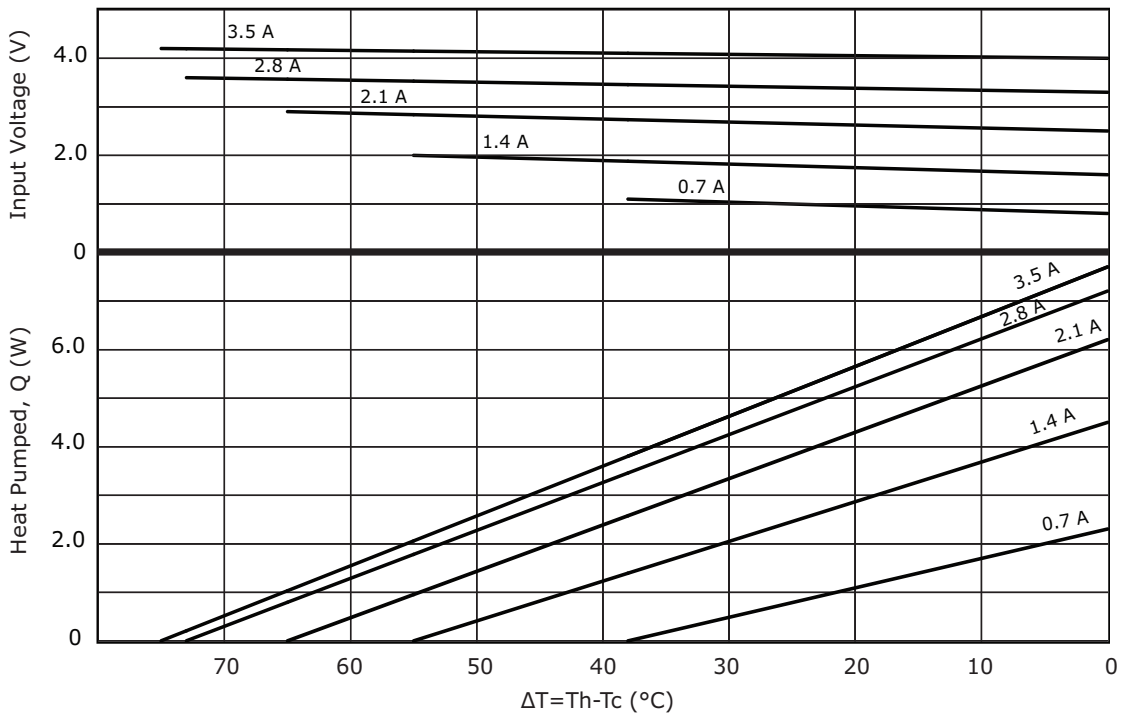

### CP35301547 PERFORMANCE (Th=27°C)

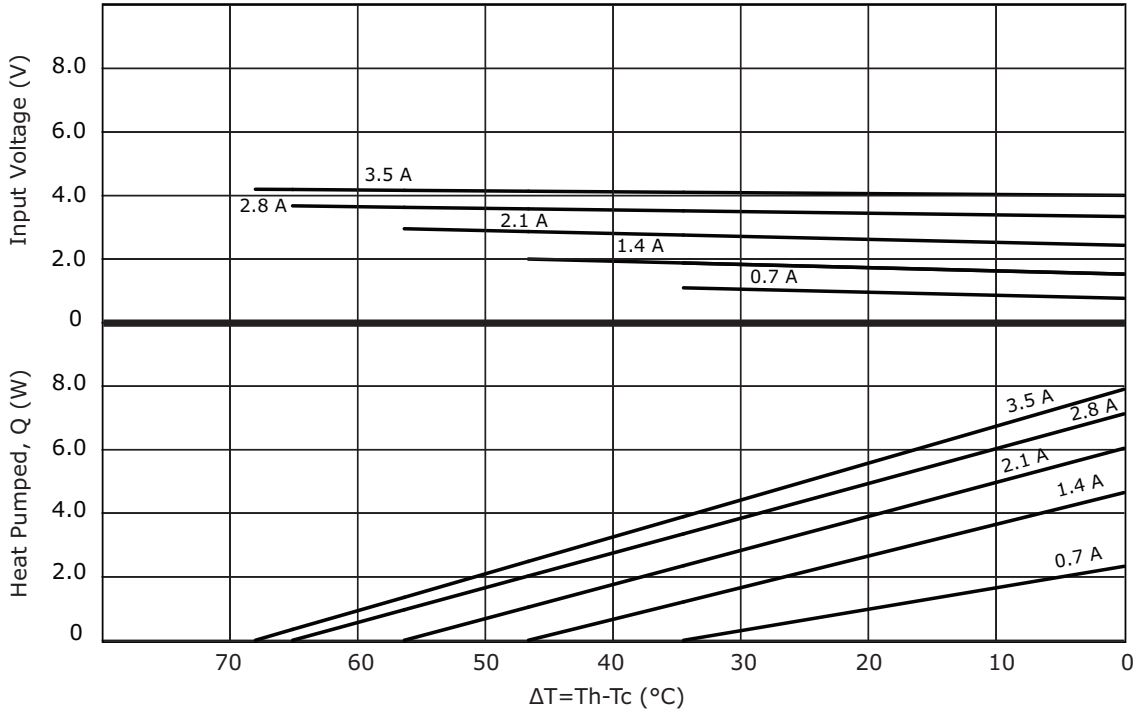

### CP35301547 PERFORMANCE (Th=50°C)

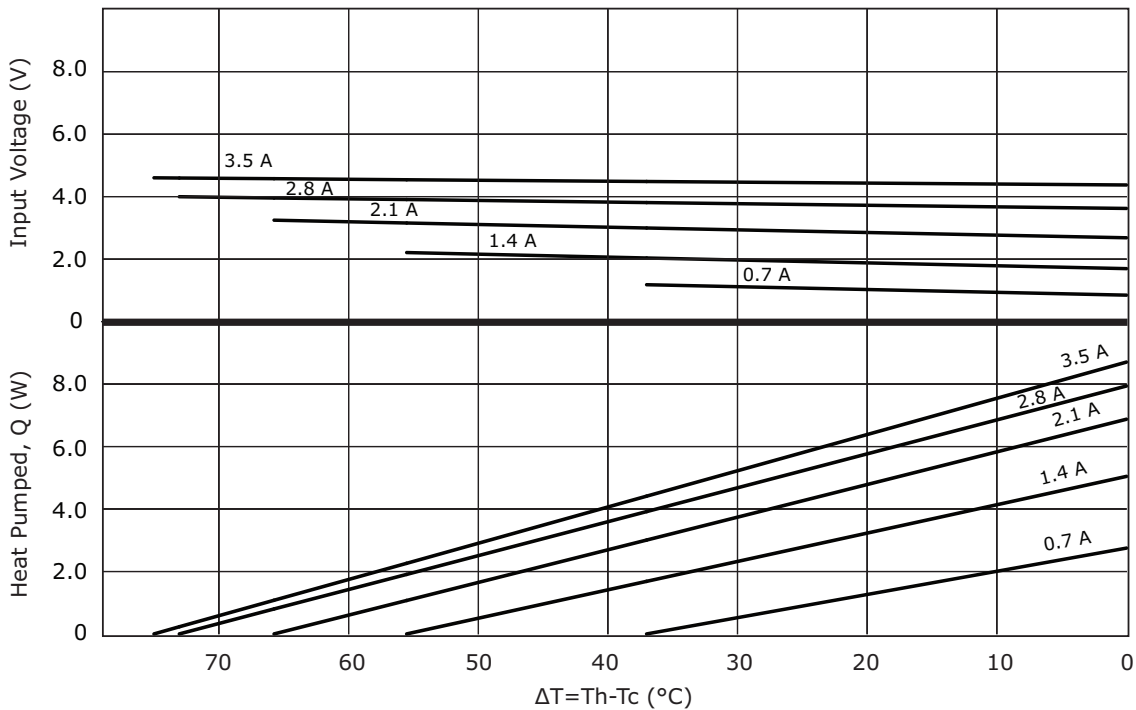

### CP35347 PERFORMANCE (Th=27°C)

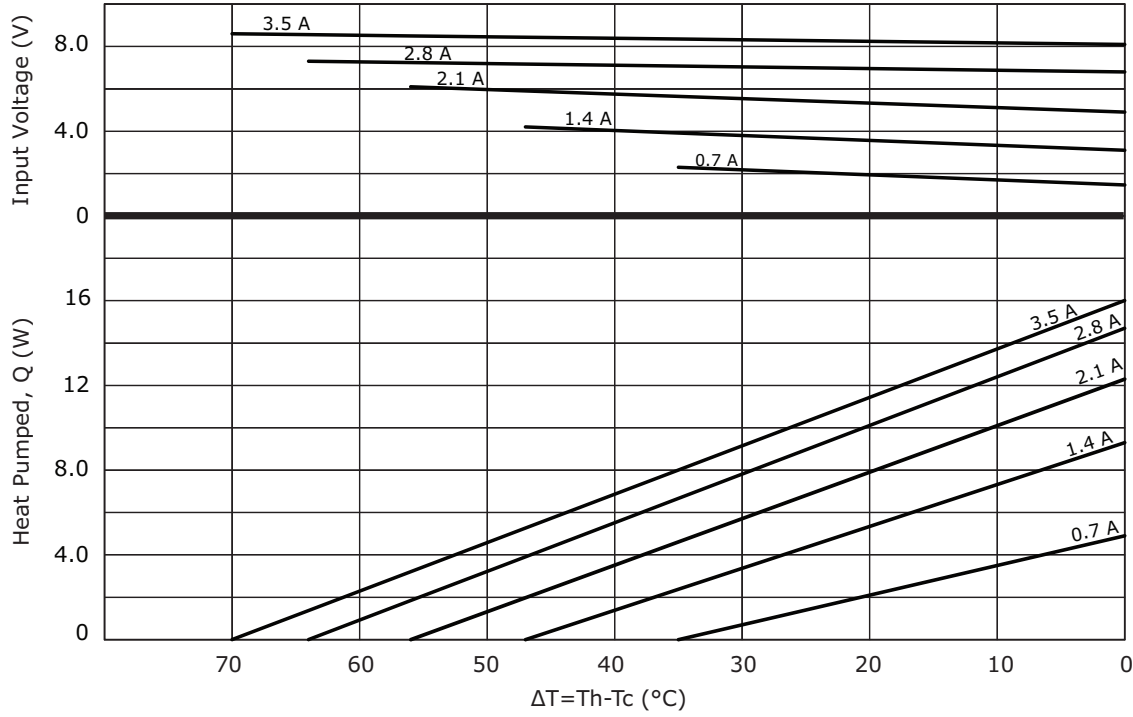

### CP35347 PERFORMANCE (Th=50°C)

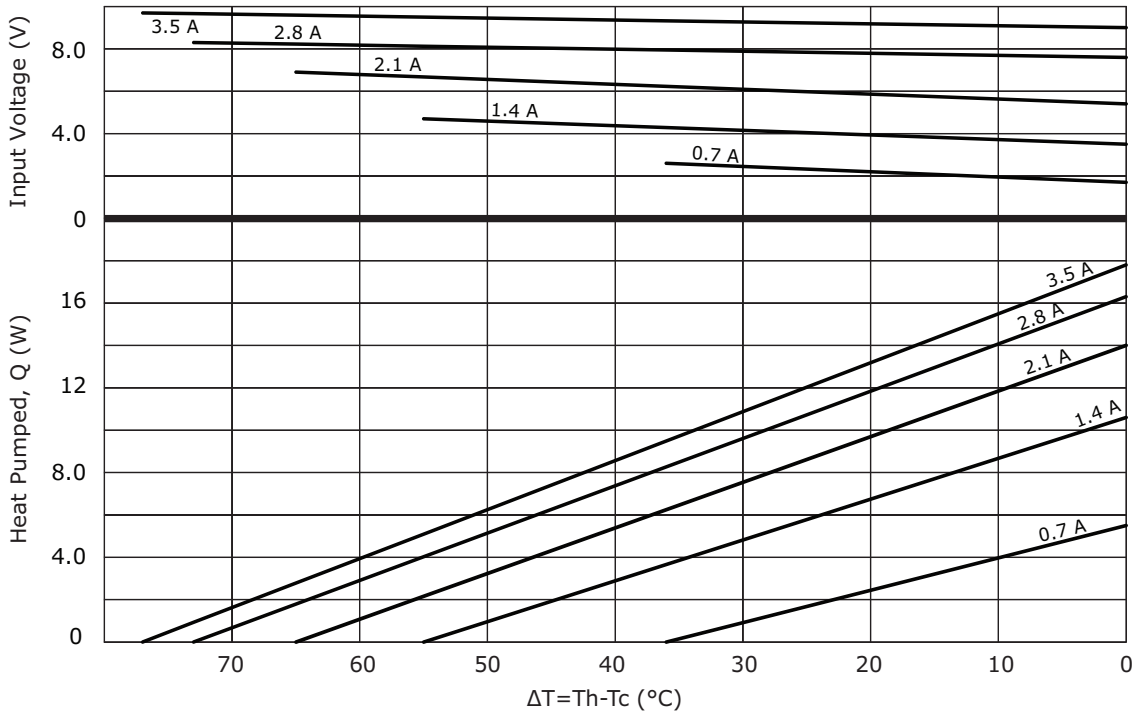

### CP353047 PERFORMANCE (Th=27°C)

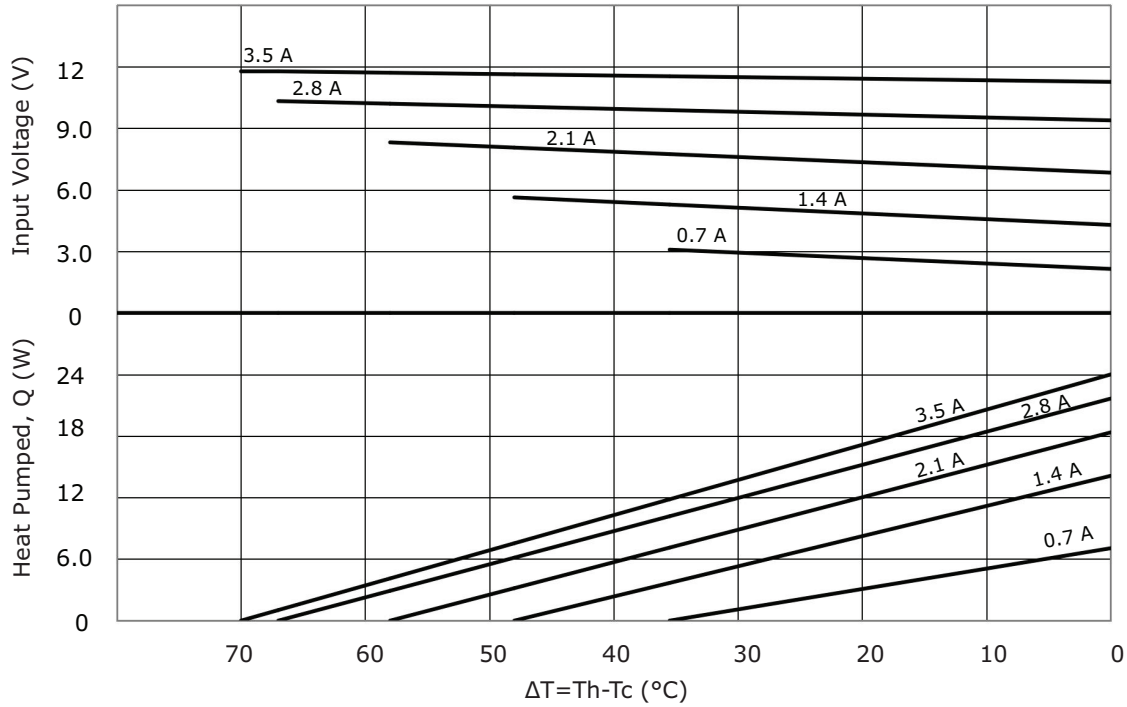

### CP353047 PERFORMANCE (Th=50°C)

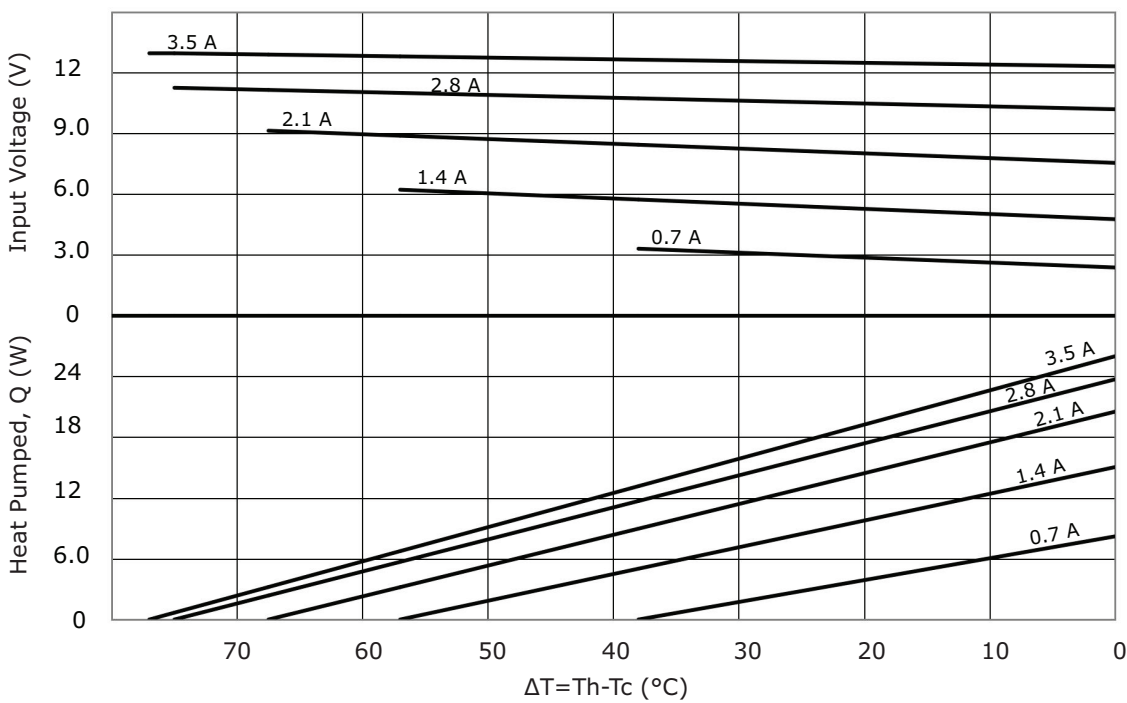

### CP35447 PERFORMANCE (Th=27°C)

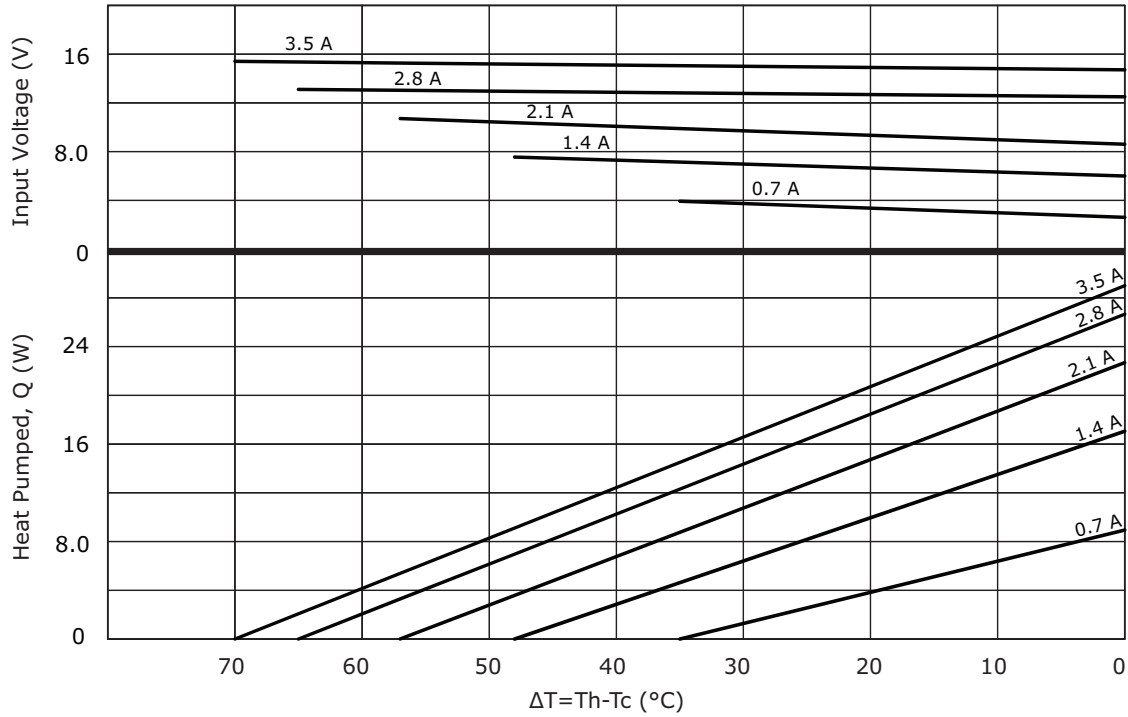

### CP35447 PERFORMANCE (Th=50°C)

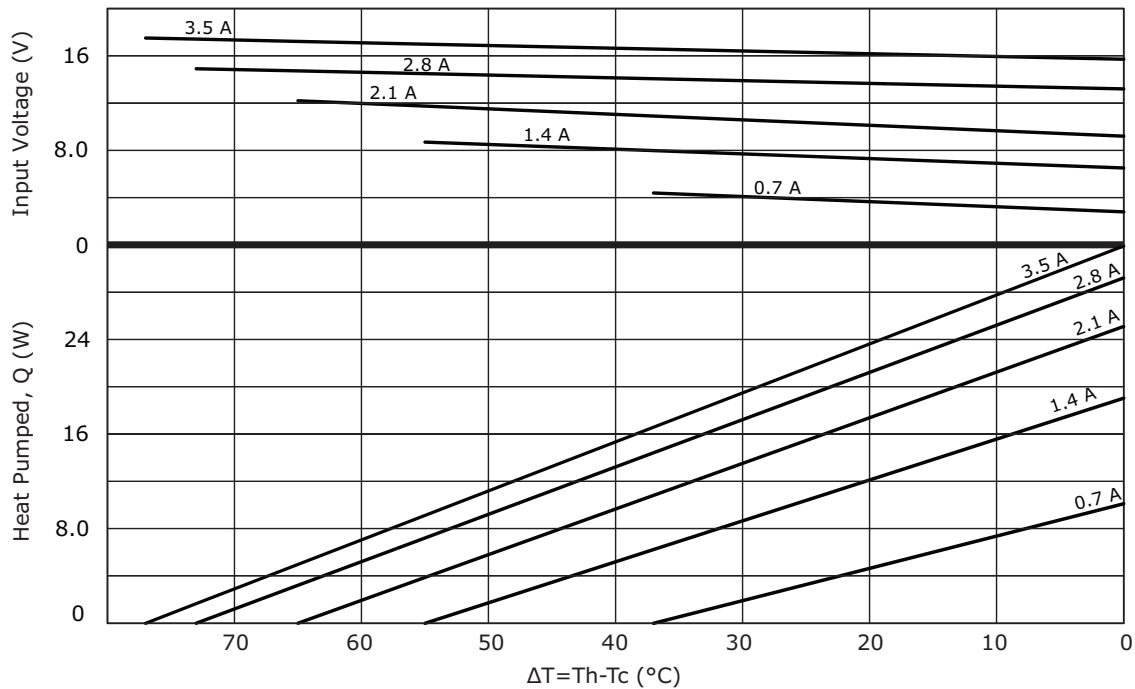



### CP354047 PERFORMANCE (Th=27°C)

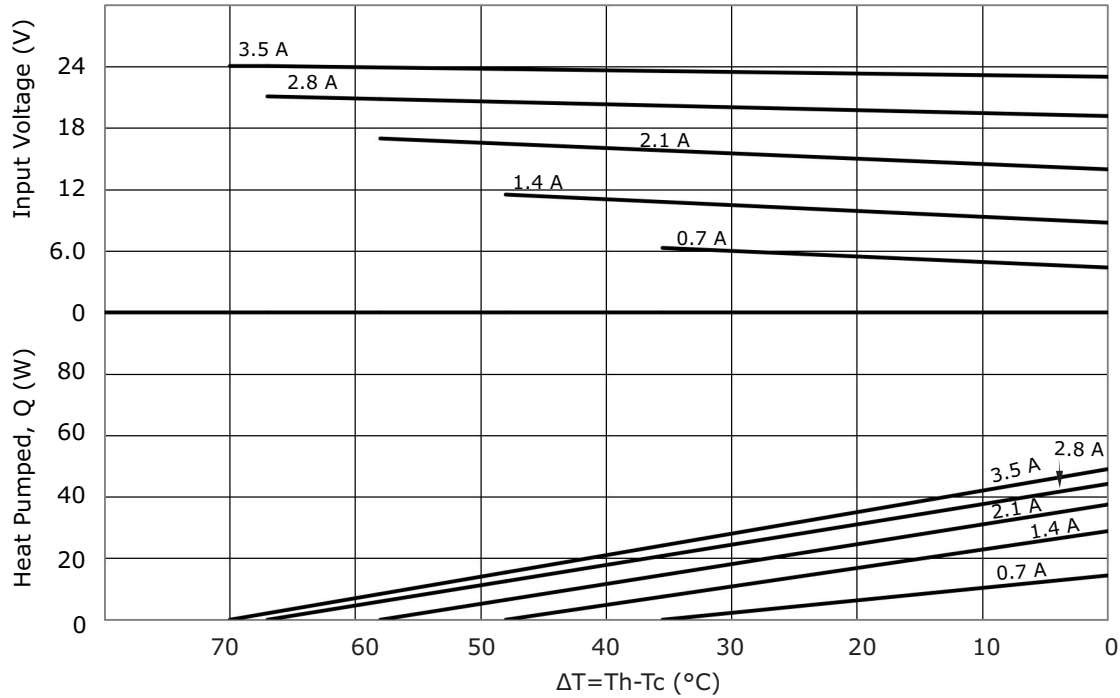

### CP354047 PERFORMANCE (Th=50°C)

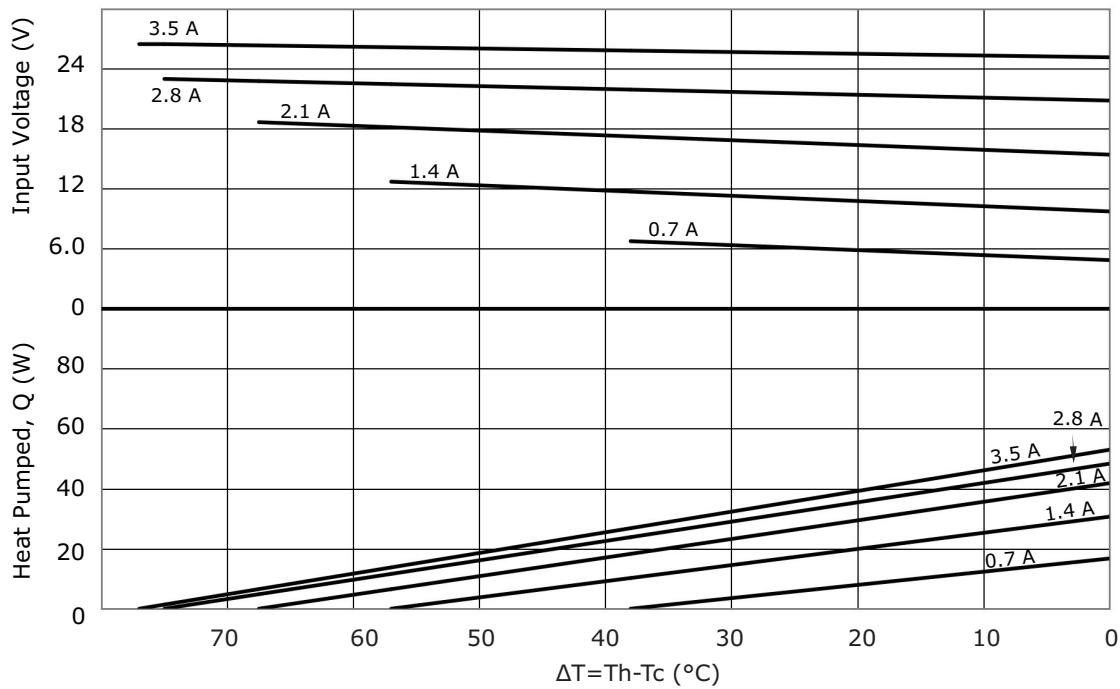

## REVISION HISTORY

---

rev.	description	date
1.0	initial release	09/08/2016
1.01	changed models CP35347 & CP35447 to arcTEC™ structure	12/01/2017
1.02	added models CP353047 & CP354047, brand update	10/18/2019

The revision history provided is for informational purposes only and is believed to be accurate.

---

# CUI DEVICES

CUI Devices offers a one (1) year limited warranty. Complete warranty information is listed on our website.

CUI Devices reserves the right to make changes to the product at any time without notice. Information provided by CUI Devices is believed to be accurate and reliable. However, no responsibility is assumed by CUI Devices for its use, nor for any infringements of patents or other rights of third parties which may result from its use.

CUI Devices products are not authorized or warranted for use as critical components in equipment that requires an extremely high level of reliability. A critical component is any component of a life support device or system whose failure to perform can be reasonably expected to cause the failure of the life support device or system, or to affect its safety or effectiveness.