



ADG611/ADG612/ADG613

FEATURES

- 1 pC charge injection
- ± 2.7 V to ± 5.5 V dual-supply operation
- +2.7 V to +5.5 V single-supply operation
- Automotive temperature range: -40°C to $+125^{\circ}\text{C}$
- 100 pA maximum at 25°C leakage currents
- 85 Ω on resistance
- Rail-to-rail switching operation
- Fast switching times
- 16-lead TSSOP and SOIC packages
- Typical power consumption: <0.1 μW
- TTL-/CMOS-compatible inputs

APPLICATIONS

- Automatic test equipment
- Data acquisition systems
- Battery-powered systems
- Communications systems
- Sample-and-hold systems
- Audio signal routing
- Relay replacement
- Avionics

GENERAL DESCRIPTION

The ADG611/ADG612/ADG613 are monolithic CMOS devices containing four independently selectable switches. These switches offer ultralow charge injection of 1 pC over the full input signal range and typical leakage currents of 10 pA at 25°C .

The devices are fully specified for ± 5 V, +5 V, and +3 V supplies. Each contains four independent single-pole, single-throw (SPST) switches. The ADG611 and ADG612 differ only in that the digital control logic is inverted. The ADG611 switches are turned on with a logic low on the appropriate control input, whereas a logic high is required to turn on the switches of the ADG612. The ADG613 contains two switches with digital control logic similar to that of the ADG611 and two switches in which the logic is inverted.

FUNCTIONAL BLOCK DIAGRAM



NOTES
1. SWITCHES SHOWN FOR A LOGIC 1 INPUT.

Figure 1.

02753-001

Each switch conducts equally well in both directions when on and has an input signal range that extends to the supplies. The ADG613 exhibits break-before-make switching action. The ADG611/ADG612/ADG613 are available in a small, 16-lead TSSOP package, and the ADG611 is also available in a 16-lead SOIC package.

PRODUCT HIGHLIGHTS

1. Ultralow charge injection (1 pC typically).
2. Dual ± 2.7 V to ± 5.5 V or single +2.7 V to +5.5 V operation.
3. Automotive temperature range: -40°C to $+125^{\circ}\text{C}$.
4. Small, 16-lead TSSOP and SOIC packages.

Rev. A

Information furnished by Analog Devices is believed to be accurate and reliable. However, no responsibility is assumed by Analog Devices for its use, nor for any infringements of patents or other rights of third parties that may result from its use. Specifications subject to change without notice. No license is granted by implication or otherwise under any patent or patent rights of Analog Devices. Trademarks and registered trademarks are the property of their respective owners.

TABLE OF CONTENTS

Features	1	Absolute Maximum Ratings	6
Applications.....	1	ESD Caution.....	6
Functional Block Diagram	1	Pin Configuration and Function Descriptions.....	7
General Description	1	Typical Performance Characteristics	8
Product Highlights	1	Terminology	10
Revision History	2	Test Circuits.....	11
Specifications.....	3	Applications Information	13
Dual-Supply Operation	3	Outline Dimensions	14
Single-Supply Operation	4	Ordering Guide	14

REVISION HISTORY

11/09—Rev. 0 to Rev. A

Changes to Analog Signal Range Parameter and to On Resistance, R_{ON} Parameter, Table 1.....	3
Change to Digital Input Capacitance, C_{IN} Parameter, Table 2....	4
Changes to Table 4 and to Absolute Maximum Ratings Section.....	6
Added Table 5; Renumbered Sequentially	7
Updated Outline Dimensions	14
Changes to Ordering Guide	14

1/02—Revision 0: Initial Version

SPECIFICATIONS

DUAL-SUPPLY OPERATION

$V_{DD} = +5\text{ V} \pm 10\%$, $V_{SS} = -5\text{ V} \pm 10\%$, $GND = 0\text{ V}$, unless otherwise noted.

Table 1.

Parameter	+25°C	-40°C to +85°C	-40°C to +125°C ¹	Unit	Test Conditions/Comments
ANALOG SWITCH					
Analog Signal Range			V_{SS} to V_{DD}	V	
On Resistance, R_{ON}	85			Ω typ	$V_S = \pm 3\text{ V}$, $I_S = -1\text{ mA}$; see Figure 14
	115	140	160	Ω max	$V_S = \pm 3\text{ V}$, $I_S = -1\text{ mA}$; see Figure 14
On-Resistance Match Between Channels, ΔR_{ON}	2			Ω typ	$V_S = \pm 3\text{ V}$, $I_S = -1\text{ mA}$
On-Resistance Flatness, $R_{FLAT(ON)}$	4	5.5	6.5	Ω max	$V_S = \pm 3\text{ V}$, $I_S = -1\text{ mA}$
	25			Ω typ	$V_S = \pm 3\text{ V}$, $I_S = -1\text{ mA}$
	40	55	60	Ω max	$V_S = \pm 3\text{ V}$, $I_S = -1\text{ mA}$
LEAKAGE CURRENTS					
Source Off Leakage, $I_{S(OFF)}$	± 0.01			nA typ	$V_{DD} = +5.5\text{ V}$, $V_{SS} = -5.5\text{ V}$ $V_D = \pm 4.5\text{ V}$, $V_S = \mp 4.5\text{ V}$; see Figure 15
	± 0.1	± 0.25	± 2	nA max	$V_D = \pm 4.5\text{ V}$, $V_S = \mp 4.5\text{ V}$; see Figure 15
Drain Off Leakage, $I_{D(OFF)}$	± 0.01			nA typ	$V_D = \pm 4.5\text{ V}$, $V_S = \mp 4.5\text{ V}$; see Figure 15
	± 0.1	± 0.25	± 2	nA max	$V_D = \pm 4.5\text{ V}$, $V_S = \mp 4.5\text{ V}$; see Figure 15
Channel On Leakage, $I_{D(ON)}$, $I_{S(ON)}$	± 0.01			nA typ	$V_D = V_S = \pm 4.5\text{ V}$; see Figure 16
	± 0.1	± 0.25	± 6	nA max	$V_D = V_S = \pm 4.5\text{ V}$; see Figure 16
DIGITAL INPUTS					
Input High Voltage, V_{INH}			2.4	V min	
Input Low Voltage, V_{INL}			0.8	V max	
Input Current, I_{INL} or I_{INH}	0.005			μA typ	$V_{IN} = V_{INL}$ or V_{INH}
			± 0.1	μA max	$V_{IN} = V_{INL}$ or V_{INH}
Digital Input Capacitance, C_{IN}	2			pF typ	
DYNAMIC CHARACTERISTICS²					
t_{ON}	45			ns typ	$R_L = 300\ \Omega$, $C_L = 35\text{ pF}$, $V_S = 3.0\text{ V}$; see Figure 17
	65	75	90	ns max	$R_L = 300\ \Omega$, $C_L = 35\text{ pF}$, $V_S = 3.0\text{ V}$; see Figure 17
t_{OFF}	25			ns typ	$R_L = 300\ \Omega$, $C_L = 35\text{ pF}$, $V_S = 3.0\text{ V}$; see Figure 17
	40	45	50	ns max	$R_L = 300\ \Omega$, $C_L = 35\text{ pF}$, $V_S = 3.0\text{ V}$; see Figure 17
Break-Before-Make Time Delay, t_{BBM}	15			ns typ	$R_L = 300\ \Omega$, $C_L = 35\text{ pF}$, $V_{S1} = V_{S2} = 3.0\text{ V}$; see Figure 18
			10	ns min	$R_L = 300\ \Omega$, $C_L = 35\text{ pF}$, $V_{S1} = V_{S2} = 3.0\text{ V}$; see Figure 18
Charge Injection	-0.5			pC typ	$V_S = 0\text{ V}$, $R_S = 0\ \Omega$, $C_L = 1\text{ nF}$; see Figure 19
Off Isolation	-65			dB typ	$R_L = 50\ \Omega$, $C_L = 5\text{ pF}$, $f = 10\text{ MHz}$; see Figure 20
Channel-to-Channel Crosstalk	-90			dB typ	$R_L = 50\ \Omega$, $C_L = 5\text{ pF}$, $f = 10\text{ MHz}$; see Figure 21
-3 dB Bandwidth	680			MHz typ	$R_L = 50\ \Omega$, $C_L = 5\text{ pF}$; see Figure 22
$C_{S(OFF)}$	5			pF typ	$f = 1\text{ MHz}$
$C_{D(OFF)}$	5			pF typ	$f = 1\text{ MHz}$
$C_{D(ON)}$, $C_{S(ON)}$	5			pF typ	$f = 1\text{ MHz}$
POWER REQUIREMENTS					
I_{DD}	0.001			μA typ	$V_{DD} = +5.5\text{ V}$, $V_{SS} = -5.5\text{ V}$ Digital inputs = 0 V or 5.5 V
			1.0	μA max	Digital inputs = 0 V or 5.5 V
I_{SS}	0.001			μA typ	Digital inputs = 0 V or 5.5 V
			1.0	μA max	Digital inputs = 0 V or 5.5 V

¹ The temperature range for the Y version is -40°C to +125°C.

² Guaranteed by design; not subject to production test.

ADG611/ADG612/ADG613

SINGLE-SUPPLY OPERATION

$V_{DD} = 5\text{ V} \pm 10\%$, $V_{SS} = 0\text{ V}$, $GND = 0\text{ V}$, unless otherwise noted.

Table 2.

Parameter	+25°C	−40°C to +85°C	−40°C to +125°C ¹	Unit	Test Conditions/Comments
ANALOG SWITCH					
Analog Signal Range			0 to V_{DD}	V	
On Resistance, R_{ON}	210			Ω typ	$V_S = 3.5\text{ V}$, $I_S = -1\text{ mA}$; see Figure 14
	290	350	380	Ω max	$V_S = 3.5\text{ V}$, $I_S = -1\text{ mA}$; see Figure 14
On-Resistance Match Between Channels, ΔR_{ON}	3			Ω typ	$V_S = 3.5\text{ V}$, $I_S = -1\text{ mA}$
	10	12	13	Ω max	$V_S = 3.5\text{ V}$, $I_S = -1\text{ mA}$
LEAKAGE CURRENTS					
Source Off Leakage, $I_{S(OFF)}$	± 0.01			nA typ	$V_{DD} = 5.5\text{ V}$ $V_S = 1\text{ V}/4.5\text{ V}$, $V_D = 4.5\text{ V}/1\text{ V}$; see Figure 15
	± 0.1	± 0.25	± 2	nA max	$V_S = 1\text{ V}/4.5\text{ V}$, $V_D = 4.5\text{ V}/1\text{ V}$; see Figure 15
Drain Off Leakage, $I_{D(OFF)}$	± 0.01			nA typ	$V_S = 1\text{ V}/4.5\text{ V}$, $V_D = 4.5\text{ V}/1\text{ V}$; see Figure 15
	± 0.1	± 0.25	± 2	nA max	$V_S = 1\text{ V}/4.5\text{ V}$, $V_D = 4.5\text{ V}/1\text{ V}$; see Figure 15
Channel On Leakage, $I_{D(ON)}$, $I_{S(ON)}$	± 0.01			nA typ	$V_S = V_D = 1\text{ V}$ or 4.5 V ; see Figure 16
	± 0.1	± 0.25	± 6	nA max	$V_S = V_D = 1\text{ V}$ or 4.5 V ; see Figure 16
DIGITAL INPUTS					
Input High Voltage, V_{INH}			2.4	V min	
Input Low Voltage, V_{INL}			0.8	V max	
Input Current, I_{INL} or I_{INH}	0.005			μA typ	$V_{IN} = V_{INL}$ or V_{INH}
			± 0.1	μA max	$V_{IN} = V_{INL}$ or V_{INH}
Digital Input Capacitance, C_{IN}	2			pF typ	
DYNAMIC CHARACTERISTICS²					
t_{ON}	70			ns typ	$R_L = 300\ \Omega$, $C_L = 35\text{ pF}$, $V_S = 3.0\text{ V}$; see Figure 17
	100	130	150	ns max	$R_L = 300\ \Omega$, $C_L = 35\text{ pF}$, $V_S = 3.0\text{ V}$; see Figure 17
t_{OFF}	25			ns typ	$R_L = 300\ \Omega$, $C_L = 35\text{ pF}$, $V_S = 3.0\text{ V}$; see Figure 17
	40	45	50	ns max	$R_L = 300\ \Omega$, $C_L = 35\text{ pF}$, $V_S = 3.0\text{ V}$; see Figure 17
Break-Before-Make Time Delay, t_{BBM}	25			ns typ	$R_L = 300\ \Omega$, $C_L = 35\text{ pF}$, $V_{S1} = V_{S2} = 3.0\text{ V}$; see Figure 18
			10	ns min	$R_L = 300\ \Omega$, $C_L = 35\text{ pF}$, $V_{S1} = V_{S2} = 3.0\text{ V}$; see Figure 18
Charge Injection	1			pC typ	$V_S = 0\text{ V}$, $R_S = 0\ \Omega$, $C_L = 1\text{ nF}$; see Figure 19
Off Isolation	−62			dB typ	$R_L = 50\ \Omega$, $C_L = 5\text{ pF}$, $f = 10\text{ MHz}$; see Figure 20
Channel-to-Channel Crosstalk	−90			dB typ	$R_L = 50\ \Omega$, $C_L = 5\text{ pF}$, $f = 10\text{ MHz}$; see Figure 21
−3 dB Bandwidth	680			MHz typ	$R_L = 50\ \Omega$, $C_L = 5\text{ pF}$; see Figure 22
$C_{S(OFF)}$	5			pF typ	$f = 1\text{ MHz}$
$C_{D(OFF)}$	5			pF typ	$f = 1\text{ MHz}$
$C_{D(ON)}$, $C_{S(ON)}$	5			pF typ	$f = 1\text{ MHz}$
POWER REQUIREMENTS					
I_{DD}	0.001			μA typ	$V_{DD} = 5.5\text{ V}$ Digital inputs = 0 V or 5.5 V
			1.0	μA max	Digital inputs = 0 V or 5.5 V

¹ The temperature range for the Y version is -40°C to $+125^\circ\text{C}$.

² Guaranteed by design; not subject to production test.

$V_{DD} = 3\text{ V} \pm 10\%$, $V_{SS} = 0\text{ V}$, $GND = 0\text{ V}$, unless otherwise noted.

Table 3.

Parameter	+25°C	-40°C to +85°C	-40°C to +125°C ¹	Unit	Test Conditions/Comments
ANALOG SWITCH					
Analog Signal Range			0 to V_{DD}	V	
On Resistance, R_{ON}	380	420	460	Ω typ	$V_S = 1.5\text{ V}$, $I_S = -1\text{ mA}$; see Figure 14
LEAKAGE CURRENTS					
Source Off Leakage, $I_{S(OFF)}$	± 0.01			nA typ	$V_{DD} = 3.3\text{ V}$ $V_S = 1\text{ V}/3\text{ V}$, $V_D = 3\text{ V}/1\text{ V}$; see Figure 15
	± 0.1	± 0.25	± 2	nA max	$V_S = 1\text{ V}/3\text{ V}$, $V_D = 3\text{ V}/1\text{ V}$; see Figure 15
Drain Off Leakage, $I_{D(OFF)}$	± 0.01			nA typ	$V_S = 1\text{ V}/3\text{ V}$, $V_D = 3\text{ V}/1\text{ V}$; see Figure 15
	± 0.1	± 0.25	± 2	nA max	$V_S = 1\text{ V}/3\text{ V}$, $V_D = 3\text{ V}/1\text{ V}$; see Figure 15
Channel On Leakage, $I_{D(ON)}$, $I_{S(ON)}$	± 0.01			nA typ	$V_S = V_D = 1\text{ V}$ or 3 V ; see Figure 16
	± 0.1	± 0.25	± 6	nA max	$V_S = V_D = 1\text{ V}$ or 3 V ; see Figure 16
DIGITAL INPUTS					
Input High Voltage, V_{INH}			2.0	V min	
Input Low Voltage, V_{INL}			0.8	V max	
Input Current, I_{INL} or I_{INH}	0.005			μA typ	$V_{IN} = V_{INL}$ or V_{INH}
			± 0.1	μA max	$V_{IN} = V_{INL}$ or V_{INH}
Digital Input Capacitance, C_{IN}	2			pF typ	
DYNAMIC CHARACTERISTICS²					
t_{ON}	130			ns typ	$R_L = 300\ \Omega$, $C_L = 35\text{ pF}$, $V_S = 2\text{ V}$; see Figure 17
	185	230	260	ns max	$R_L = 300\ \Omega$, $C_L = 35\text{ pF}$, $V_S = 2\text{ V}$; see Figure 17
t_{OFF}	40			ns typ	$R_L = 300\ \Omega$, $C_L = 35\text{ pF}$, $V_S = 2\text{ V}$; see Figure 17
	55	60	65	ns max	$R_L = 300\ \Omega$, $C_L = 35\text{ pF}$, $V_S = 2\text{ V}$; see Figure 17
Break-Before-Make Time Delay, t_{BBM}	50			ns typ	$R_L = 300\ \Omega$, $C_L = 35\text{ pF}$, $V_{S1} = V_{S2} = 2\text{ V}$; see Figure 18
			10	ns min	$R_L = 300\ \Omega$, $C_L = 35\text{ pF}$, $V_{S1} = V_{S2} = 2\text{ V}$; see Figure 18
Charge Injection	1.5			pC typ	$V_S = 0\text{ V}$, $R_S = 0\ \Omega$, $C_L = 1\text{ nF}$; see Figure 19
Off Isolation	-62			dB typ	$R_L = 50\ \Omega$, $C_L = 5\text{ pF}$, $f = 10\text{ MHz}$; see Figure 20
Channel-to-Channel Crosstalk	-90			dB typ	$R_L = 50\ \Omega$, $C_L = 5\text{ pF}$, $f = 10\text{ MHz}$; see Figure 21
-3 dB Bandwidth	680			MHz typ	$R_L = 50\ \Omega$, $C_L = 5\text{ pF}$; see Figure 22
$C_{S(OFF)}$	5			pF typ	$f = 1\text{ MHz}$
$C_{D(OFF)}$	5			pF typ	$f = 1\text{ MHz}$
$C_{D(ON)}$, $C_{S(ON)}$	5			pF typ	$f = 1\text{ MHz}$
POWER REQUIREMENTS					
I_{DD}	0.001			μA typ	$V_{DD} = 3.3\text{ V}$ Digital inputs = 0 V or 3.3 V
			1.0	μA max	Digital inputs = 0 V or 3.3 V

¹ The temperature range for the Y version is -40°C to +125°C.

² Guaranteed by design; not subject to production test.

ADG611/ADG612/ADG613

ABSOLUTE MAXIMUM RATINGS

T_A = 25°C, unless otherwise noted

Table 4.

Parameter	Rating
V _{DD} to V _{SS}	13 V
V _{DD} to GND	-0.3 V to +6.5 V
V _{SS} to GND	+0.3 V to -6.5 V
Analog Inputs ¹	V _{SS} - 0.3 V to V _{DD} + 0.3 V
Digital Inputs ¹	GND - 0.3 V to V _{DD} + 0.3 V or 30 mA, whichever occurs first
Peak Current, S or D	20 mA (pulsed at 1 ms, 10% duty cycle maximum)
Continuous Current, S or D	10 mA
3 V operation 85°C to 125°C	7.5 mA
Operating Temperature Range Automotive (Y Version)	-40°C to +125°C
Storage Temperature Range	-65°C to +150°C
Junction Temperature	150°C
θ _{JA} Thermal Impedance	
16-Lead TSSOP	150.4°C/W
16-Lead SOIC, 4-Layer Board	80.6°C/W
Lead Soldering	
Lead Temperature, Soldering (10 sec)	300°C
IR Reflow, Peak Temperature (<20 sec)	220°C
(Pb-Free) Soldering	
Reflow, Peak Temperature	260(+0/-5)°C
Time at Peak Temperature	20 sec to 40 sec

¹Overvoltages at IN, S, or D are clamped by internal diodes. The current should be limited to the maximum ratings given.

Stresses above those listed under Absolute Maximum Ratings may cause permanent damage to the device. This is a stress rating only; functional operation of the device at these or any other conditions above those indicated in the operational section of this specification is not implied. Exposure to absolute maximum rating conditions for extended periods may affect device reliability.

Only one absolute maximum rating can be applied at any one time.

ESD CAUTION



ESD (electrostatic discharge) sensitive device. Charged devices and circuit boards can discharge without detection. Although this product features patented or proprietary protection circuitry, damage may occur on devices subjected to high energy ESD. Therefore, proper ESD precautions should be taken to avoid performance degradation or loss of functionality.

PIN CONFIGURATION AND FUNCTION DESCRIPTIONS

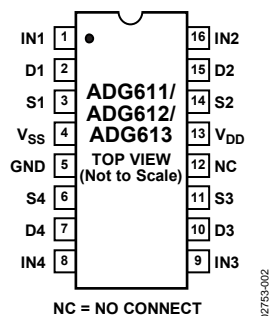

Figure 2. Pin Configuration

Table 5. Pin Function Descriptions

Pin No.	Mnemonic	Description
1	IN1	Switch 1 Digital Control Input.
2	D1	Drain Terminal of Switch 1. Can be an input or output.
3	S1	Source Terminal of Switch 1. Can be an input or output.
4	V _{SS}	Most Negative Power Supply Terminal. Tie this pin to GND when using the device with single-supply voltages.
5	GND	Ground (0 V) Reference.
6	S4	Source Terminal of Switch 4. Can be an input or output.
7	D4	Drain Terminal of Switch 4. Can be an input or output.
8	IN4	Switch 4 Digital Control Input.
9	IN3	Switch 3 Digital Control Input.
10	D3	Drain Terminal of Switch 3. Can be an input or output.
11	S3	Source Terminal of Switch 3. Can be an input or output.
12	NC	Not Internally Connected.
13	V _{DD}	Most Positive Power Supply Terminal.
14	S2	Source Terminal of Switch 2. Can be an input or output.
15	D2	Drain Terminal of Switch 2. Can be an input or output.
16	IN2	Switch 2 Digital Control Input.

Table 6. ADG611/ADG612 Truth Table

ADG611 Input	ADG612 Input	Switch Condition
0	1	On
1	0	Off

Table 7. ADG613 Truth Table

Logic	Switch 1, Switch 4	Switch 2, Switch 3
0	Off	On
1	On	Off

TYPICAL PERFORMANCE CHARACTERISTICS



Figure 3. On Resistance vs. V_D (V_S), Dual Supplies



Figure 6. On Resistance vs. V_D (V_S) for Various Temperatures, Single Supply



Figure 4. On Resistance vs. V_D (V_S), Single Supply



Figure 7. Leakage Current vs. Temperature, Dual Supplies



Figure 5. On Resistance vs. V_D (V_S) for Various Temperatures, Dual Supplies



Figure 8. Leakage Current vs. Temperature, Single Supply



Figure 9. Charge Injection vs. Source Voltage



Figure 12. Off Isolation vs. Frequency

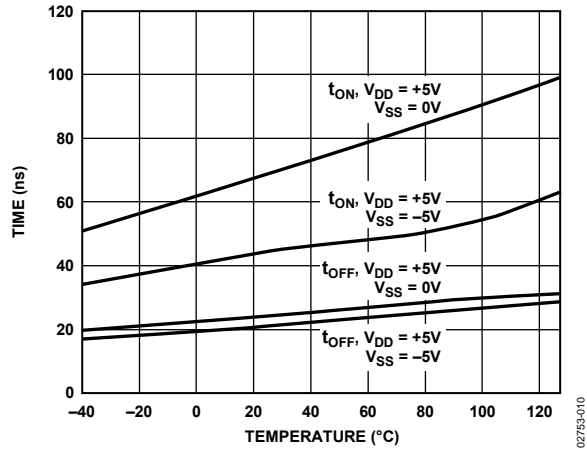

Figure 10. t_{ON}/t_{OFF} Times vs. Temperature

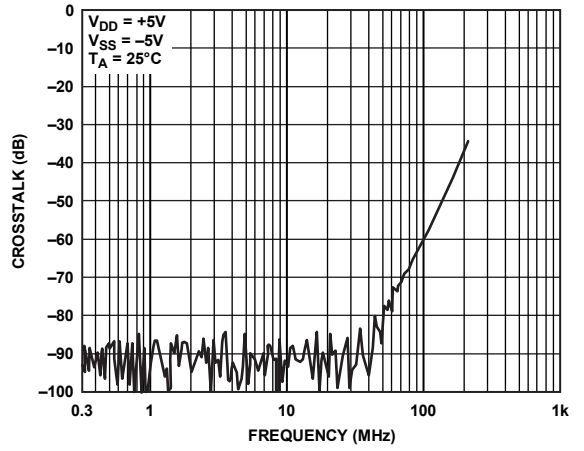

Figure 13. Crosstalk vs. Frequency

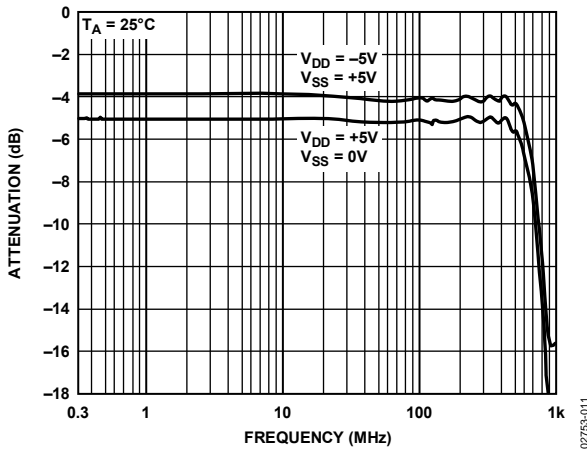

Figure 11. On Response vs. Frequency

TERMINOLOGY

V_{DD} Most positive power supply potential.	V_{INH} Minimum input voltage for Logic 1.
V_{SS} Most negative power supply potential.	I_{INL}, I_{INH} Input current of the digital input.
I_{DD} Positive supply current.	C_{S(OFF)} Off switch source capacitance. Measured with reference to ground.
I_{SS} Negative supply current.	C_{D(OFF)} Off switch drain capacitance. Measured with reference to ground.
GND Ground (0 V) reference.	C_{D(ON)}, C_{S(ON)} On switch capacitance. Measured with reference to ground.
S Source terminal. Can be an input or output.	C_{IN} Digital input capacitance.
D Drain terminal. Can be an input or output.	t_{ON} Delay between applying the digital control input and the output switching on (see Figure 17).
IN Logic control input.	t_{OFF} Delay between applying the digital control input and the output switching off (see Figure 17).
V_D (V_S) Analog voltage on Terminal D and Terminal S.	Charge Injection A measure of the glitch impulse transferred from the digital input to the analog output during switching.
R_{ON} Ohmic resistance between Terminal D and Terminal S.	Off Isolation A measure of unwanted signal coupling through an off switch.
ΔR_{ON} On-resistance match between any two channels, that is, R _{ONMAX} – R _{ONMIN} .	Crosstalk A measure of unwanted signal that is coupled through from one channel to another as a result of parasitic capacitance.
R_{FLAT(ON)} Flatness is defined as the difference between the maximum and minimum value of on resistance as measured over the specified analog signal range.	On Response Frequency response of the on switch.
I_{S(OFF)} Source leakage current with the switch off.	Insertion Loss Loss due to the on resistance of the switch.
I_{D(OFF)} Drain leakage current with the switch off.	
I_{D(ON)}, I_{S(ON)} Channel leakage current with the switch on.	
V_{INL} Maximum input voltage for Logic 0.	

TEST CIRCUITS



Figure 14. On Resistance

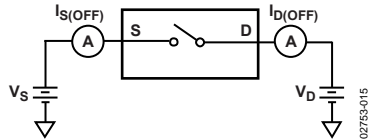

Figure 15. Off Leakage

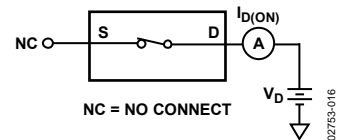

Figure 16. On Leakage



Figure 17. Switching Times



Figure 18. Break-Before-Make Time Delay



Figure 19. Charge Injection

ADG611/ADG612/ADG613



$$\text{OFF ISOLATION} = 20 \log \frac{V_{\text{OUT}}}{V_s}$$

02753-020

Figure 20. Off Isolation

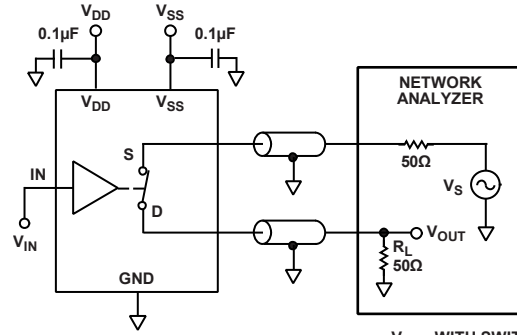

$$\text{INSERTION LOSS} = 20 \log \frac{V_{\text{OUT WITH SWITCH}}}{V_{\text{OUT WITHOUT SWITCH}}}$$

02753-022

Figure 22. Bandwidth



$$\text{CHANNEL-TO-CHANNEL CROSSTALK} = 20 \log |V_s/V_{\text{OUT}}|$$

02753-021

Figure 21. Channel-to-Channel Crosstalk

APPLICATIONS INFORMATION

Figure 23 illustrates a photodetector circuit with programmable gain. With the resistor values shown in this figure, gains in the range of 2 to 16 can be achieved by using different combinations of switches.



Figure 23. Photodetector Circuit with Programmable Gain

02753-023

ADG611/ADG612/ADG613

OUTLINE DIMENSIONS



COMPLIANT TO JEDEC STANDARDS MO-153-AB

Figure 24. 16-Lead Thin Shrink Small Outline Package [TSSOP]
(RU-16)

Dimensions shown in millimeters



COMPLIANT TO JEDEC STANDARDS MS-012-AC

CONTROLLING DIMENSIONS ARE IN MILLIMETERS; INCH DIMENSIONS
(IN PARENTHESES) ARE ROUNDED-OFF MILLIMETER EQUIVALENTS FOR
REFERENCE ONLY AND ARE NOT APPROPRIATE FOR USE IN DESIGN.

Figure 25. 16-Lead Standard Small Outline Package [SOIC_N]

Narrow Body

(R-16)

Dimensions shown in millimeters and (inches)

060606-A

ORDERING GUIDE

Model	Temperature Range	Package Description	Package Option
ADG611YRUZ ¹	-40°C to +125°C	16-Lead Thin Shrink Small Outline Package [TSSOP]	RU-16
ADG611YRUZ-REEL ¹	-40°C to +125°C	16-Lead Thin Shrink Small Outline Package [TSSOP]	RU-16
ADG611YRUZ-REEL7 ¹	-40°C to +125°C	16-Lead Thin Shrink Small Outline Package [TSSOP]	RU-16
ADG611YRZ ¹	-40°C to +125°C	16-Lead Standard Small Outline Package [SOIC_N]	R-16
ADG612YRUZ ¹	-40°C to +125°C	16-Lead Thin Shrink Small Outline Package [TSSOP]	RU-16
ADG612YRUZ-REEL ¹	-40°C to +125°C	16-Lead Thin Shrink Small Outline Package [TSSOP]	RU-16
ADG612YRUZ-REEL7 ¹	-40°C to +125°C	16-Lead Thin Shrink Small Outline Package [TSSOP]	RU-16
ADG612WRUZ-REEL ¹	-40°C to +125°C	16-Lead Thin Shrink Small Outline Package [TSSOP]	RU-16
ADG613YRUZ ¹	-40°C to +125°C	16-Lead Thin Shrink Small Outline Package [TSSOP]	RU-16
ADG613YRUZ-REEL ¹	-40°C to +125°C	16-Lead Thin Shrink Small Outline Package [TSSOP]	RU-16
ADG613YRUZ-REEL7 ¹	-40°C to +125°C	16-Lead Thin Shrink Small Outline Package [TSSOP]	RU-16

¹ Z = RoHS Compliant Part.

NOTES

NOTES