

Description

The F0448 is a 3.4GHz to 3.8GHz dual RF digital variable gain amplifier (DVGA) designed for use in receivers.

This dual RF DVGA provides two independent receiver channels each with 13dB typical maximum gain and 6dB noise figure designed to operate with a single +5V supply. For each channel, gain control is split into three separate attenuators: DSA0, a single 6dB step using a single control pin; DSA1, a 23dB SPI-controlled gain adjustment in 1dB steps; and DSA2, includes 18dB attenuation in 6dB steps controlled using two control pins. The F0448 offers +37dBm nominal output IP3 using 220mA total I_{CC} .

This device is packaged in a 6×6 mm, 36-QFN with 50Ω single-ended RF input and RF output impedances for ease of integration into the signal-channel lineup for each of the two channels.

Competitive Advantage

- High reliability
- High linearity
- Low DC current
- *Zero Distortion™* technology
- *GlitchFree™* technology

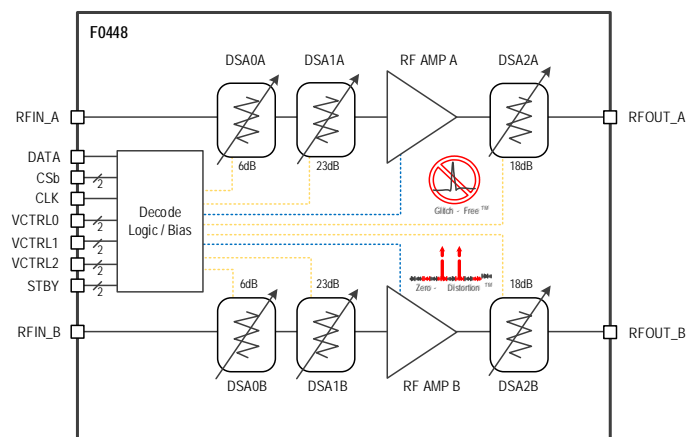
Typical Applications

- Multi-mode, Multi-carrier Receivers
- PHS/PAS Base Stations
- Distributed Antenna Systems
- Digital Radio

Features

- RF Frequency Range: 3.4GHz to 3.8GHz
- Dual Channel RF amp and DSAs for Diversity / MIMO Receivers
- < 2dB overshoot between DSA transitions
- 13dB typical maximum gain at 3.6GHz
- DSA0: Single 6dB coarse step
- DSA1: 23dB total gain range in 1dB steps
- DSA2: 18dB gain range in 6dB steps
- +37dBm OIP3 at 3.6GHz
- 6dB Noise figure at 3.6GHz
- +5V Supply voltage
- $I_{CC} = 220$ mA
- Independent standby: 7mA standby current
- SPI interface for DSA1
- 1-bit control for DSA0
- 2-bit control for DSA2
- 50Ω input and output impedance
- Internally matched
- Temperature range: -40°C to $+105^{\circ}\text{C}$
- $6 \times 6 \times 0.75$ mm 36-QFN package

Block Diagram



Contents

Pin Assignments.....	5
Pin Descriptions.....	6
Absolute Maximum Ratings.....	7
Recommended Operating Conditions	7
Electrical Characteristics	8
Thermal Characteristics.....	11
Typical Operating Conditions (TOC)	11
Typical Performance Characteristics.....	12
Programming.....	18
Serial Control – DSA1	18
Parallel Control Mode – DSA0, DSA2, STBY	21
Typical Application Circuit	22
Evaluation Kit Picture	23
Evaluation Kit / Applications Circuit	24
Evaluation Kit Operation.....	26
Power Supply Setup.....	26
GND Jumpers.....	26
Standby (STBY) Pin	27
Serial Control.....	28
Parallel Control Pins.....	29
Power-On Procedure.....	29
Power-Off Procedure.....	29
Application Information	30
Power Supplies.....	30
RSET and RDSET	30
Control Pin Interface.....	30
Package Outline Drawings	31
Marking Diagram	31
Ordering Information.....	31
Revision History.....	32

List of Figures

Figure 1. Pin Assignments for 6 × 6 mm 32-QFN – Top View.....	5
Figure 2. Maximum Gain vs. Frequency.....	12
Figure 3. Gain vs. Frequency for DSA0 Settings.....	12
Figure 4. Gain vs. Frequency for DSA1 Settings.....	12
Figure 5. Gain vs. Frequency for DSA2 Settings.....	12
Figure 6. Stability vs. Frequency as a Function of Voltage and Temperature.....	12
Figure 7. Input Return Loss for DSA0 Settings.....	13
Figure 8. Output Return Loss for DSA0 Settings.....	13
Figure 9. Input Return Loss for DSA1 Settings.....	13
Figure 10. Output Return Loss for DSA1 Settings.....	13
Figure 11. Input Return Loss for DSA2 Settings.....	13
Figure 12. Output Return Loss for DSA2 Settings.....	13
Figure 13. Reverse Location for DSA0 Settings.....	14
Figure 14. Phase Deviation Between Adjacent States vs. DSA0 Setting.....	14
Figure 15. Reverse Location for DSA1 Settings.....	14
Figure 16. Phase Deviation Between Adjacent States vs. DSA1 Setting.....	14
Figure 17. Reverse Location for DSA2 Settings.....	14
Figure 18. Phase Deviation Between Adjacent States vs. DSA2 Setting.....	14
Figure 19. DSA0 Absolute Attenuation Error (INL).....	15
Figure 20. DSA0 Attenuator Step Error (DNL).....	15
Figure 21. DSA1 Absolute Attenuation Error (INL).....	15
Figure 22. DSA1 Attenuator Step Error (DNL).....	15
Figure 23. DSA2 Absolute Attenuation Error (INL).....	15
Figure 24. DSA2 Attenuator Step Error (DNL).....	15
Figure 25. OIP3 vs. Frequency with $P_{OUT} = 0\text{dBm/Tone}$ and Max Gain.....	16
Figure 26. OIP3 vs. Frequency with $P_{OUT} = -10\text{dBm/Tone}$ and Max Gain.....	16
Figure 27. OIP3 vs. Frequency with $P_{OUT} = -18\text{dBm/Tone}$ and DSA2 = 18dB.....	16
Figure 28. OIP3 vs. Frequency as a Function of Tone Spacing with $P_{OUT} = 0\text{dBm/Tone}$	16
Figure 29. OIP3 vs. Frequency with $P_{OUT} = 0\text{dBm/Tone}$ and DSA0 = 6dB.....	16
Figure 30. Wideband OIP2 vs. Frequency with $P_{OUT} = -10\text{dBm/Tone}$	17
Figure 31. Wideband OIP2 vs. Frequency with $P_{OUT} = 0\text{dBm/Tone}$	17
Figure 32. NF vs. Frequency as a Function of Temperature at Max Gain.....	17
Figure 33. NF vs. Frequency as a Function of Temperature with DSA1 = 22dB.....	17
Figure 34. Gain Compression at $f_{RF} = 3.6\text{GHz}$	17
Figure 35. EVKit Connector and Trace Losses.....	17
Figure 36. Serial Register Data Flow Diagram (LSB Clock in First).....	18
Figure 37. DSA1 Default Condition.....	18
Figure 38. Serial Timing Diagram.....	20
Figure 39. Electrical Schematic.....	22
Figure 40. Top View.....	23

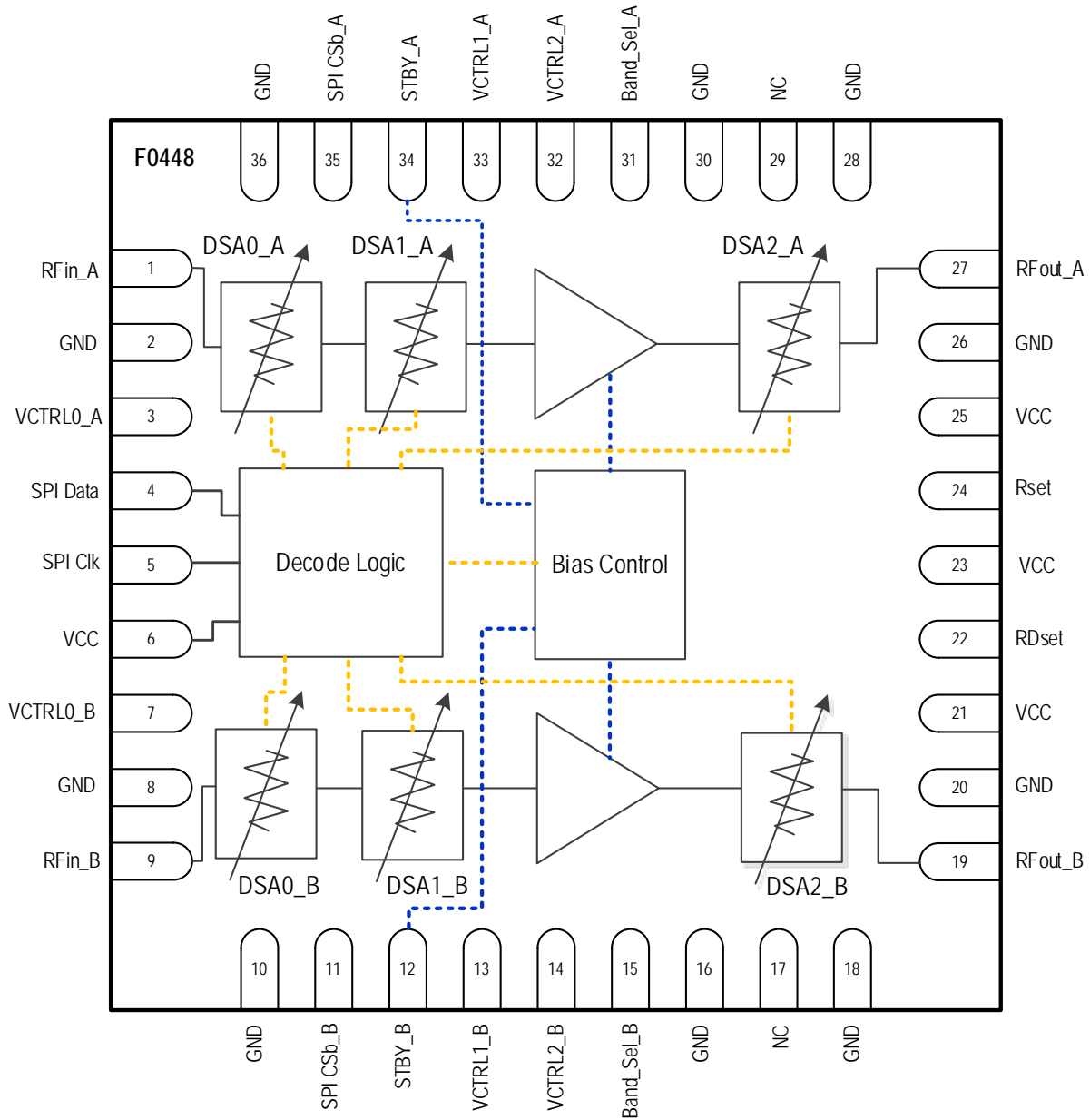
Figure 41. Bottom View	23
Figure 42. Electrical Schematic	24
Figure 43. Power Supply Connections – Top View.....	26
Figure 44. Power Supply Connections – Bottom View	26
Figure 45. Two Ground Jumper Connections.....	26
Figure 46. Two Standby Pin Connections	27
Figure 47. Two Jumpers for Serial Programming Connections	28
Figure 48. Parallel Pin Connections	29
Figure 49. Control Pin Interface.....	30

List of Tables

Table 1. Pin Descriptions.....	6
Table 2. Absolute Maximum Ratings.....	7
Table 3. Recommended Operating Conditions	7
Table 4. Electrical Characteristics	8
Table 5. Package Thermal Characteristics.....	11
Table 6. DSA1 Attenuation Word Truth Table (LSB = First In).....	19
Table 7. SPI Timing Diagram Values for Figure 38.....	20
Table 8. DSA0 Truth Table.....	21
Table 9. DSA2 Truth Table.....	21
Table 10. STANDBY Truth Table	21
Table 11. Bill of Material (BOM)	25
Table 12. J13 Header Pins.....	28
Table 13. Attenuator Control Using One Latch Signal.....	29

Pin Assignments

Figure 1. Pin Assignments for 6 x 6 mm 32-QFN – Top View



Pin Descriptions

Table 1. Pin Descriptions

Number	Name	Description
1	RFIN_A	Input RF port for channel A which is internally matched to 50Ω. Must use external DC block.
2, 8, 15, 16, 17, 29, 30, 31	GND	Internally grounded. This pin must be grounded with a via as close to the pin as possible.
3	VCTRL0_A	1-bit DSA0 6dB attenuator control for channel A. Logic HIGH is for 6dB attenuated and logic LOW is for 0dB attenuated.
4	DATA	Data input: 3.3V or 1.8V CMOS compatible.
5	CLK	Clock input: 3.3V or 1.8V CMOS compatible.
6, 21, 23, 25	V _{CC}	Power Supply. Use bypass capacitors as close to pin as possible.
7	VCTRL0_B	1-bit DSA0 6dB attenuator control for channel B. Logic HIGH is for 6dB attenuated and logic LOW is for 0dB attenuated.
9	RFIN_B	Input RF port for channel B that is internally matched to 50Ω. Must use external DC block.
10, 18, 20, 26, 28, 36	NC	No internal connection. These pins can be left unconnected or be connected to ground (recommended). Use a via as close to the pin as possible if grounded.
11	CSb_B	Chip Select bar input for channel B: 3.3V or 1.8V CMOS compatible. Logic LOW allows data to be shifted in.
12	STBY_B	Standby pin for channel B (LOW/Open = device power ON, HIGH = device power OFF with SPI still powered ON). An internal pull-down resistor of 57kΩ connects between this pin and GND.
13	VCTRL1_B	Bit 0 for DSA2 channel B attenuator. Logic HIGH is for 6dB attenuated and logic LOW is for 0dB attenuated.
14	VCTRL2_B	Bit 1 for DSA2 channel B attenuator. Logic HIGH is for 12dB attenuated and logic LOW is for 0dB attenuated.
19	RFOUT_B	Output RF port for channel B. Use external DC block as close to the pin as possible.
22	RDSET	Connect external resistor to GND to optimize amplifier bias. Used with pin 24.
24	RSET	Connect external resistor to GND to optimize amplifier bias. Used with pin 22.
27	RFOUT_A	Output RF port for channel A. Use external DC block as close to the pin as possible.
32	VCTRL2_A	Bit 1 for DSA2 channel A attenuator. Logic HIGH is for 12dB attenuated and logic LOW is for 0dB attenuated.
33	VCTRL1_A	Bit 0 for DSA2 channel A attenuator. Logic HIGH is for 6dB attenuated and logic LOW is for 0dB attenuated.
34	STBY_A	Standby pin for channel A (LOW/Open = device power ON, HIGH = device power OFF with SPI still powered ON). An internal pull-down resistor of 57kΩ connects between this pin and GND.
35	CSb_A	Chip Select bar input for channel A: 3.3V or 1.8V CMOS compatible. Logic LOW allows data to be shifted in.
	— EPAD	Exposed paddle. Internally connected to ground. Solder this exposed paddle to a printed circuit board (PCB) pad that uses multiple ground vias to provide heat transfer out of the device into the PCB ground planes. These multiple ground vias are also required to achieve the specified RF performance.

Absolute Maximum Ratings

The absolute maximum ratings are stress ratings only. Stresses greater than those listed below can cause permanent damage to the device. Functional operation of the F0448 at absolute maximum ratings is not implied. Exposure to absolute maximum rating conditions may affect device reliability.

Table 2. Absolute Maximum Ratings

Parameter	Symbol	Minimum	Maximum	Units
V _{CC} to GND	V _{CC}	-0.3	+5.5	V
DATA, CSb_A, CSb_B, CLK, VCTRL0_A, VCTRL0_B	V _{LOGIC1}	-0.3	Lower of (V _{CC} , 3.6)	V
STBY_A, STBY_B, VCTRL1_A, VCTRL1_B, VCTRL2_A, VCTRL2_B	V _{LOGIC2}	-0.3	V _{CC} + 0.25	V
RFIN_A, RFIN_B externally applied DC voltage	V _{RFIN}	+1.4	+3.6	V
RFOUT_A, RFOUT_B, externally applied DC voltage	V _{RFOUT}	+1.4	+3.6	V
RF Input Power (RFIN_A or RFIN_B) applied for 24 hours maximum [a]	P _{MAX}		+22	dBm
Continuous Power Dissipation	P _{DISS}		1.5	W
Storage Temperature Range	T _{ST}	-65	150	°C
Lead Temperature (soldering, 10s)			260	°C
ElectroStatic Discharge – HBM (JEDEC/ESDA JS-001-2012)			2000 Class 2	V
ElectroStatic Discharge – CDM (JEDEC 22-C101F)			1000 Class C3	V

[a] Exposure to these maximum RF levels can result in significant V_{CC} current draw due to overdriving the amplifier stage.

Recommended Operating Conditions

Table 3. Recommended Operating Conditions

Parameter	Symbol	Condition	Minimum	Typical	Maximum	Units
Supply Voltage	V _{CC}	All V _{CC} pins	4.75	5.00	5.25	V
Operating Temperature Range	T _{EPAD}	Exposed paddle	-40		+105	°C
Junction Temperature	T _J				+125	°C
RF Frequency Range	f _{RF}		3.4		3.8	GHz
Maximum RF Input Power	P _{IP}	DSA0 = DSA1 = 0dB			0	dBm
RF Source Impedance	Z _{RFI}	Single ended		50		Ω
RF Load Impedance	Z _{RFO}	Single ended		50		Ω

Electrical Characteristics

See F0448 Typical Application Circuit. $V_{CC} = +5V$, $T_C = +25^\circ C$, $f_{RF} = 3.6GHz$ specifications apply when operated as a dual-channel RF DVGA, maximum gain setting, $P_{OUT} = 0dBm$, $Z_{RFI} = Z_{RFO} = 50\Omega$, Evaluation Board (EVKit) traces and connectors are de-embedded, unless otherwise stated.

Table 4. Electrical Characteristics

Parameter	Symbol	Condition	Minimum	Typical	Maximum	Units
Logic Input High	V_{IH}	Applies for all logic levels.	1.07 [a]			V
Logic Input Low	V_{IL}	Applies for all logic levels.			0.63	V
Logic Current (CLK, DATA, CSb_A, CSb_B, VCTRL0_A, VCTRL1_A, VCTRL2_A, VCTRL0_B, VCTRL1_B, VCTRL2_B)	I_{IH}, I_{IL}		-5		5	μA
Logic Current for Standby (STBY_A, STBY_B) [b]	I_{IH-SB}, I_{IL-SB}	5V logic	-5		127	μA
		3.3V logic	-5		87	
		1.8V logic	-5		47	
Supply Current	I_{CC_2}	Both channels on		220	270	mA
	I_{CC_1}	One channel on		110	142	
	I_{CC_STBY}	Standby Mode		7	14	
Startup Time	t_{START}	50% of STBY going LOW to Gain within $\pm 1dB$ with no attenuation.		74		ns
DSA0 Adjustment Range	A_{ADJ0}	6dB step size		6		dB
DSA1 Adjustment Range	A_{ADJ1}	1dB step size		23		dB
DSA2 Adjustment Range	A_{ADJ2}	6dB step size		18		dB
Maximum Attenuation Glitch	$ATTN_G$			2		dB
DSA0 Gain Settling Time	t_{DSA0_1}	50% CTRL to within 0.1dB final value, 0dB state to 6dB state		24	35	ns
	t_{DSA0_2}	50% CTRL to within 0.1dB final value, 6dB state to 0dB state		18	35	
DSA1 Gain Settling Time	t_{DSA1}	50% of CSb to within 0.1dB final value		300		ns
DSA2 Gain Settling Time	t_{DSA2_1}	50% CTRL to within 0.1dB final value, 0dB state to 18dB state		16	35	ns
	t_{DSA2_2}	50% CTRL to within 0.1dB final value, 18dB state to 0dB state		15	35	
DSA0 Phase Settling Time	$t_{DSA0_1_PH}$	50% CTRL to within 1 degree of final value, 0dB state to 6dB state		24	35	ns
	$t_{DSA0_2_PH}$	50% CTRL to within 1 degree of final value, 6dB state to 0dB state		18	35	

Parameter	Symbol	Condition	Minimum	Typical	Maximum	Units
DSA2 Phase Settling Time	$t_{\text{DSA2_1_PH}}$	50% CTRL to within 1 degree of final value, 0dB state to 18dB state		16	35	ns
	$t_{\text{DSA0_1_PH}}$	50% CTRL to within 1 degree of final value, 18dB state to 0dB state		15	35	
Stability K factor	K_{FACT}	Over entire temperature range	1.4			unit
Serial Clock Speed	SPICLK				10	MHz
CSb_A, CSb_B to first serial clock rising edge	t_{LS}	SPI 3 wire bus. 50% of CSb falling edge to 50% of CLK rising edge.	10			ns
Serial Data Hold Time	t_{H}	SPI 3 wire bus. 50% of CLK rising edge to 50% of Data falling edge.	10			ns
Final serial clock rising edge to CSb	t_{LC}	SPI 3 wire bus. 50% of CLK rising edge to 50% of CSb rising edge.	10			ns
RF Input Return Loss	RL_{IN}			15		dB
RF Output Return Loss	RL_{OUT}			20		dB
Gain	G_{MAX}		12	13	13.5	dB
	G_{MIN}	Maximum attenuation	-38.1	-32	-26.4	
	G_{TEMP}	Variation over temperature		± 0.15		
	G_{VAR}	Variation over frequency [c]		± 0.2		
DSA0 Absolute Accuracy	INL_{DSA0}			0.52		dB
DSA1 Step Error	DNL_{DSA1}			0.16		dB
DSA1 Absolute Accuracy	INL_{DSA1}			0.55		dB
DSA2 Step Error	DNL_{DSA2}			0.32		dB
DSA2 Absolute Accuracy	INL_{DSA2}			0.43		dB
Relative Phase DSA0	$\Phi_{\text{PH_DSA0}}$			6.6		deg
Phase Deviation DSA1	$\Phi_{\text{PH_DSA1}}$	Between adjacent states		3		deg
Relative Phase DSA2	$\Phi_{\text{PH_DSA2}}$	Any State		6.6		deg
Noise Figure	NF			5.9		dB
	NF_{HOT}	$T_{\text{EPAD}} = +105^{\circ}\text{C}$		6.6		
	NF_{22}	DSA1 22dB attenuation		27.7		

Parameter	Symbol	Condition	Minimum	Typical	Maximum	Units
Output Third Order Intercept Point	OIP ₃₁	1MHz tone separation	34	37		dBm
	OIP ₃₂	1MHz tone separation P _{OUT} = -10dBm/tone	33	35		
	OIP _{36dB}	1MHz tone separation DSA0 full attenuation		37		
	OIP ₃₃	1MHz tone separation Worst case over temp range	33	36		
	OIP _{318dB}	P _{OUT} = -18dBm/tone 1MHz tone separation DSA2 full 18dB attenuation		21		
Input 1dB Compression ^[d]	IP1dB	Full attenuation		24		dBm
Output 1dB Compression	OP1dB			18		dBm
Reverse Isolation	REVI _{SO}		19	22		dB
Channel Isolation ^[e]	CHI _{SO}		35	39		dB
		Over voltage and temperature		39		

- [a] Specifications in the minimum/maximum columns that are shown in ***bold italics*** are guaranteed by test. Specifications in these columns that are not shown in bold italics are guaranteed by design characterization.
- [b] During standby mode, SPI is to be left ON and previous state is maintained when device is powered up.
- [c] Including frequency and ripple variations valid within each individual 3GPP band.
- [d] Input 1dB compression point is a linearity figure of merit. For maximum RF input power, see Absolute Maximum Ratings.
- [e] Signal applied to RFIN_A (RFIN_B), measure desired signal at RFOUT_A (RFOUT_B) and compare to signal level at RFOUT_B (RFOUT_A). Maximum gain setting.

Thermal Characteristics

Table 5. Package Thermal Characteristics

Parameter	Symbol	Value	Units
Junction to Ambient Thermal Resistance.	θ_{JA}	37.1	$^{\circ}C/W$
Junction to Case Thermal Resistance. (Case is defined as the exposed paddle)	θ_{JC-BOT}	9.1	$^{\circ}C/W$
Moisture Sensitivity Rating (Per J-STD-020)		MSL 1	

Typical Operating Conditions (TOC)

Unless otherwise noted, for the TOC graphs on the following pages, the following conditions apply:

- $V_{CC} = 5.0V$
- $Z_L = Z_S = 50\Omega$ Single ended
- $f_{RF} = 3.6GHz$
- $T_{EPAD} = +25^{\circ}C$
- Gain setting = Maximum gain
- STBY = LOW
- $P_{OUT} = 0dBm/ton$ e
- 1MHz Tone Spacing
- ATTN setting = 0dB (Maximum gain; DSA0 = DSA1 = DSA2 = 0dB)
- All temperatures are referenced to the exposed paddle
- Evaluation Kit traces and connector losses are de-embedded

Typical Performance Characteristics

Figure 2. Maximum Gain vs. Frequency

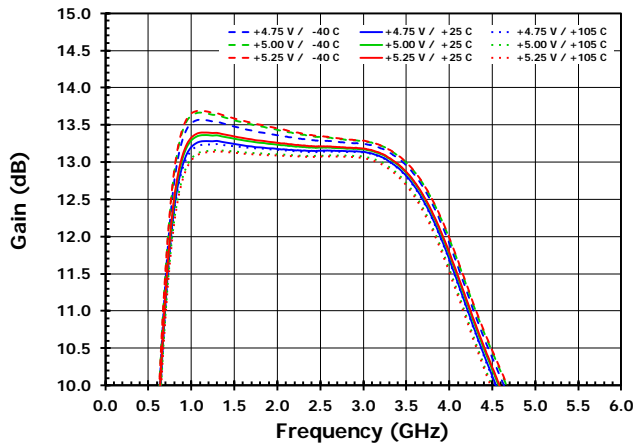


Figure 3. Gain vs. Frequency for DSA0 Settings

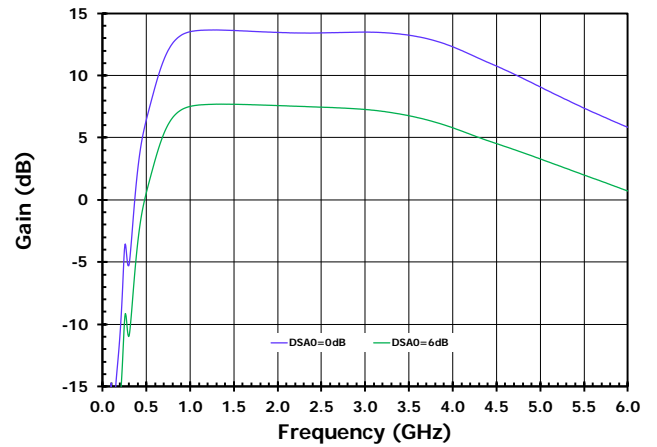


Figure 4. Gain vs. Frequency for DSA1 Settings

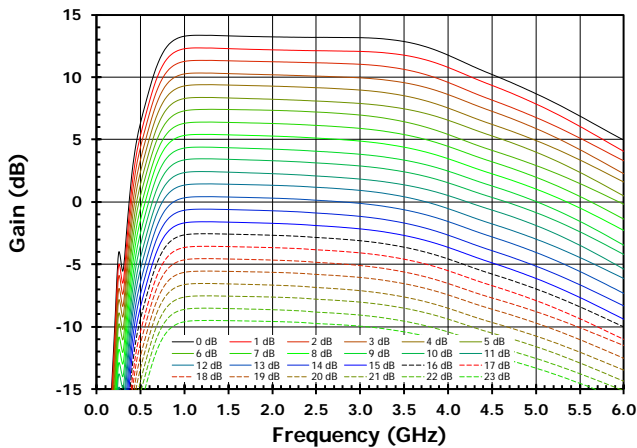


Figure 5. Gain vs. Frequency for DSA2 Settings

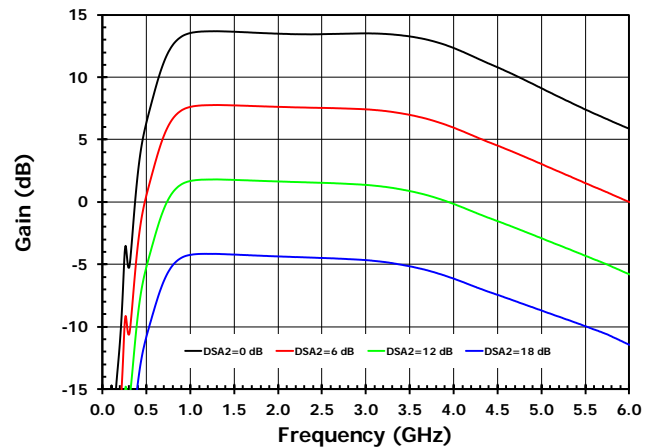


Figure 6. Stability vs. Frequency as a Function of Voltage and Temperature

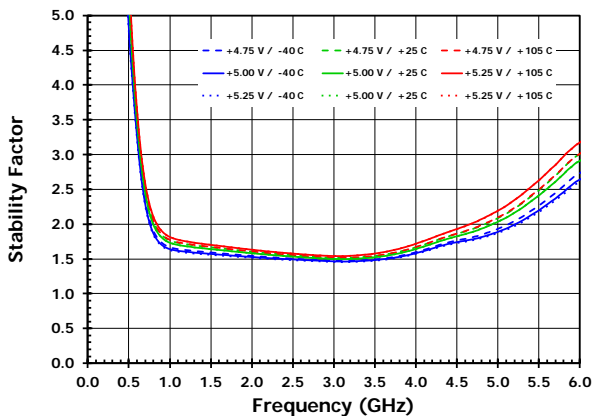


Figure 7. Input Return Loss for DSA0 Settings

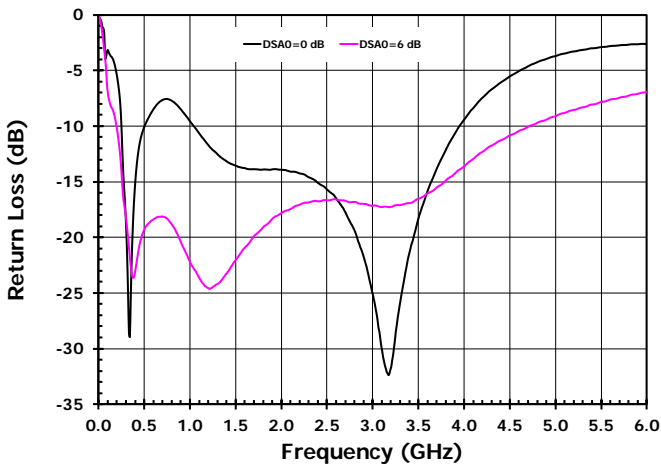


Figure 8. Output Return Loss for DSA0 Settings

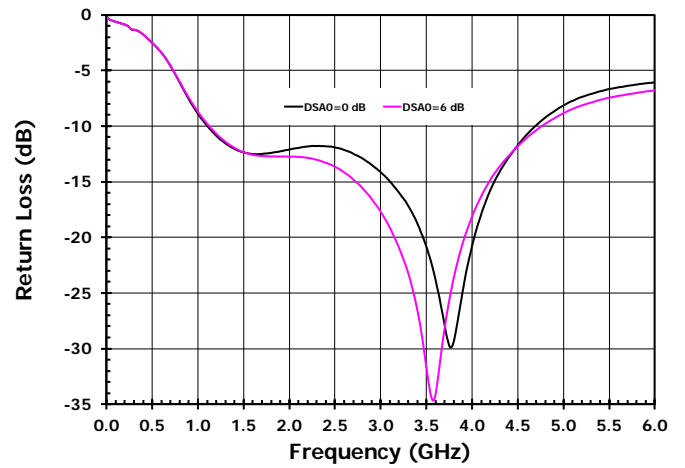


Figure 9. Input Return Loss for DSA1 Settings

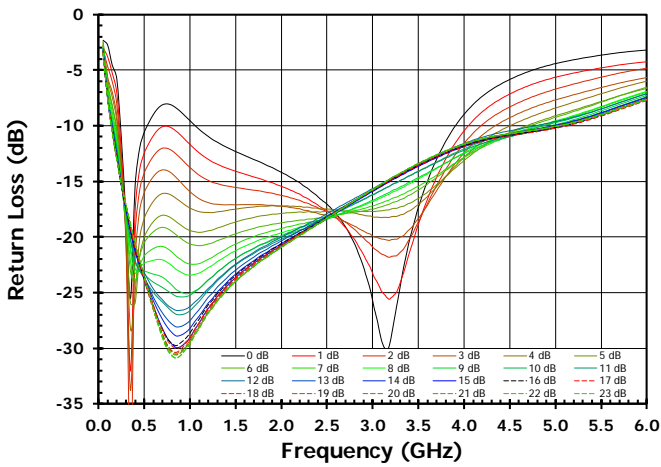


Figure 10. Output Return Loss for DSA1 Settings

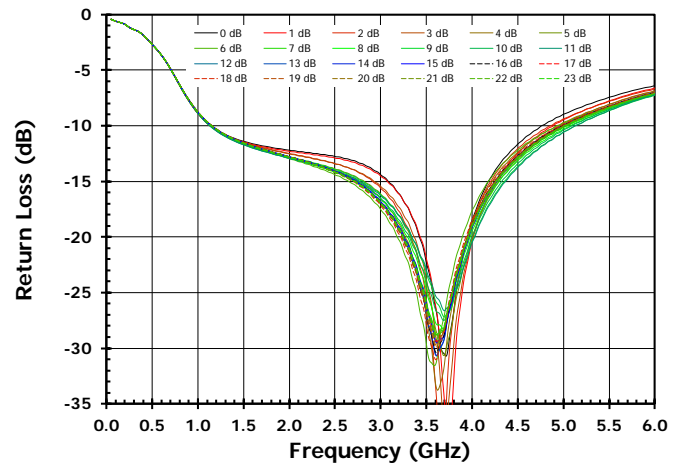


Figure 11. Input Return Loss for DSA2 Settings

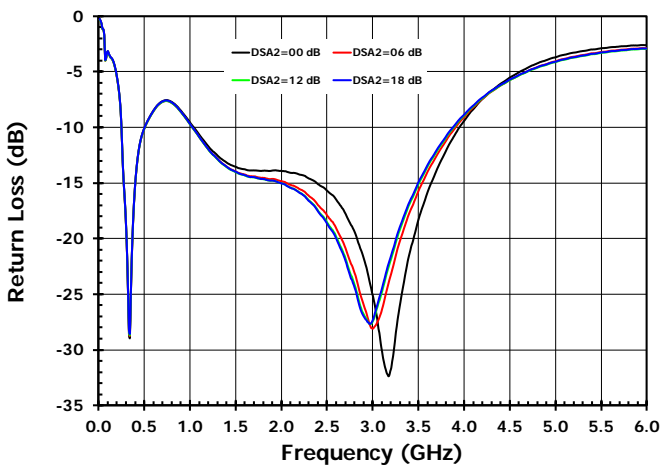


Figure 12. Output Return Loss for DSA2 Settings

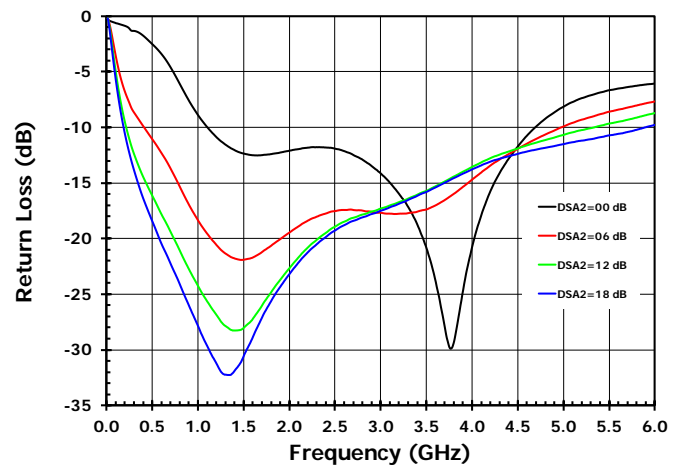


Figure 13. Reverse Isolation for DSA0 Settings

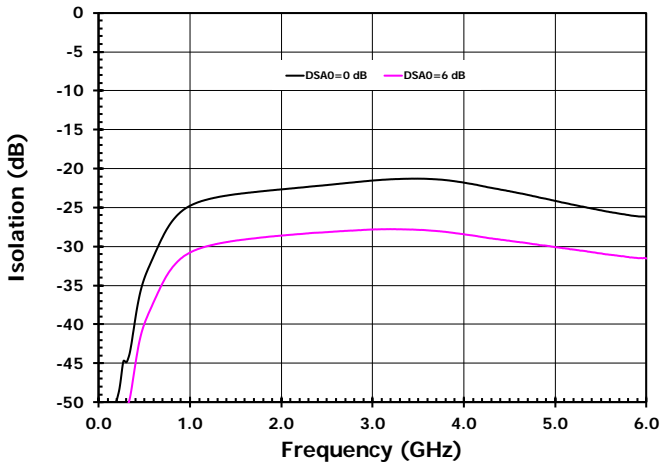


Figure 14. Phase Deviation Between Adjacent States vs. DSA0 Setting

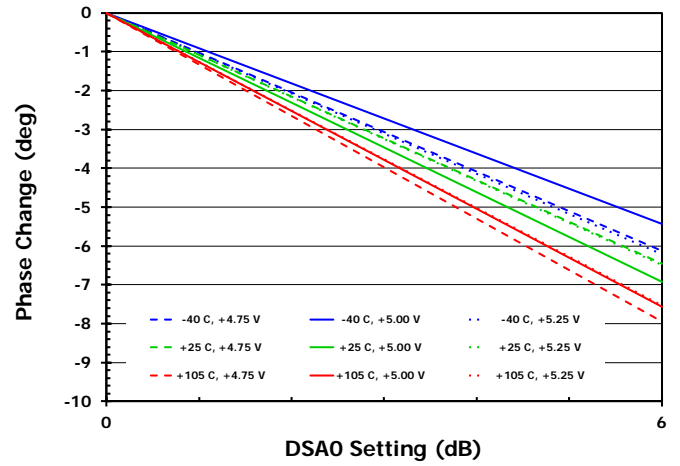


Figure 15. Reverse Isolation for DSA1 Settings

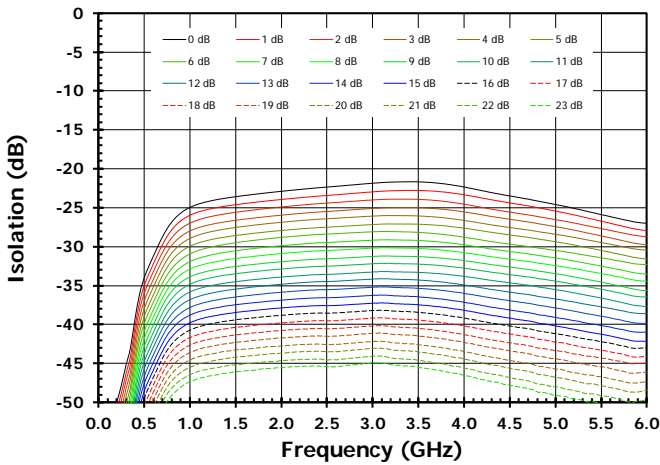


Figure 16. Phase Deviation Between Adjacent States vs. DSA1 Setting

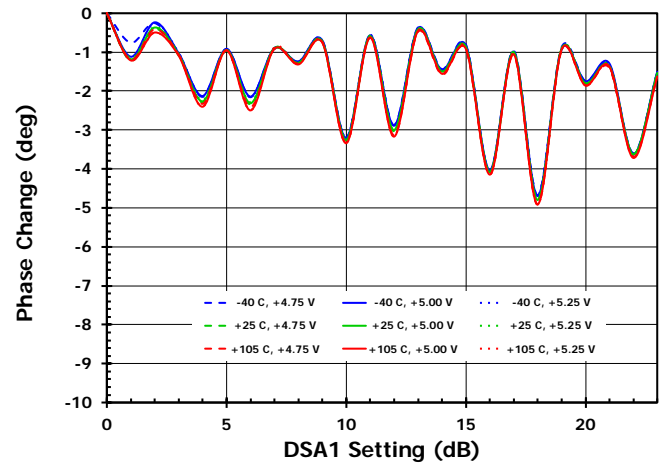


Figure 17. Reverse Isolation for DSA2 Settings

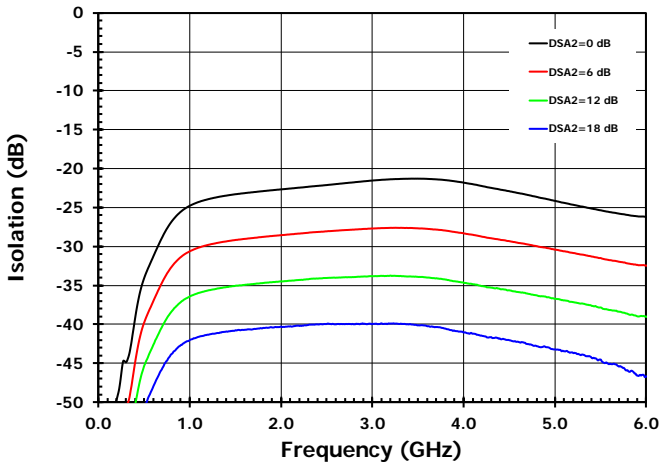


Figure 18. Phase Deviation Between Adjacent States vs. DSA2 Setting

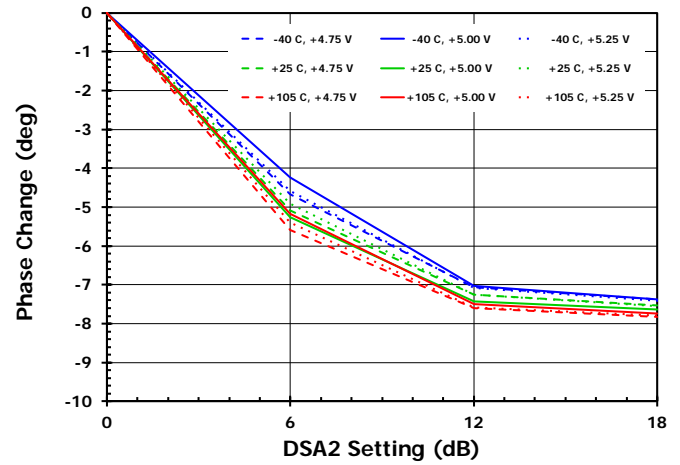


Figure 19. DSA0 Absolute Attenuation Error (INL)

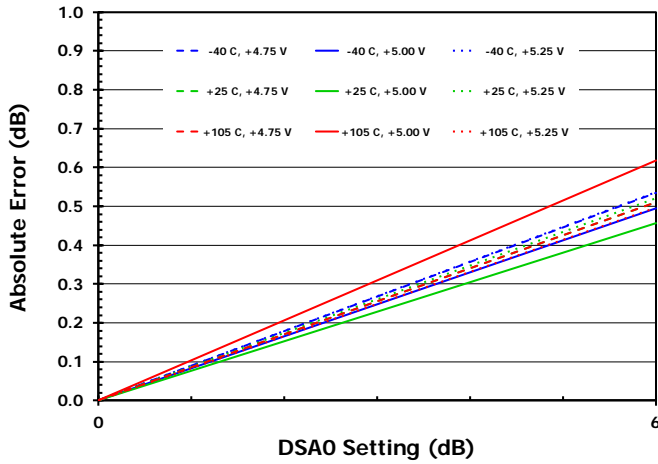


Figure 20. DSA0 Attenuator Step Error (DNL)

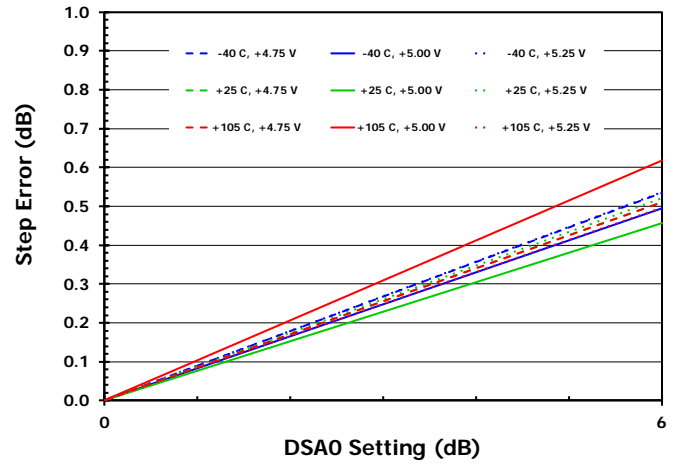


Figure 21. DSA1 Absolute Attenuation Error (INL)

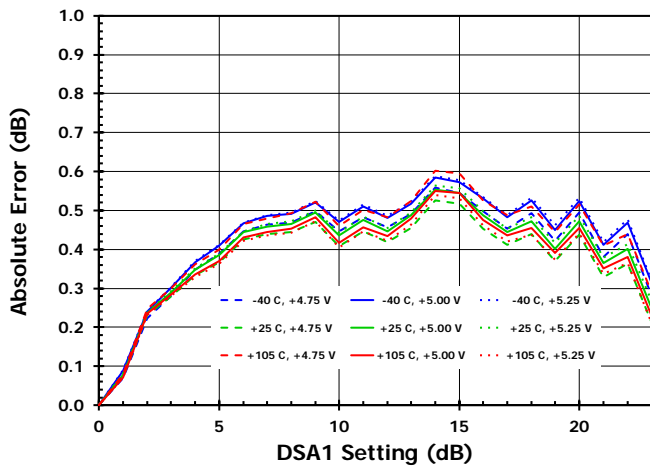


Figure 22. DSA1 Attenuator Step Error (DNL)

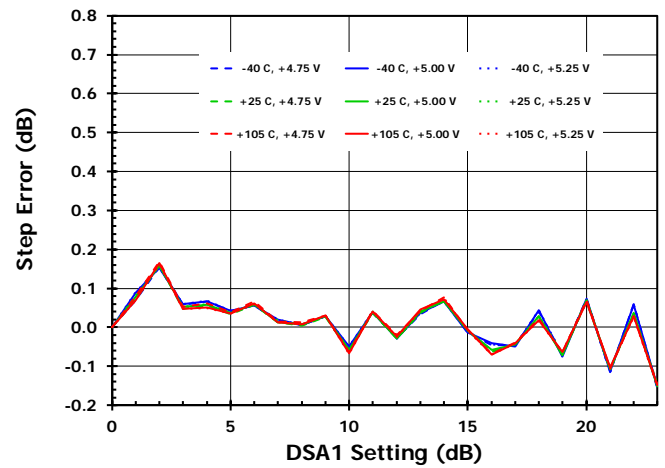


Figure 23. DSA2 Absolute Attenuation Error (INL)

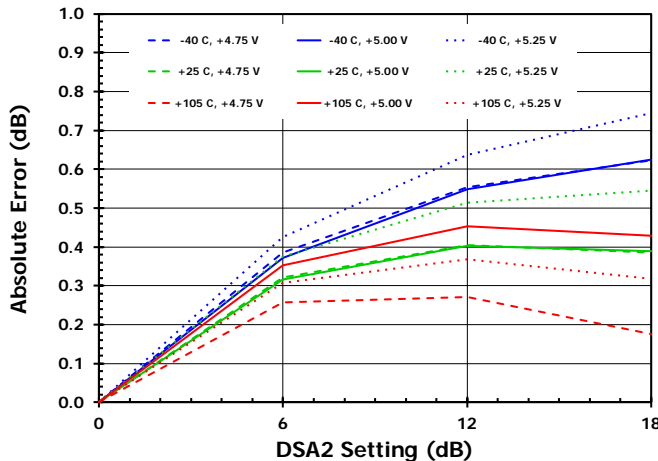


Figure 24. DSA2 Attenuator Step Error (DNL)

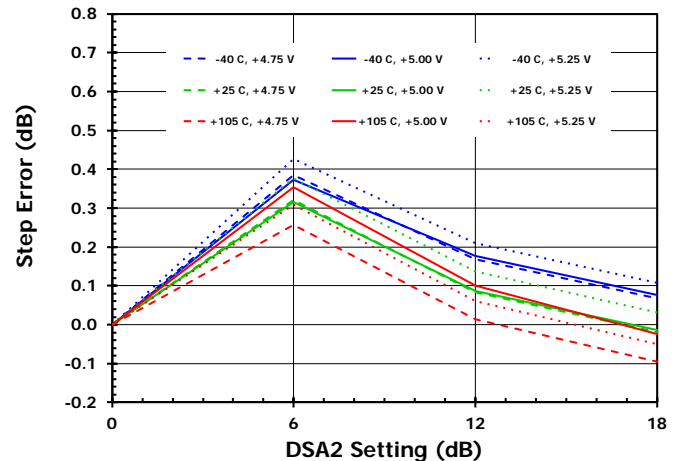


Figure 25. OIP3 vs. Frequency with $P_{OUT} = 0\text{dBm/Tone}$ and Max Gain

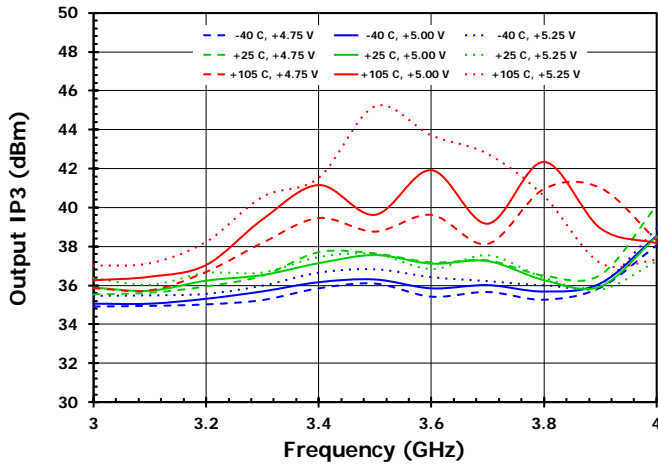


Figure 26. OIP3 vs. Frequency with $P_{OUT} = -10\text{dBm/Tone}$ and Max Gain

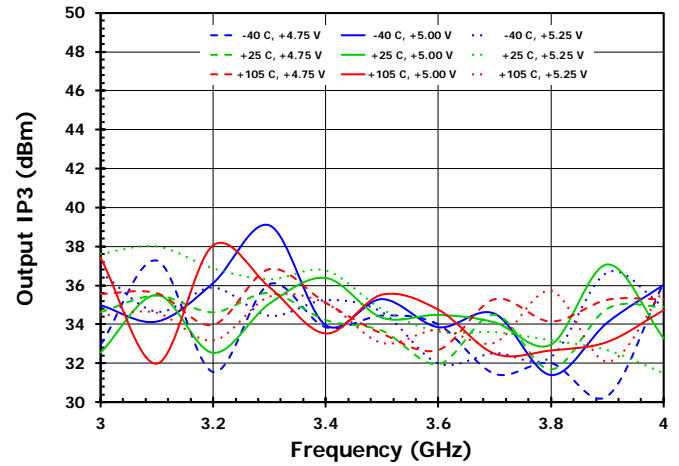


Figure 27. OIP3 vs. Frequency with $P_{OUT} = -18\text{dBm/Tone}$ and DSA2 = 18dB

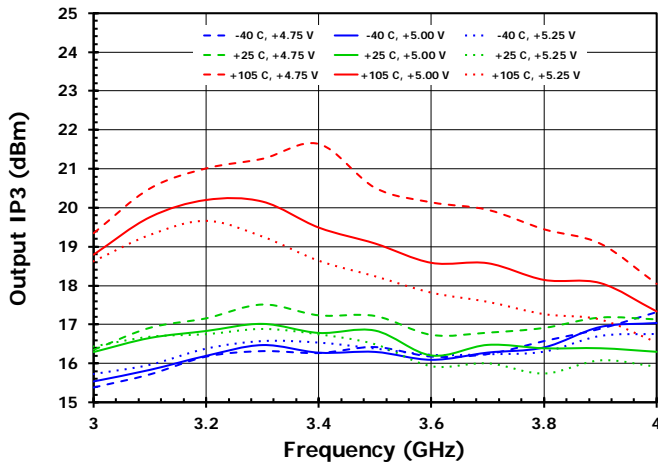


Figure 28. OIP3 vs. Frequency as a Function of Tone Spacing with $P_{OUT} = 0\text{dBm/Tone}$

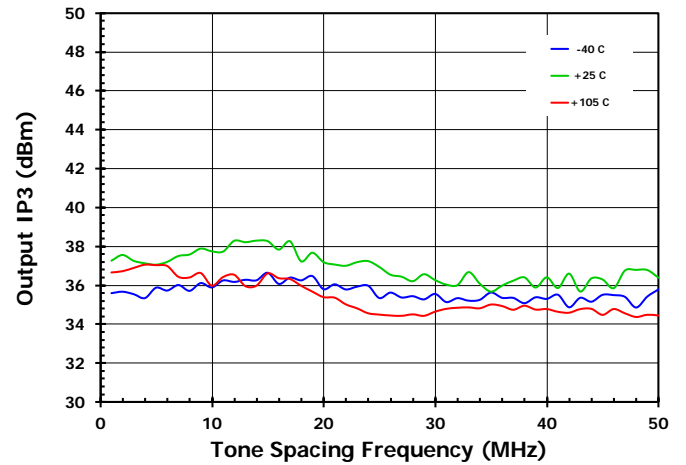


Figure 29. OIP3 vs. Frequency with $P_{OUT} = 0\text{dBm/Tone}$ and DSA0 = 6dB

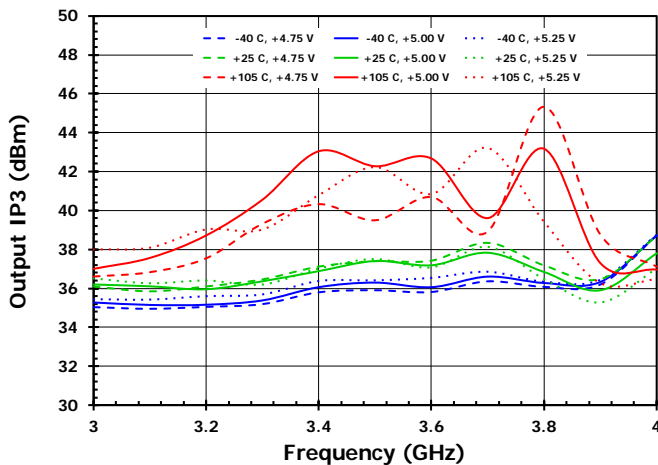


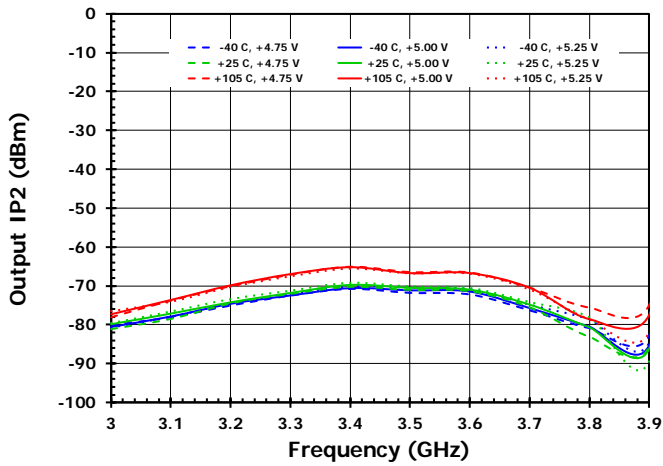
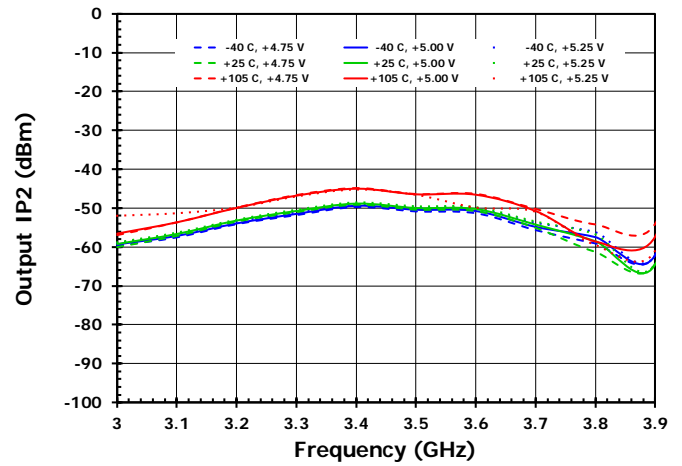
Figure 30. Wideband OIP2 vs. Frequency with $P_{OUT} = -10\text{dBm/Tone}$

 Figure 31. Wideband OIP2 vs. Frequency with $P_{OUT} = 0\text{dBm/Tone}$


Figure 32. NF vs. Frequency as a Function of Temperature at Max Gain

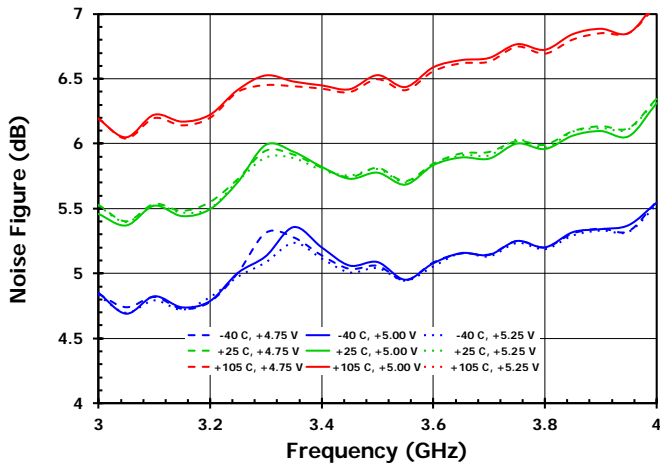


Figure 33. NF vs. Frequency as a Function of Temperature with DSA1 = 22dB

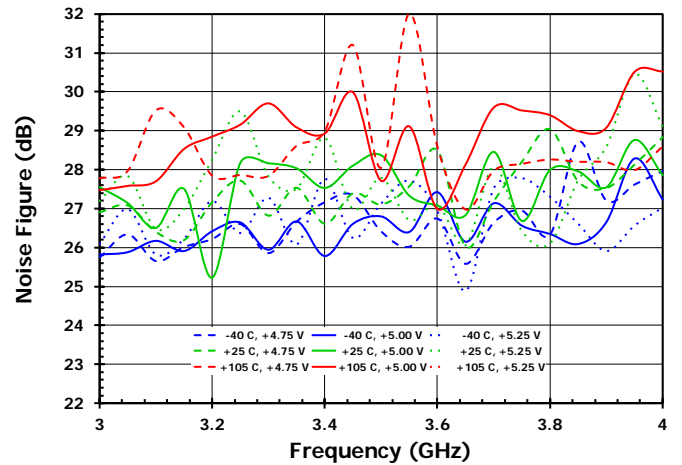
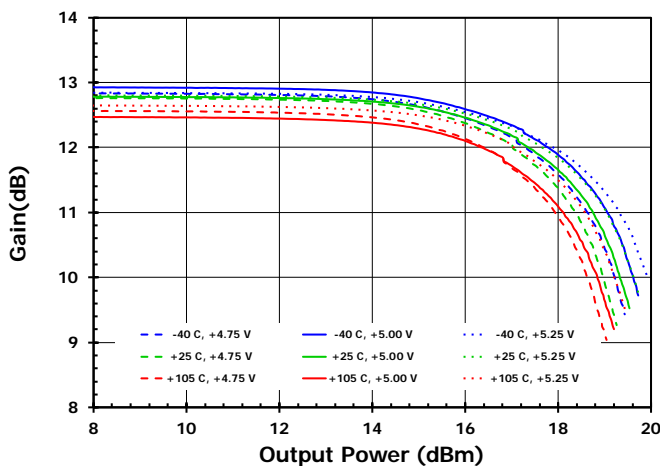
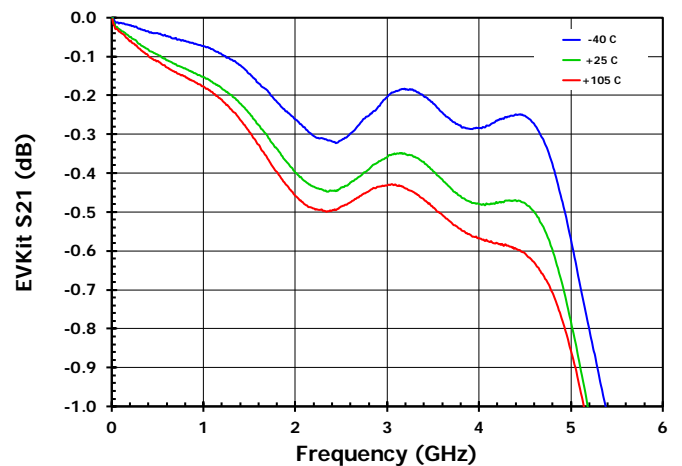

 Figure 34. Gain Compression at $f_{RF} = 3.6\text{GHz}$


Figure 35. EVKit Connector and Trace Losses



Programming

The F0448 is programmed in both the serial and parallel. The 23dB attenuator (DSA1) is programmed using a three-wire serial control line. You choose which channel is programmed by using either or both CSb lines. Parallel pins are used for the one-bit 6dB attenuator ((DSA0_A, DSA0_B) and two-bit 18dB (6dB step) attenuator (DSA2_A, DSA2_B). The standby pins are also controlled by the parallel pin. All logic is both 1.8V and 3.3V compatible.

Serial Control – DSA1

The serial interface uses an 8-bit word with only 5 bits used. The serial word is shifted in LSB (D0) first.

Figure 36. Serial Register Data Flow Diagram (LSB Clock in First)

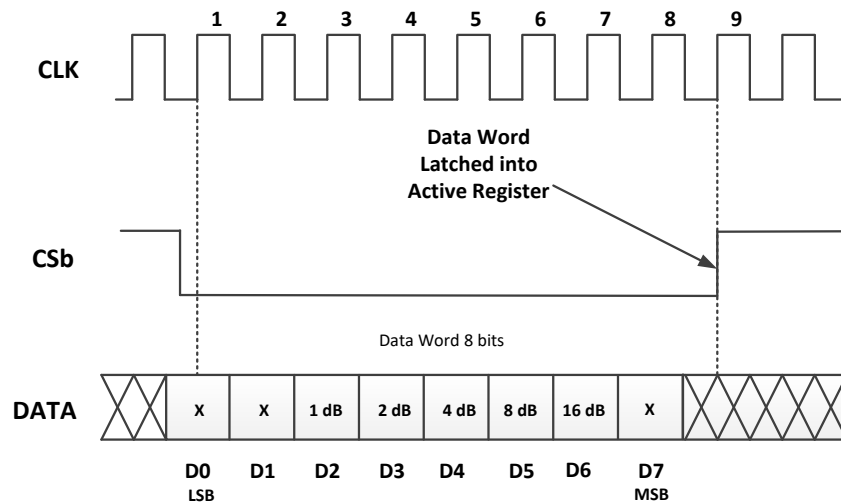


Figure 37. DSA1 Default Condition

When the device is first powered up, DSA1 will default to the **Maximum Attenuation** setting as shown.

Default Register Setting

x	x	1	1	1	1	1	x
D0 LSB	D1	D2	D3	D4	D5	D6	D7 MSB

The F0448 includes a CLK inhibit feature designed to minimize sensitivity to CLK bus noise when the device is not being programmed. When CSb is high ($> V_{IH}$), the CLK input is disabled and serial data (DATA) is not clocked into the shift register. It is recommended that CSb be pulled high ($> V_{IH}$) when the device is not being programmed.

Table 6. DSA1 Attenuation Word Truth Table (LSB = First In)

D7 (MSB)	Attenuation word								Attenuation Setting (dB)
	D6	D5	D4	D3	D2	D1	D0 (LSB)		
x	LOW	LOW	LOW	LOW	LOW	x	x	0	
x	LOW	LOW	LOW	LOW	HIGH	x	x	1	
x	LOW	LOW	LOW	HIGH	LOW	x	x	2	
x	LOW	LOW	HIGH	LOW	LOW	x	x	4	
x	LOW	HIGH	LOW	LOW	LOW	x	x	8	
x	HIGH	LOW	LOW	LOW	LOW	x	x	16	
x	HIGH	LOW	HIGH	HIGH	LOW	x	x	22	
x	HIGH	LOW	HIGH	HIGH	HIGH	x	x	23 (max)	
x	HIGH	HIGH	LOW	LOW	LOW	x	x	23 (max)	
x	HIGH	HIGH	LOW	LOW	HIGH	x	x	23 (max)	
x	HIGH	HIGH	LOW	HIGH	LOW	x	x	23 (max)	
x	HIGH	HIGH	LOW	HIGH	HIGH	x	x	23 (max)	
x	HIGH	HIGH	HIGH	LOW	LOW	x	x	23 (max)	
x	HIGH	HIGH	HIGH	LOW	HIGH	x	x	23 (max)	
x	HIGH	HIGH	HIGH	HIGH	LOW	x	x	23 (max)	
x	HIGH	HIGH	HIGH	HIGH	HIGH	x	x	23 (max)	

Figure 38. Serial Timing Diagram

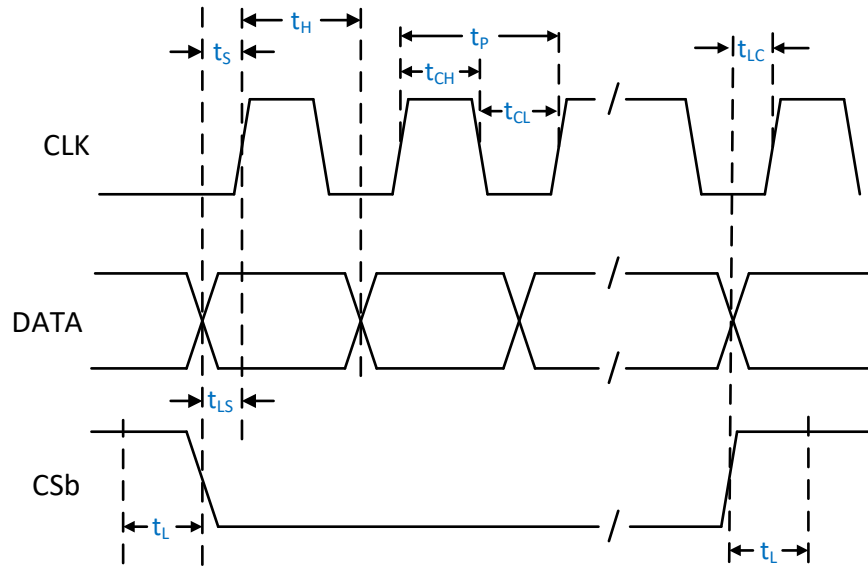


Table 7. SPI Timing Diagram Values for Figure 38

Parameter	Symbol	Test Condition	Minimum	Typical	Maximum	Units
CLK Frequency	f_c				10	MHz
CLK High Duration Time	t_{CH}		50			ns
CLK Low Duration Time	t_{CL}		50			ns
DATA to CLK Setup Time	t_s		10			ns
CLK Period ^[a]	t_p		100			ns
CLK to DATA Hold Time	t_H		10			ns
CSb to CLK Setup Time	t_{LS}		10			ns
CSb Trigger Pulse Width	t_L		10			ns
CSb Trigger to CLK Setup Time ^[b]	t_{LC}		10			ns

[a] $(t_{CH} + t_{CL}) \geq 1/f_c$

[b] Once all desired DATA is clocked in, t_{LC} represents the time a CSb high needs to occur before any subsequent CLK signals.

Parallel Control Mode – DSA0, DSA2, STBY

Externally set the parallel control pins either logic LOW or HIGH.

Table 8. DSA0 Truth Table

VCTRL0_A (VCTRL0_B)	ATTENUATION SETTING (dB) DSA0_A or DSA0_B
LOW	0 (Reference IL)
HIGH	6

Table 9. DSA2 Truth Table

VCTRL1_A (VCTRL1_B)	VCTRL2_A (VCTRL2_B)	ATTENUATION SETTING (dB) DSA2_A or DSA2_B
LOW	LOW	0 (Reference IL)
HIGH	LOW	6
LOW	HIGH	12
HIGH	HIGH	18

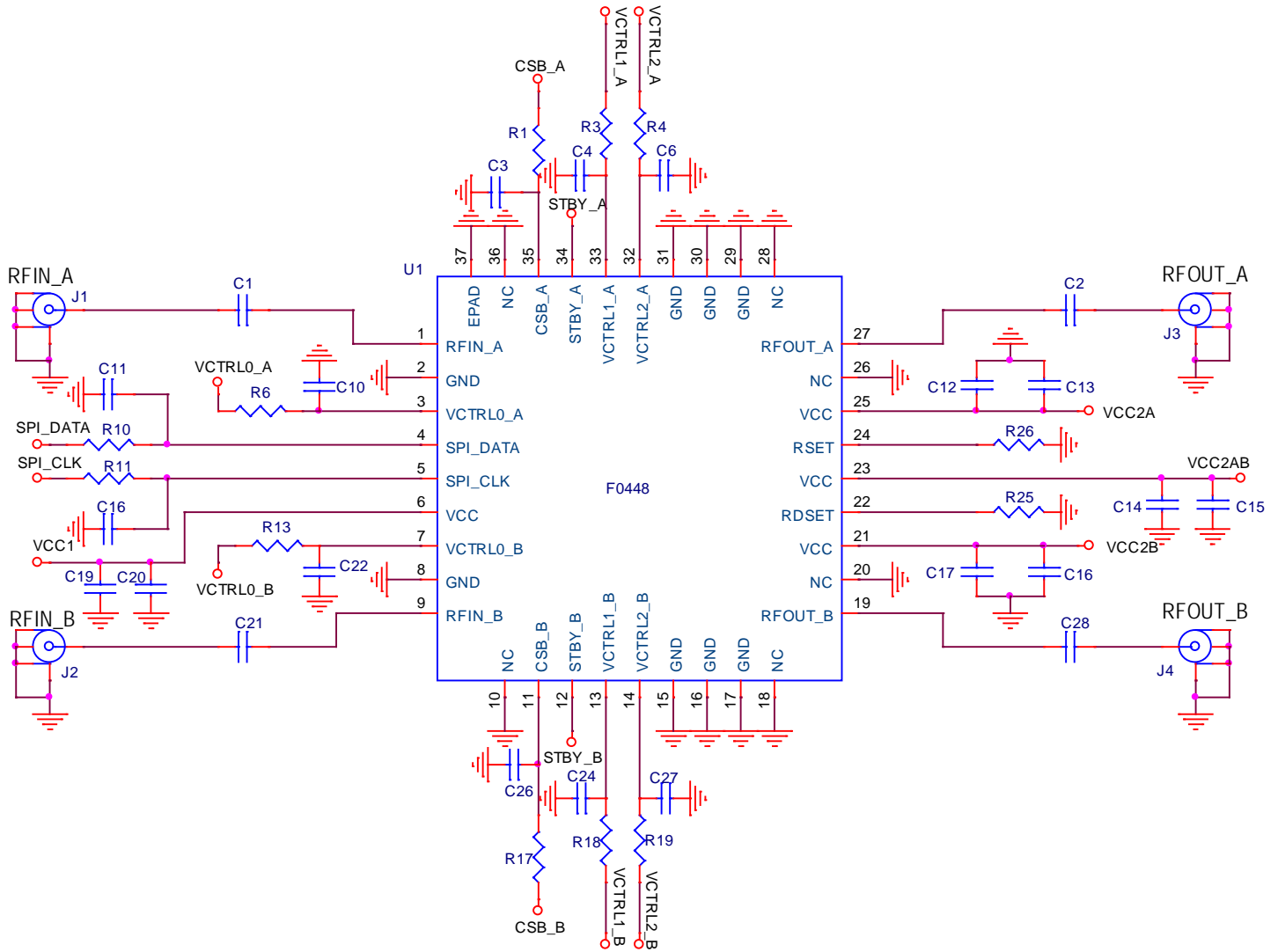
Table 10. STANDBY Truth Table

Control Pins	Logic Level	Function
STBY_A, STBY_B	LOW (or open)	Channel Powered On
	HIGH	Channel Powered OFF

Typical Application Circuit

Figure 39 is a typical circuit that can be used in a design for the F0448.

Figure 39. Electrical Schematic



Evaluation Kit Picture

Figure 40. Top View

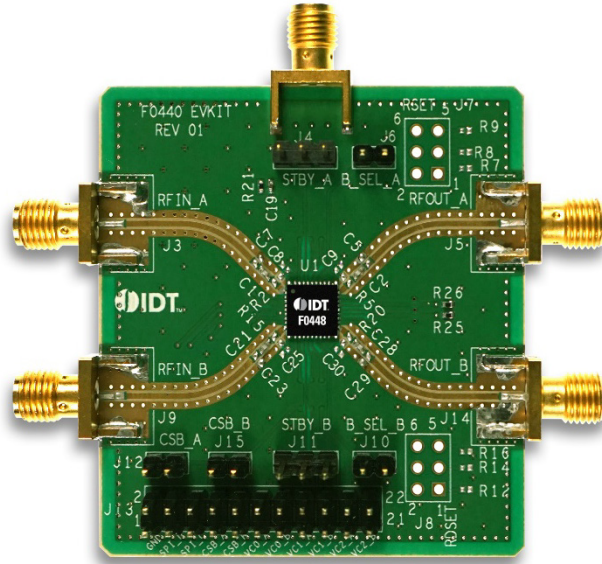
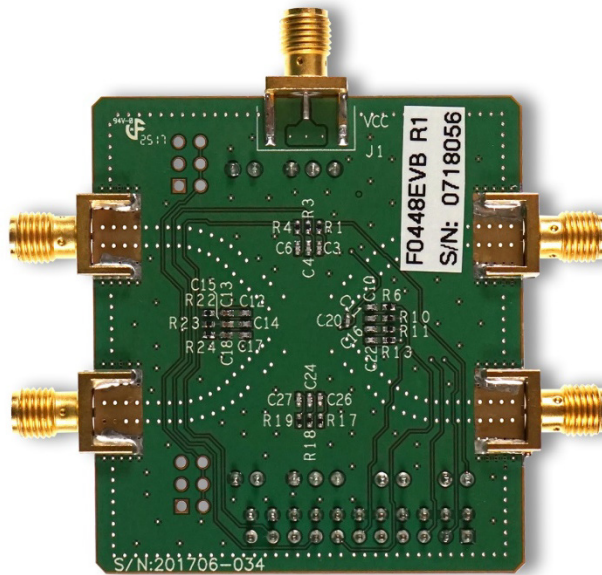


Figure 41. Bottom View



Evaluation Kit / Applications Circuit

Figure 42 is the evaluation board schematic.

Figure 42. Electrical Schematic

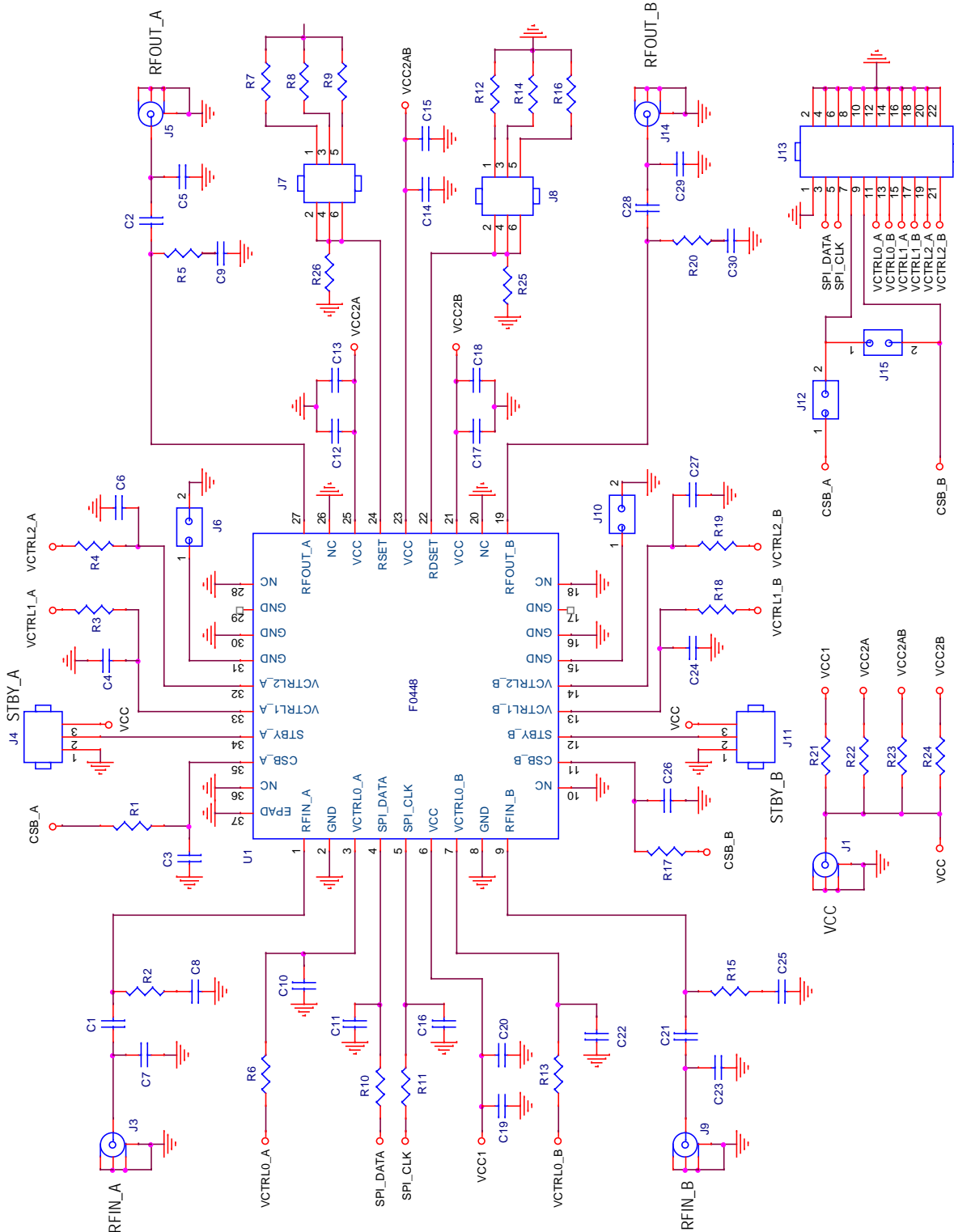


Table 11. Bill of Material (BOM)

Part Reference	QTY	Description	Manufacturer Part #	Manufacturer
C1, C2, C21, C28	4	47pF \pm 5%, 50V, C0G Ceramic Capacitor (0402)	GRM1555C1H470J	Murata
C3, C4, C6, C10, C11, C16, C22, C24, C26, C27	10	2pF \pm 0.1pF, 50V, C0G Ceramic Capacitor (0402)	GRM1555C1H2R0B	Murata
C12, C14, C17, C20	4	1000pF \pm 5%, 50V, C0G Ceramic Capacitor (0402)	GRM1555C1H102J	Murata
C13, C15, C18, C19	4	0.1 μ F \pm 10%, 16V, X7R Ceramic Capacitor (0402)	GRM155R71C104K	Murata
R1, R3, R4, R6, R10, R11, R13, R17, R18, R19	10	5.11k Ω \pm 1%, 1/10W, Resistor (0402)	ERJ-2RKF5111X	Panasonic
R21, R22, R23, R24	4	0 Ω Resistor (0402)	ERJ-2GE0R00X	Panasonic
R25, R26	2	4.42k Ω \pm 1%, 1/10W, Resistor (0402)	ERJ-3EKF4421V	Panasonic
J1, J3, J5, J9, J14	5	Edge Launch SMA (0.375 inch pitch ground tabs)	142-0701-851	Emerson Johnson
J4, J11	2	CONN HEADER VERT SGL 3 X 1 POS GOLD	961103-6404-AR	3M
J6, J10, J12, J15	4	CONN HEADER VERT SGL 2 X 1 POS	961102-6404-AR	3M
J13	1	CONN HEADER VERT SGL 11 X 2 POS GOLD	67997-122HLF	FCI
U1	1	Dual DVGA	F0448NBGK	IDT
	1	Printed Circuit Board	F0440 EVKIT REV 01	IDT
C5, C7, C8, C9, C23, C25, C29, C30, R2, R5, R15, R20, R7, R8, R9, R12, R14, R16, J7, J8		DNP		

Evaluation Kit Operation

Power Supply Setup

Set up a power supply in the voltage range of 4.75V to 5.25V with the power supply output disabled. The voltage is applied via the SMA connector, J1, show in Figure 43 and Figure 44.

Figure 43. Power Supply Connections – Top View

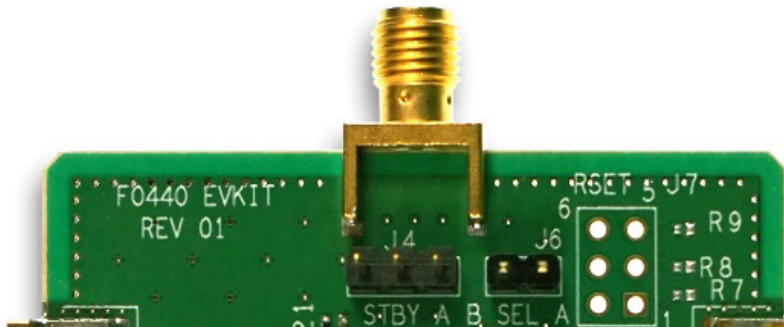
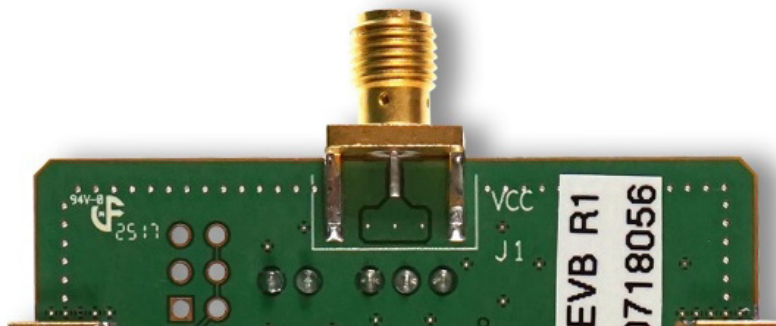


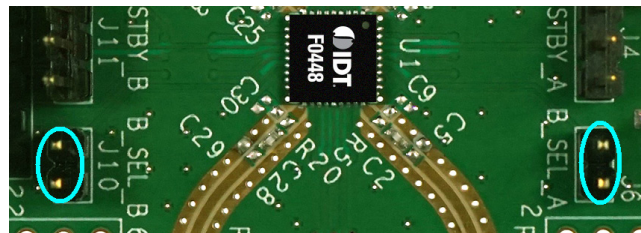
Figure 44. Power Supply Connections – Bottom View



GND Jumpers

Headers J6 and J10 must be jumped (grounded) for optimum RF performance. Figure 45 shows the header locations.

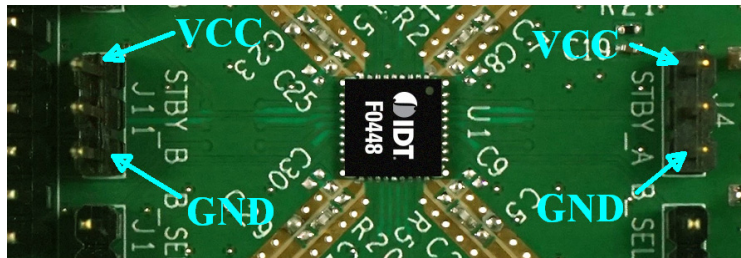
Figure 45. Two Ground Jumper Connections



Standby (STBY) Pin

The Evaluation Board can control the F0448 for standby operation. The standby pin is the center pin of the J4 and J11 header as shown in Figure 46. VCC (logic HIGH) and ground (logic LOW) pins are available to make a connection with a jumper.

Figure 46. Two Standby Pin Connections



To place channel A in the normal operation mode (on), use one of these options:

- Make no connections on J4.
- Apply a logic LOW signal to STBY (pin 2 of J4 or the middle pin).
- Make a connection between pin 1 (GND) and pin 2 (STBY, the middle pin) of J4.

To place channel A in the standby mode (off), use one of these options:

- Apply a logic HIGH signal to the STBY (pin 2 of J4 or the middle pin).
- Make a connection between pin 3 (VCC) and pin 2 (STBY, the middle pin) of J4.

To place channel B in the normal operation mode (on), use one of these options:

- Make no connections on J11.
- Apply a logic LOW signal to STBY (pin 2 of J11 or the middle pin).
- Make a connection between pin 1 (GND) and pin 2 (STBY, the middle pin) of J11.

To place channel B in the standby mode (off), use one of these options:

- Apply a logic HIGH signal to the STBY (pin 2 of J11 or the middle pin).
- Make a connection between pin 3 (VCC) and pin 2 (STBY, the middle pin) of J11.

Serial Control

Both channels have a digital controlled attenuator, DSA1_A and DSA1_B, which share the serial control word. The serial control pins are on header J13 and are shown in Figure 47. Table 12 lists the pin functions on header J13.

Figure 47. Two Jumpers for Serial Programming Connections

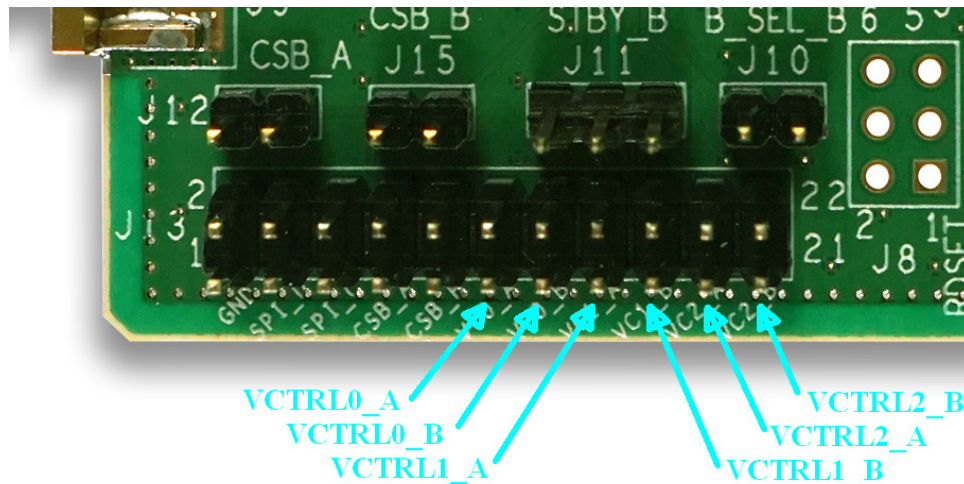


Table 12. J13 Header Pins

Pin	Label	Pin	Label
1	GND	2	GND
3	DATA	4	GND
5	CLK	6	GND
7	CSb_A	8	GND
9	CSb_B	10	GND
11	VCTRL0_A	12	GND
13	VCTRL0_B	14	GND
15	VCTRL1_A	16	GND
17	VCTRL1_B	18	GND
19	VCTRL2_A	20	GND
21	VCTRL2_B	22	GND

Each channel has its own latch pins, CSB_A and CSB_B (pin 7 of J13 and pin 9 of J13) so each channel attenuator can be independently controlled. If you only have one latch signal, the ability to control each channel attenuator achieved using headers J12 and J15. The latch signal must be applied to CSB_A (pin 7 of J13). Table 13 lists the operation for the connections on these headers.

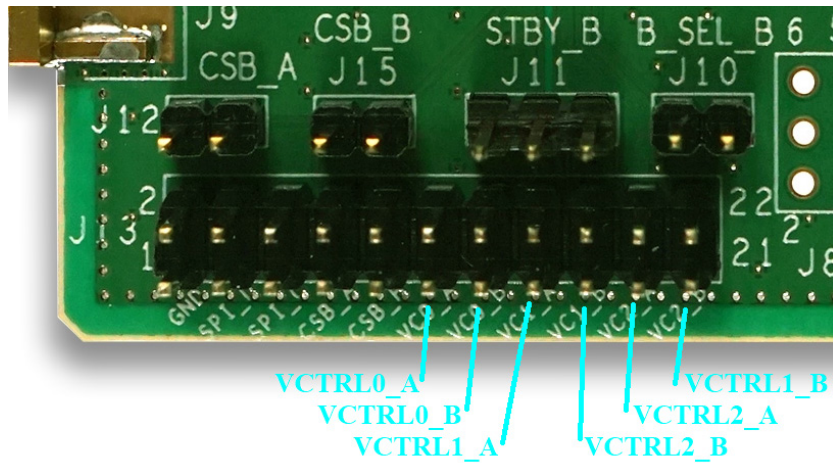
Table 13. Attenuator Control Using One Latch Signal

J12	CSb_B	Function
OPEN	OPEN	No control of attenuators
OPEN	CLOSED	DSA1_B attenuator is controlled
CLOSED	OPEN	DSA1_A attenuator is controlled
CLOSED	CLOSED	DSA1_A attenuator is controlled DSA1_B attenuator is controlled

Parallel Control Pins

Both channels have two other attenuators, DSA0 and DSA1, which are parallel controlled. These parallel pins are located on header J13 shown in Figure 48. Table 12 lists the pin functions on header J13.

Figure 48. Parallel Pin Connections



See Table 8 and Table 9 for the attenuation control.

Power-On Procedure

Set up the voltage supplies and Evaluation Board as described in “Power Supply Setup” with the “Standby Pin” set for logic LOW, then enable the power supply.

Power-Off Procedure

Disable the power supply.

Application Information

The F0448 is optimized for use in high-performance RF applications from 3.4GHz to 3.6GHz.

Power Supplies

Bypass supply pins with external capacitors to minimize noise and fast transients. Supply noise can degrade noise figure and fast transients can trigger ESD clamps and cause them to fail. Supply voltage change or transients should have a slew rate smaller than $1V/20\mu S$. In addition, all control pins should remain at 0V ($\pm 0.3V$) while the supply voltage ramps or while it returns to zero.

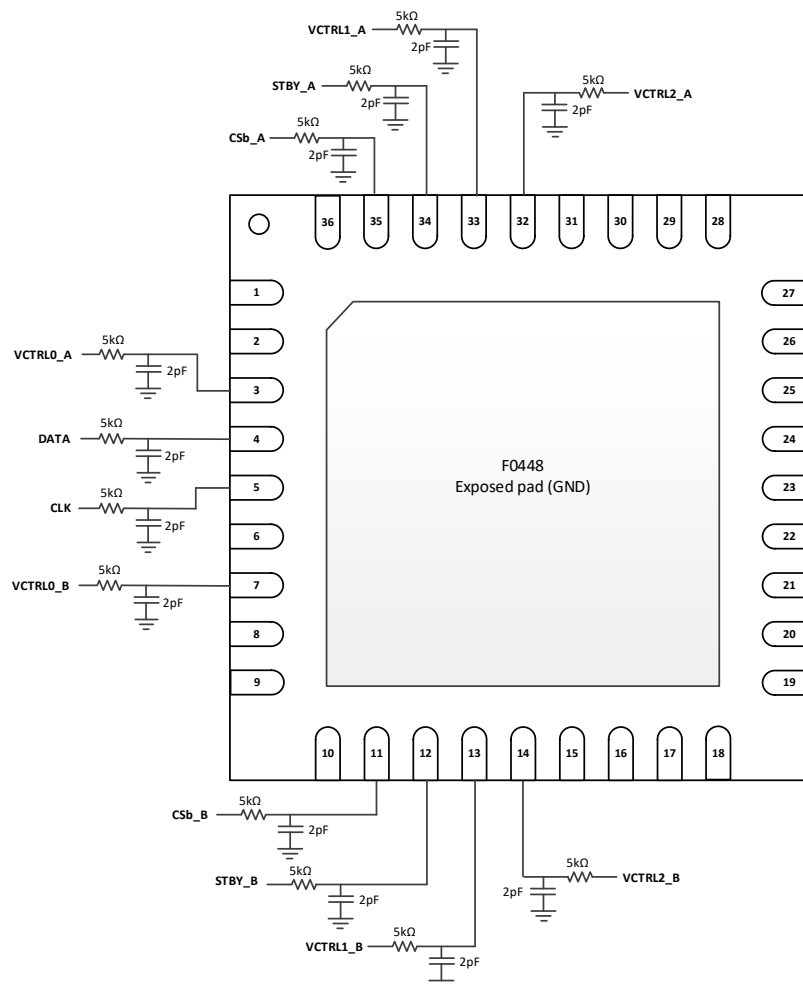
RSET and RDSET

The F0448 is optimized for gain and intermodulation products by adjusting the bias resistors RSET and RDSET. For the optimized setting, RSET (R26) and RDSET (R25) are 4.42k Ω .

Control Pin Interface

If control signal integrity is a concern and clean signals cannot be guaranteed due to overshoot, undershoot, ringing, etc., the following circuit at the input of each control pin is recommended. This applies to control pins 3-7, 11-14, and 32-35 as shown below. Note the recommended resistor and capacitor values do not necessarily match the EVKit BOM for the case of poor control signal integrity.

Figure 49. Control Pin Interface

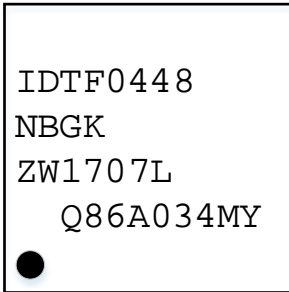


Package Outline Drawings

The package outline drawings are appended at the end of this document and are accessible from the link below. The package information is the most current data available.

<https://www.idt.com/document/psc/nbnbg36-package-outline-60-x-60-mm-body-epad-410-mm-sq-050-mm-pitch-qfn>

Marking Diagram



- Line 1 and 2 are the part number.
- Line 3 "ZW" is for die version.
- Line 3 "yyww = 1707" has two digits for the year and week that the part was assembled.
- Line 3 "L" denotes Assembly Site.
- Line 4 "Q86A034MY" is the Assembly Lot number.

Ordering Information

Orderable Part Number	Package	MSL Rating	Shipping Packaging	Temperature
F0448NBGK	6 × 6 × 0.75 mm 36-QFN	1	Tray	-40°C to +105°C
F0448NBGK8	6 × 6 × 0.75 mm 36-QFN	1	Tape and Reel	-40°C to +105°C
F0448EVB	Evaluation Board			
F0448EVS	Evaluation Solution			

Revision History

Revision Date	Description of Change
October 24, 2018	<ul style="list-style-type: none"> ▪ Removed "or pin open" from Pin Descriptions ▪ Removed "or open" from Table 8 and Table 9 ▪ Updated Figure 47
October 18, 2018	<ul style="list-style-type: none"> ▪ Updated various logic levels. ▪ Update Typical Performance Characteristics ▪ Completed other minor improvements.
August 29, 2018	Added θ_{JA} and θ_{JC-BOT} values to Table 5.
August 8, 2018	Initial release.



Corporate Headquarters
 6024 Silver Creek Valley Road
 San Jose, CA 95138
www.IDT.com

Sales
 1-800-345-7015 or 408-284-8200
 Fax: 408-284-2775
www.IDT.com/go/sales

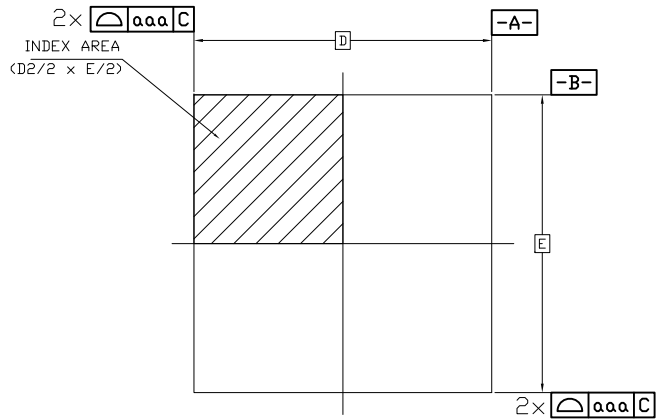
Tech Support
www.IDT.com/go/support

DISCLAIMER Integrated Device Technology, Inc. (IDT) and its affiliated companies (herein referred to as "IDT") reserve the right to modify the products and/or specifications described herein at any time, without notice, at IDT's sole discretion. Performance specifications and operating parameters of the described products are determined in an independent state and are not guaranteed to perform the same way when installed in customer products. The information contained herein is provided without representation or warranty of any kind, whether express or implied, including, but not limited to, the suitability of IDT's products for any particular purpose, an implied warranty of merchantability, or non-infringement of the intellectual property rights of others. This document is presented only as a guide and does not convey any license under intellectual property rights of IDT or any third parties.

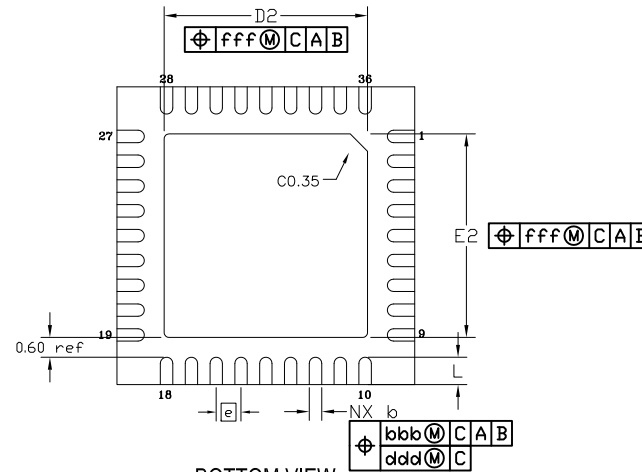
IDT's products are not intended for use in applications involving extreme environmental conditions or in life support systems or similar devices where the failure or malfunction of an IDT product can be reasonably expected to significantly affect the health or safety of users. Anyone using an IDT product in such a manner does so at their own risk, absent an express, written agreement by IDT.

Integrated Device Technology, IDT and the IDT logo are trademarks or registered trademarks of IDT and its subsidiaries in the United States and other countries. Other trademarks used herein are the property of IDT or their respective third party owners. For datasheet type definitions and a glossary of common terms, visit www.idt.com/go/glossary. All contents of this document are copyright of Integrated Device Technology, Inc. All rights reserved.

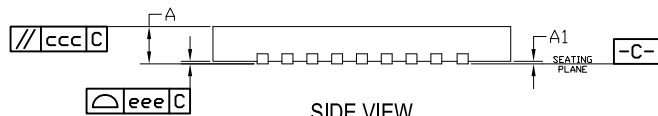
REVISIONS			
REV	DESCRIPTION	DATE	APPROVED
00	INITIAL RELEASE	4/6/16	JH



TOP VIEW



BOTTOM VIEW



SIDE VIEW

SYMBOL	DIMENSION		
	MIN	NOM	MAX
L	0.45	0.55	0.65
D	6.00 BSC		
E	6.00 BSC		
D2	4.00	4.10	4.20
E2	4.00	4.10	4.20
e	0.50 BSC		
A	0.70	0.75	0.80
A1	0.00	0.02	0.05
b	.20	.25	.30
aaa	0.15		
bbb	0.10		
ccc	0.10		
ddd	0.05		
eee	0.08		
fff	0.10		

NOTES:

1. ALL DIMENSIONING AND TOLERANCING CONFORM TO ANSI Y14.5M-1982
2. ALL DIMENSIONS ARE IN MILLIMETERS.

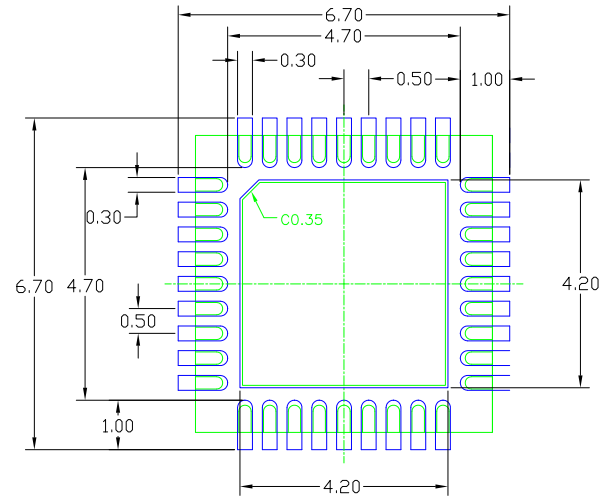
TOLERANCES
UNLESS SPECIFIED
DECIMAL ANGULAR
X ± .1 ± 1°
XX ± .05
XXX ± .030



6024 SILVER CREEK
VALLEY ROAD, SAN JOSE,
CA 95138
PHONE: (408) 284-8200
FAX: (408) 284-3572

APPROVALS	DATE	TITLE
	4/6/16	NB/NBG36 PACKAGE OUTLINE
		6.0 x 6.0 mm BODY, EPAD 4.10 mm SQ
		0.50 mm PITCH QFN
		SIZE DRAWING No.
		C PSC-4311-02
		REV
		00
DO NOT SCALE DRAWING		SHEET 1 OF 2


REVISIONS			
REV	DESCRIPTION	DATE	APPROVED
00	INITIAL RELEASE	4/6/16	JH



RECOMMENDED LAND PATTERN DIMENSION

NOTES:

1. ALL DIMENSIONS ARE IN mm. ANGLES IN DEGREES.
2. TOP DOWN VIEW, AS VIEWED ON PCB.
3. COMPONENT OUTLINE SHOWS FOR REFERENCE IN GREEN.
4. LAND PATTERN IN BLUE. NSMD PATTERN ASSUMED.
5. LAND PATTERN RECOMMENDATION PER IPC-7351B GENERIC REQUIREMENT FOR SURFACE MOUNT DESIGN AND LAND PATTERN.

TOLERANCES UNLESS SPECIFIED		 www.IDT.com		6024 SILVER CREEK VALLEY ROAD. SAN JOSE, CA 95138 PHONE: (408) 284-8200 FAX: (408) 284-3572	
DECIMAL	ANGULAR				
X± .1	±1°	APPROVALS			
XX± .05		DATE	TITLE NB/NBG36 PACKAGE OUTLINE		
XXX± .030		4/6/16	6.0 x 6.0 mm BODY, EPAD 4.10 mm SQ		
DRAWN <i>oac</i>		CHECKED		0.50 mm PITCH QFN	
		SIZE	DRAWING No.	REV	
		C	PSC-4311-02	00	
DO NOT SCALE DRAWING				SHEET 2 OF 2	