

4

3

2



1

THIS DRAWING IS UNPUBLISHED. RELEASED FOR PUBLICATION .19
 © COPYRIGHT 19 BY AMP INCORPORATED, ALL RIGHTS RESERVED.

LOC	DIST	REVISIONS					
DF	A0	P	LTR	DESCRIPTION	DATE	DWN	APVD
		A		REV PER 0600-7187-98	9/10/98	JY	DM

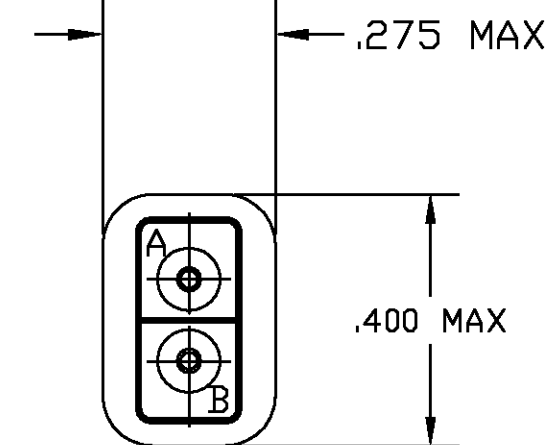
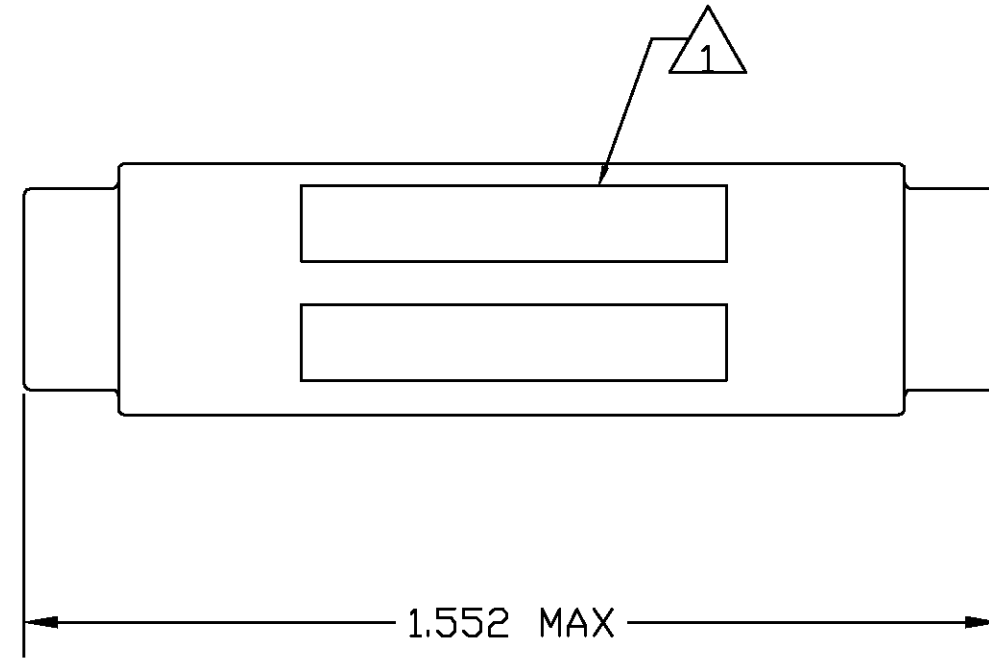
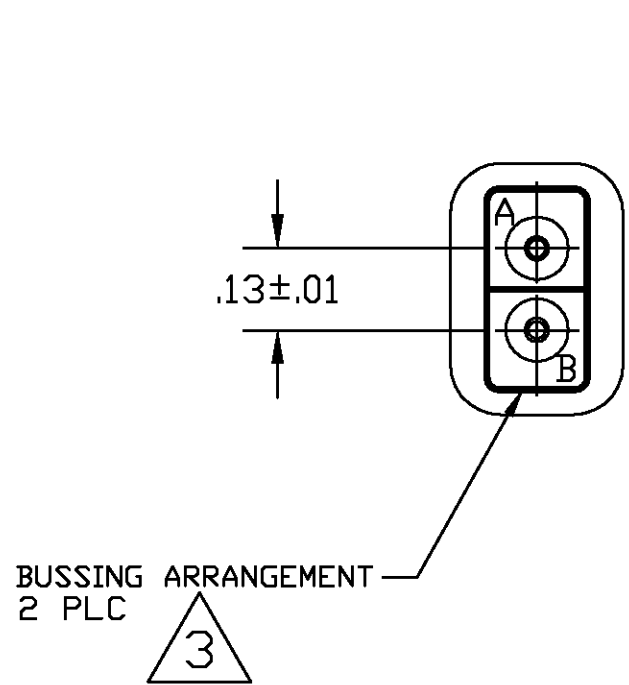
DESCRIPTION	MATERIAL	FINISH
GROMMET	FLUOROSILICONE 40/50 BLEND PER MIL-R-25988	COLOR: BLUE
SPLICE ASSEMBLY HOUSING	EPOXY	COLOR: BLACK
CONTACT FEMALE SOCKET	BERYLLIUM COPPER ASTM-B194	GOLD PLATE PER MIL-G-45204
CLIP CONTACT RETAINING	BERYLLIUM COPPER ASTM-B194 OR STAINLESS STEEL PER QQ-S-766	NONE
SHRINK TUBE	PER MIL-1-23053/8	COLOR TRANSPARENT
CONTACTS 	PER M39029/1-101	GOLD PLATE PER MIL-G-45204



-  MARK WIRE SPLICE BUSSING ARRANGEMENT BOTH ENDS AS SHOWN.
-  A QUANTITY OF 4 CONTACTS ARE SUPPLIED WITH WIRE SPLICE.
-  MARK WIRE SPLICE WITH "AMP", AMP PART NO. AND DATE CODE .060 MINIMUM HIGH CHARACTERS AT APPROXIMATE AREA SHOWN.

---	592589-2
	592589-1
SPECIAL REQUIREMENTS	PART NO.

THIS DRAWING IS A CONTROLLED DOCUMENT		JWN N. FRITZ 03-01-95	AMP AMP Incorporated Harrisburg PA 17105-3608
DIMENSIONS: INCHES		CHK R. RYAN 03-02-95	
TOLERANCES UNLESS OTHERWISE SPECIFIED:		APVD R. RYAN 03-02-95	
MATERIAL: SEE TABLE		FINISH: SEE TABLE	
WEIGHT: -		SCALE: 2:1	RESTRICTED TO: -
CUSTOMER DRAWING		SIZE: A2	CAGE CODE: 00779
		DRAWING NO: C=592589	SHEET 1 OF 1
		REV: A	

592589
B