

Detection from both left and right directions contributes to improved and flexible design of the set mechanism

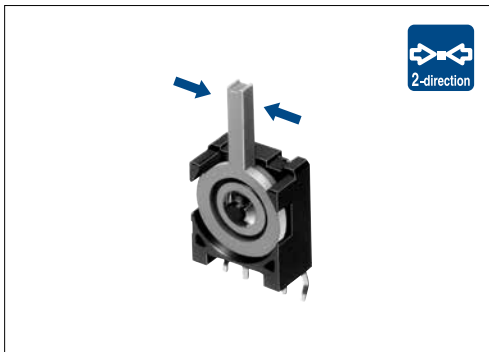

Typical Specifications



Items		Specifications
Rating (max.)/(min.) (Resistive load)		0.1A 12V DC / 50μA 3V DC
Contact resistance (Initial / After operating life)		100mΩ max. / 300mΩ max.
Operating force		0.7N max.
Operating life	Without load	50,000cycles
	With load	50,000cycles (0.1A 12V DC)

Product Line

Poles	Positions	Changeover timing	Terminal type	Mounting method	Minimum order unit (pcs)		Product No.	Drawing No.
					Japan	Export		
1	2	Non shorting	For PC board	PC board	600	3,000	SSCF110100	1
				Screw			SSCF210100	2
			For Lead	SSCF210300			3	
			For PC board	PC board with hook			SSCF310100	4

Packing Specifications









Bulk

Number of packages (pcs.)		Export package measurements (mm)
1 case /Japan	1 case /export packing	
600	3,000	400×270×290

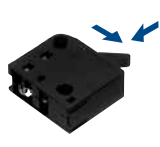
Dimensions

Unit:mm

No.	Photo	Style	PC board mounting hole dimensions
1			

Series		General-purpose Type			
		SSCT	SSCF	SSCW	SSCL
Photo					
Operation type		Two-way			
Dimensions (mm)	W	12.5	11	13.1	11
	D	5	5.8	11.35	16.1
	H	11.5	12.4	5.3	
Operating temperature range		-40°C to +85°C			
Automotive use		●	●	●	●
Life cycle (availability)					
Poles / Positions		1/2		1/1	1/2
Rating (max.) (Resistive load)		0.1A 12V DC			
Rating (min.) (Resistive load)		50µA 3V DC		100µA 3V DC	50µA 5V DC
Durability	Operating life without load	10,000cycles 500mΩ max.	50,000cycles 300mΩ max.	100,000cycles 1Ω max.	50,000cycles 1Ω max.
	Operating life with load Rating (max.) (Resistive load)	10,000cycles 500mΩ max.	50,000cycles 300mΩ max.	100,000cycles 1Ω max.	50,000cycles 1Ω max.
Electrical performance	Initial contact resistance	200mΩ max.	100mΩ max.	500mΩ max.	
	Insulation resistance	100MΩ min. 250V DC	100MΩ min. 100V DC	100MΩ min. 250V DC	100MΩ min. 100V DC
	Voltage proof	250V AC for 1minute	100V AC for 1 minute	250V AC for 1minute	100V AC for 1minute
Mechanical performance	Terminal strength	3N for 1minute	5N for 1minute	—	
	Actuator strength	20N	10N	20N	10N
Environmental performance	Cold	-40°C 500h			
	Dry heat	85°C 500h			
	Damp heat	60°C, 90 to 95%RH 500h			
Operation force		0.7±0.3N	0.7N max.	1N max.	0.7N max.
Page		38	39	41	42

Detector Switches Soldering Conditions	66
Detector Switches Cautions	67

Note
● Indicates applicability to all products in the series.

Example of Reflow Soldering Condition

1. Heating method: Double heating method with infrared heater.
2. Temperature measurement: Thermocouple $\phi 0.1$ to 0.2 CA (K) or CC (T) at soldering portion (copper foil surface).
A heat resisting tape should be used for fixed measurement.
3. Temperature profile

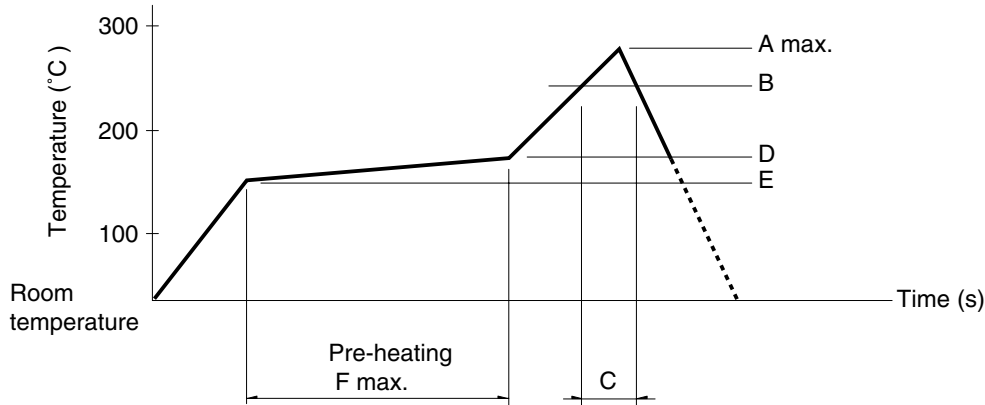

Series (Reflow type)	A (°C) 3s max.	B (°C)	C (s)	D (°C)	E (°C)	F (s)
SPPB	250	230	40	180	150	120
SPVE	260		40			
SPVL						
SPVM						
SPVN						
SPVR						
SPVS						
SPVT						
SSCM						
SSCQ						
SPVQC	250					

Notes

1. The condition mentioned above is the temperature on the mounting surface of a PC board. There are cases where the PC board's temperature greatly differs from that of the switch, surface depending on the PC board's material, size, thickness, etc.
The above-stated conditions shall also apply to switch surface temperatures.
2. Soldering conditions differ depending on reflow soldering machines.
Prior verification of soldering condition is highly recommended.

Reference for Hand Soldering

Series	Soldering temperature	Soldering time
SPVS, SPVN, SPVT, SPVM, SPVR, SPVE, SSCQ, SSCM, SPVL, SSCT, SPVQC	350±5°C	3s max.
SPVQ1, SPVQ3, SPVQ6, SPVQ7, SPVQ8, SPVQ9, SSCN, SPVQA	300±10°C	3 + 1 / 0s
SPPB (Reflow)	300±5°C	5s max.
SSCF, SPPB (For Lead, Dip)	350±10°C	3 + 1 / 0s

Reference for Dip Soldering (For PC board terminal types)

Series	Items		Dip soldering	
	Preheating temperature	Preheating time	Soldering temperature	Duration of immersion
SSCT, SPVQ1, SPVQ3, SPVQ6, SPVQ7, SPVQ8, SPVQ9, SPVQA	100±10°C	60s max.	260±5°C	5±1s
SPPW8, SPPB	100°C max.	60s max.	255±5°C	5±1s
SSCF	—		260±5°C	5±1s