



# ST3243EB ST3243EC

± 15 kV ESD protected 3 to 5.5 V, 400 kbps, RS-232 transceiver with auto power-down

## Features

- ESD protection for RS-232 I/O pins:
  - ± 8 kV IEC 1000-4-2 contact discharge
  - ± 15 kV human body model
- 1 µA supply current achieved when in auto power-down
- 250 kbps minimum guaranteed data rate
- Guaranteed 6 V/ms slew rate range
- Guaranteed mouse drive ability
- 0.1 µF external capacitors
- Meet EIA/TIA-232 specifications down to 3 V
- Available in TSSOP28 package

## Description

The ST3243E device consists of 3 drivers, 5 receivers and a dual charge-pump circuit. The device meets the requirements of EIA/TIA and V.28/V.24 communication standards providing high data rate capability and enhanced electrostatic discharge (ESD) protection. All transmitter outputs and receiver input are protected to ± 8 kV USING IEC 1000-4-2 contact discharge and ± 15 kV using the human body model. The receiver R2 is always active to implement a wake-up feature for serial port.

The ST3243E has a proprietary low-dropout transmitter output stage enabling true RS-232 performance from a 3.0 V to 5.5 V supply with a dual charge pump. The device is guaranteed to run at data rates of 250 kbps while maintaining RS-232 output levels.

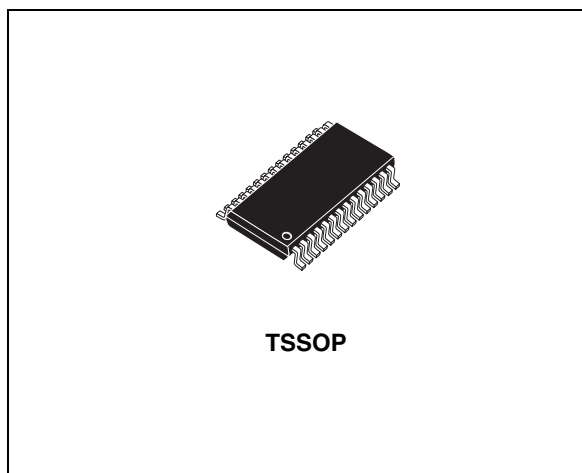

The auto power-down feature functions when FORCEON is low and FORCEOFF is high. During this mode of operation, if the device does not sense a valid RS-232 signal, the driver outputs are disabled. If FORCEOFF is set low, both drivers and receivers (except R2B) are shut off, and supply current is reduced to 1 µA. Disconnecting the serial port or turning off the peripheral drives causes the auto power-down condition to occur.

Auto power-down can be disabled when FORCEON and FORCEOFF are high, and should be done when driving a serial mouse. With auto power-down enabled, the device is activated automatically when a valid signal is applied to any receiver input.

Typical application are in notebook, subnotebook, palmtop computers, battery-powered equipment, handheld equipment, peripherals and printers.

Table 1. Device summary

Order codes	Temperature range	Package	Packaging
ST3243ECTR-E	0 to 70 °C	TSSOP28 (tape and reel)	2500 parts per reel
ST3243EBTR	- 40 to 85 °C	TSSOP28 (tape and reel)	2500 parts per reel

# Contents

1	Pin configuration .....	3
2	Truth tables .....	5
3	Maximum ratings .....	6
4	Electrical characteristics .....	7
5	Application circuits .....	10
6	Timing diagrams .....	11
7	Package mechanical data .....	12
8	Revision history .....	15

# 1 Pin configuration

Figure 1. Pin configuration

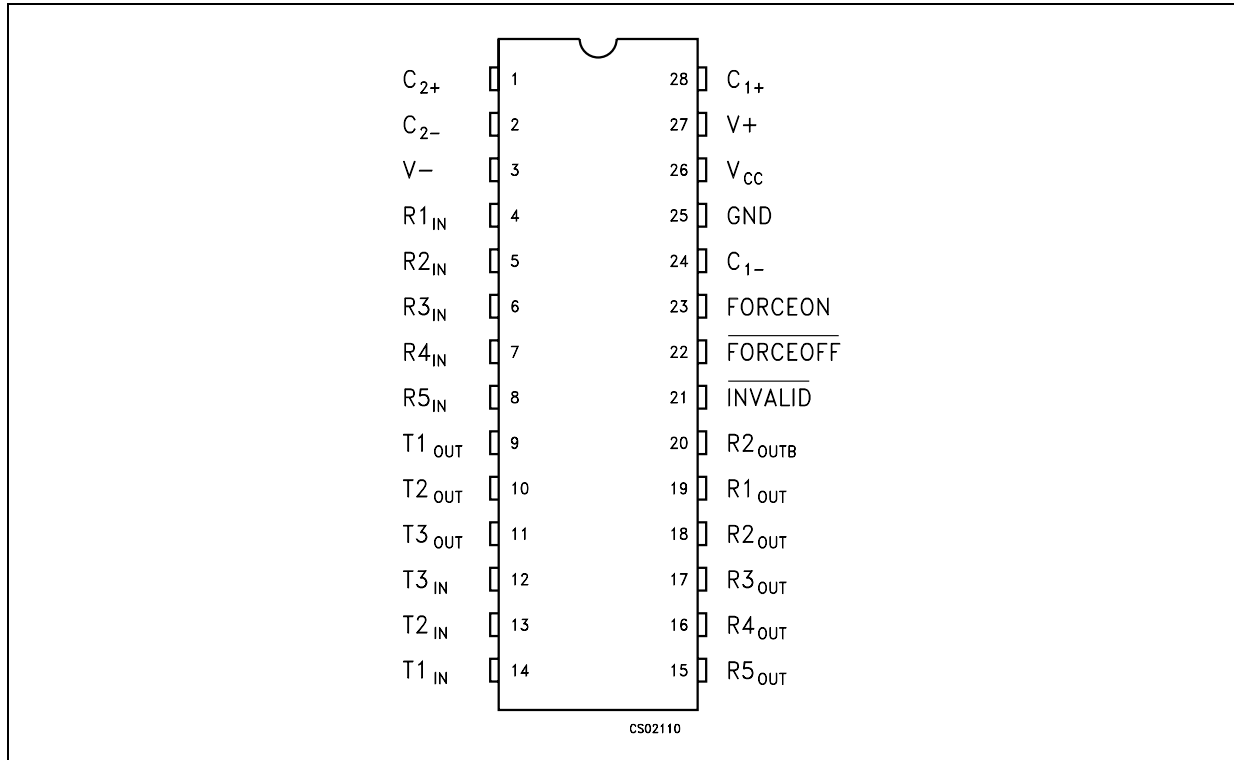

Table 2. Pin description

Pin n°	Symbol	Name and function
1	C <sub>2+</sub>	Positive terminal of inverting charge pump capacitor
2	C <sub>2-</sub>	Negative terminal of inverting charge pump capacitor
3	V-	-5.5 V Generated by the charge pump
4	R1 <sub>IN</sub>	First receiver input voltage
5	R2 <sub>IN</sub>	Second receiver input voltage
6	R3 <sub>IN</sub>	Third receiver input voltage
7	R4 <sub>IN</sub>	Fourth receiver input voltage
8	R5 <sub>IN</sub>	Fifth receiver input voltage
9	T1 <sub>OUT</sub>	First transmitter output voltage
10	T2 <sub>OUT</sub>	Second transmitter output voltage
11	T3 <sub>OUT</sub>	Third transmitter output voltage
12	T3 <sub>IN</sub>	Third transmitter input voltage
13	T2 <sub>IN</sub>	Second transmitter input voltage
14	T1 <sub>IN</sub>	First transmitter input voltage

Table 2. Pin description (continued)

Pin n°	Symbol	Name and function
15	R5 <sub>OUT</sub>	Fifth receiver output voltage
16	R4 <sub>OUT</sub>	Fourth receiver output voltage
17	R3 <sub>OUT</sub>	Third receiver output voltage
18	R2 <sub>OUT</sub>	Second receiver output voltage
19	R1 <sub>OUT</sub>	First receiver output voltage
20	R2 <sub>OUTB</sub>	Non-inverting complementary receiver output, always active for wake-up
21	INVALID	Output of the valid signal detector. Indicates if a valid RS-232 level is present on receiver inputs logic "1"
22	FORCEOFF	Drive low to shut down transmitters and on-board power supply. This over-rides all automatic circuitry and FORCEON
23	FORCEON	Drive high to override automatic circuitry keeping transmitters on (FORCEOFF must be high)
24	C <sub>1-</sub>	Negative terminal of voltage-charge pump capacitor
25	GND	Ground
26	V <sub>CC</sub>	Supply voltage
27	V+	5.5 V Generated by the charge pump
28	C <sub>1+</sub>	Positive terminal of voltage-charge pump capacitor

## 2 Truth tables

**Table 3. Invalid truth table**

RS-232 Signal present at any receiver input	$\overline{\text{INVALID}}$ output
YES	H
NO	L

**Table 4. Output control truth table**

Force ON	Force OFF	Valid receiver level	Operation status	T <sub>OUT</sub>	R <sub>OUT</sub>	R <sub>2OUTB</sub>
X	0	X	Shutdown (Force OFF)	HIGH Z	HIGH Z	ACTIVE
1	1	X	Normal operating (Force ON)	ACTIVE	ACTIVE	ACTIVE
0	1	YES	Normal operating (Auto power-down)	ACTIVE	ACTIVE	ACTIVE
0	1	NO	Shutdown (Auto power-down)	HIGH Z	ACTIVE	ACTIVE

### 3 Maximum ratings

**Table 5. Absolute maximum ratings**

Symbol	Parameter	Value	Unit
$V_{CC}$	Supply voltage	-0.3 to 6	V
V+	Doubled voltage terminal	$(V_{CC} - 0.3)$ to 7	V
V-	Inverted voltage terminal	0.3 to -7	V
$V_{+ + V- }$		13	V
FORCEON, FORCEOFF, $T_{IN}$	Input voltage	-0.3 to 6	V
$R_{IN}$	Receiver input voltage range	$\pm 25$	V
$T_{OUT}$	Transmitter output voltage range	$\pm 13.2$	V
$R_{OUT}$ $R_{OUTB}$ INVALID	Receiver output voltage range	-0.3 to $(V_{CC} + 0.3)$	V
$t_{SHORT}$	Short circuit duration on $T_{OUT}$ (one at a time)	Continuous	
$T_{stg}$	Storage temperature range	-65 to 150	°C

*Note:* Absolute maximum ratings are those values beyond which damage to the device may occur. Functional operation under these condition is not implied.

**Table 6. ESD performance: transmitter outputs, receiver inputs**

Symbol	Parameter	Test conditions	Min.	Typ.	Max.	Unit
ESD	ESD protection voltage	Human body model	$\pm 15$			kV
ESD	ESD protection voltage	IEC 1000-4-2 (contact discharge)	$\pm 8$			kV

## 4 Electrical characteristics

C1 - C4 = 0.1  $\mu$ F,  $V_{CC}$  = 3 V to 5.5 V,  $T_A$  = -40 to 85  $^{\circ}$ C, unless otherwise specified.  
Typical values are referred to  $T_A$  = 25  $^{\circ}$ C.

**Table 7. Electrical characteristics**

Symbol	Parameter	Test conditions	Min.	Typ.	Max.	Unit
$I_{ASHDN}$	Supply current auto power-down	$\overline{FORCEOFF} = GND, \overline{FORCEON} = V_{CC}$ All R_IN open or grounded		1	10	$\mu$ A
$I_{SUPPLY}$	Supply current	$\overline{FORCEON} = \overline{FORCEOFF} = V_{CC}$		0.3	1	mA
$I_{SHDN}$	Shutdown supply current	$\overline{FORCEOFF} = GND$		1	10	$\mu$ A

C1 - C4 = 0.1  $\mu$ F,  $V_{CC}$  = 3 V to 5.5 V,  $T_A$  = -40 to 85  $^{\circ}$ C, unless otherwise specified.  
Typical values are referred to  $T_A$  = 25  $^{\circ}$ C.

**Table 8. Logic input electrical characteristics**

Symbol	Parameter	Test conditions	Min.	Typ.	Max.	Unit
$V_{TIL}$	Input logic threshold low	T-IN, $\overline{FORCEON}$ , $\overline{FORCEOFF}$			0.8	V
$V_{TIH}$	Input logic threshold high	T-IN, $\overline{FORCEON}$ , $\overline{FORCEOFF}$ $V_{CC} = 3.3$ V $V_{CC} = 5$ V	2 2.4			V V
$V_{THYS}$	Transmitter input hysteresis			0.5		V
$I_{IL}$	Input leakage current	T-IN, $\overline{FORCEON}$ , $\overline{FORCEOFF}$		$\pm 0.01$	$\pm 1.0$	$\mu$ A
$I_{OL}$	Output leakage current	Receiver disabled		$\pm 0.05$	$\pm 10$	$\mu$ A
$V_{OL}$	Output voltage low	$I_{OUT} = 1.6$ mA			0.4	V
$V_{OH}$	Output voltage high	$I_{OUT} = -1$ mA	$V_{CC}-0.6$	$V_{CC}-0.1$		V

C1 - C4 = 0.1  $\mu$ F,  $V_{CC}$  = 3 V to 5.5 V,  $T_A$  = -40 to 85  $^{\circ}$ C, unless otherwise specified.  
 Typical values are referred to  $T_A$  = 25  $^{\circ}$ C, FORCEON = GND, FORCEOFF =  $V_{CC}$ .

**Table 9. Auto power-down electrical characteristics**

Symbol	Parameter	Test conditions	Min.	Typ.	Max.	Unit
$V_{RITE}$	Receiver input threshold to $\overline{INVALID}$ output voltage HIGH (see <a href="#">Figure 3</a> )	Positive threshold			2.7	V
		Negative threshold	2.7			V
$V_{RITD}$	Receiver input threshold to $\overline{INVALID}$ output voltage LOW (see <a href="#">Figure 3</a> )		-0.3		0.3	V
$V_{IOL}$	$\overline{INVALID}$ output voltage LOW	$I_{OUT} = 1.6$ mA			0.4	V
$V_{IOH}$	$\overline{INVALID}$ output voltage HIGH	$I_{OUT} = -1$ mA	$V_{CC}-0.6$			V
$t_{WU}$	Receiver or transmitter edge transmitter enabled (see <a href="#">Figure 3</a> )			100		$\mu$ s
$t_{INVH}$	Receiver positive or negative threshold to $\overline{INVALID}$ HIGH (see <a href="#">Figure 3</a> )			0.2		$\mu$ s
$t_{INVL}$	Receiver positive or negative threshold to $\overline{INVALID}$ LOW (see <a href="#">Figure 3</a> )			30		$\mu$ s

C1 - C4 = 0.1  $\mu$ F,  $V_{CC}$  = 3 V to 5.5 V,  $T_A$  = -40 to 85  $^{\circ}$ C, unless otherwise specified.  
 Typical values are referred to  $T_A$  = 25  $^{\circ}$ C.

**Table 10. Transmitter electrical characteristics**

Symbol	Parameter	Test conditions	Min.	Typ.	Max.	Unit
$V_{TOUT}$	Output voltage swing	All Transmitter outputs are loaded with 3k $\Omega$ to GND	$\pm 5$	$\pm 5.4$		V
$R_{OUT}$	Output resistance	$V_{CC} = V+ = V- = 0$ V, $V_{OUT} = \pm 2$ V	300	10M		$\Omega$
$I_{SC}$	Output short circuit current	$V_{CC} = 3.3$ V		$\pm 40$	$\pm 60$	mA
$I_L$	Output leakage current	$V_{CC} = 0$ to 5.5V, transmitter output = $\pm 12$ V, transmitter disabled			$\pm 25$	$\mu$ A
$V_{OT}$	Transmitter output voltage	T1IN = T2IN = GND, T3IN = $V_{CC}$ T3OUT loaded with 3 k $\Omega$ to GND T1OUT and T2OUT loaded with 2.5mA each	$\pm 5$			V



C1 - C4 = 0.1  $\mu$ F,  $V_{CC}$  = 3 V to 5.5 V,  $T_A$  = -40 to 85 °C, unless otherwise specified.  
 Typical values are referred to  $T_A$  = 25 °C.

**Table 11. Receiver electrical characteristics**

Symbol	Parameter	Test conditions	Min.	Typ.	Max.	Unit
$V_{RIN}$	Receiver input voltage operating range		-25		25	V
$V_{RIL}$	RS-232 Input threshold low	$T_A = 25^\circ\text{C}$ , $V_{CC} = 3.3\text{ V}$ $T_A = 25^\circ\text{C}$ , $V_{CC} = 5.0\text{ V}$	0.6 0.8	1.1 1.4		V
$V_{RIH}$	RS-232 Input threshold high	$T_A = 25^\circ\text{C}$ , $V_{CC} = 3.3\text{ V}$ $T_A = 25^\circ\text{C}$ , $V_{CC} = 5.0\text{ V}$		1.6 1.9	2.4 2.4	V
$V_{RIHYS}$	Input hysteresis			0.5		V
$R_{RIN}$	Input resistance	$T_A = 25^\circ\text{C}$	3	5	7	k $\Omega$

C1 - C4 = 0.1  $\mu$ F,  $V_{CC}$  = 3 V to 5.5 V,  $T_A$  = -40 to 85 °C, unless otherwise specified.  
 Typical values are referred to  $T_A$  = 25 °C.

**Table 12. Timing characteristics**

Symbol	Parameter	Test conditions	Min.	Typ.	Max.	Unit
$D_R$	Maximum data rate	$R_L = 3\text{k}\Omega$ , $C_L = 1000\text{ pF}$ one transmitter switching	250	400		kbps
$t_{PHL}$ $t_{PLH}$	Receiver propagation delay	$R_{IN}$ to $R_{OUT}$ , $C_L = 150\text{ pF}$		0.15		$\mu$ s
$t_{T\_SKEW}$	Transmitter skew			150		ns
$t_{R\_SKEW}$	Receiver skew			70		ns
$S_{RT}$	Transition slew rate	$T_A = 25^\circ\text{C}$ $R_L = 3\text{k}$ to $7\text{k}\Omega$ , $V_{CC} = 3.3\text{ V}$ measured from +3 V to -3 V or -3 V to +3 V $C_L = 150\text{ pF}$ to $1000\text{ pF}$ $C_L = 150\text{ pF}$ to $2500\text{ pF}$	6 4		30 30	V/ $\mu$ s V/ $\mu$ s

# 5 Application circuits

Figure 2. Application circuits

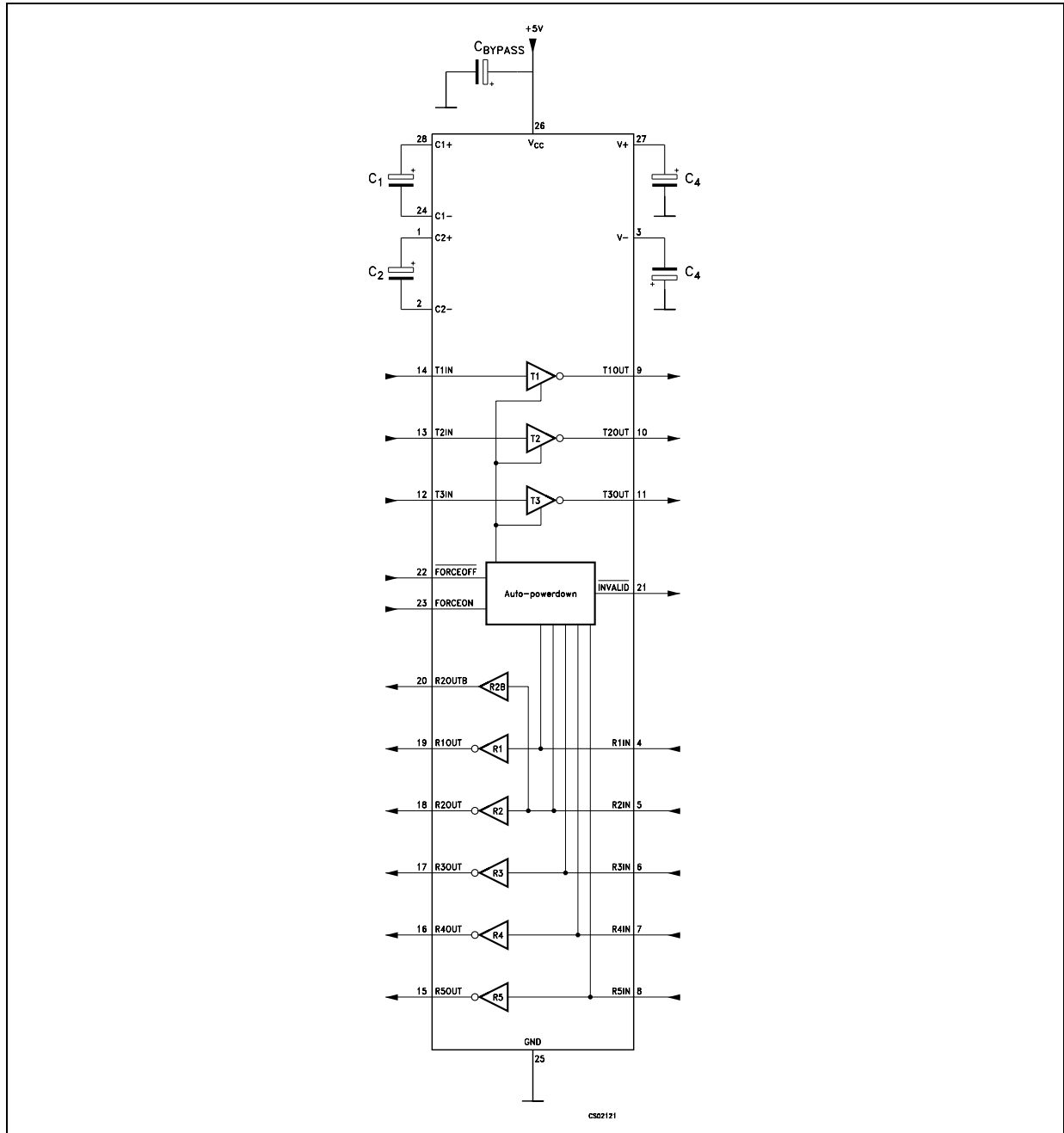

Table 13. Required minimum capacitance value (μF)

V <sub>CC</sub> (V)	C <sub>1</sub>	C <sub>2</sub> , C <sub>3</sub> , C <sub>4</sub> , C <sub>BYPASS</sub>
3 to 3.6	0.1	0.1
4.5 to 5.5	0.047	0.33

## 6 Timing diagrams

Figure 3. Auto power-down input levels

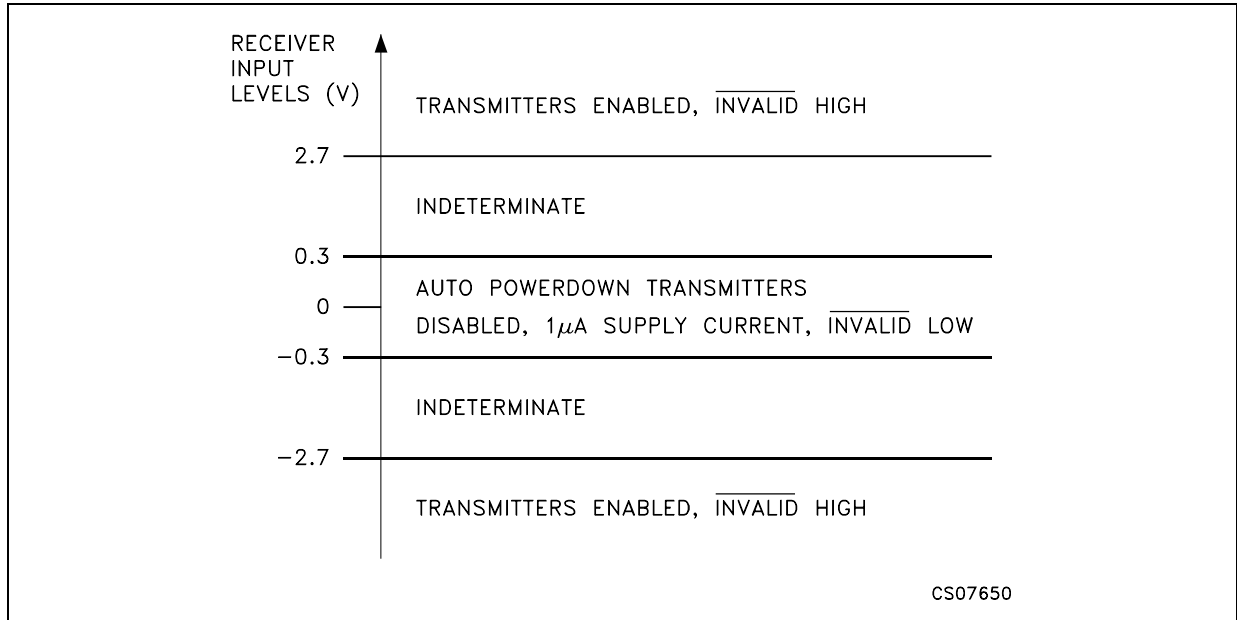
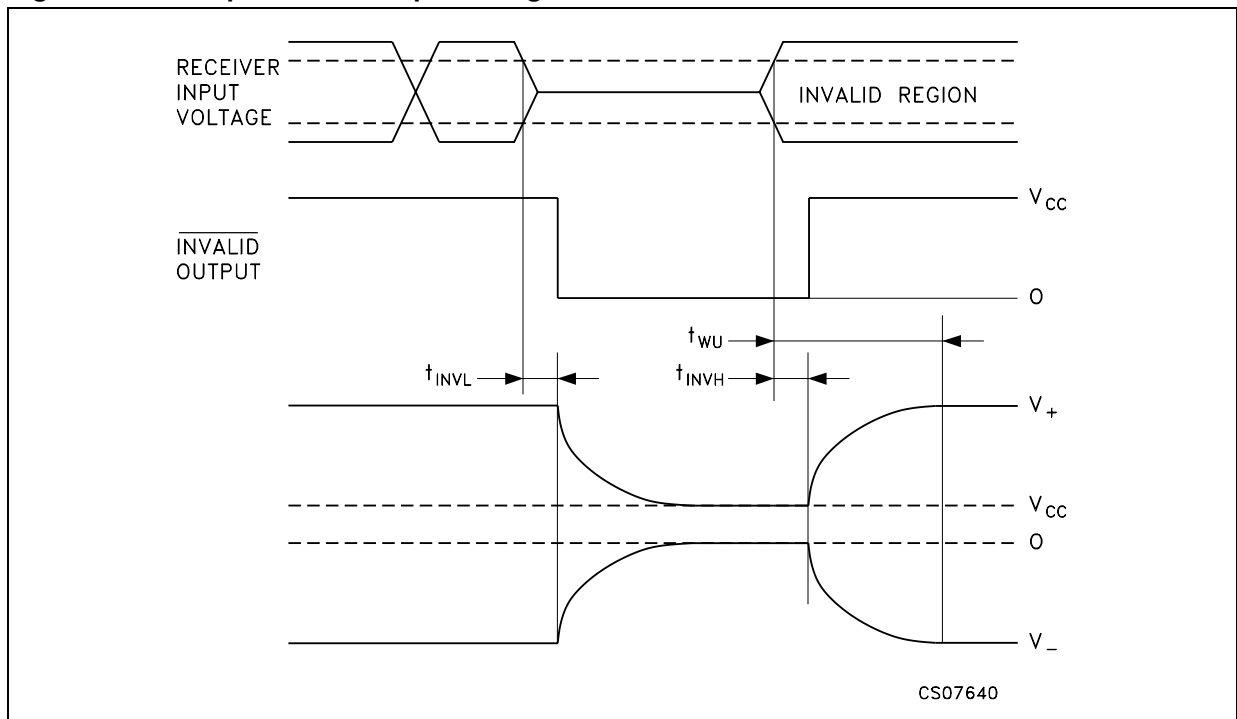

Figure 4. Auto power-down input timing



## 7 Package mechanical data

In order to meet environmental requirements, ST offers these devices in different grades of ECOPACK<sup>®</sup> packages, depending on their level of environmental compliance. ECOPACK<sup>®</sup> specifications, grade definitions and product status are available at: [www.st.com](http://www.st.com). ECOPACK<sup>®</sup> is an ST trademark.

**TSSOP28 mechanical data**

Dim.	mm.			inch.		
	Min.	Typ.	Max.	Min.	Typ.	Max.
A			1.2			0.047
A1	0.05		0.15	0.002	0.004	0.006
A2	0.8	1	1.05	0.031	0.039	0.041
b	0.19		0.30	0.007		0.012
c	0.09		0.20	0.004		0.0079
D	9.6	9.7	9.8	0.378	0.382	0.386
E	6.2	6.4	6.6	0.244	0.252	0.260
E1	4.3	4.4	4.48	0.169	0.173	0.176
e		0.65 BSC			0.0256 BSC	
K	0°		8°	0°		8°
L	0.45	0.60	0.75	0.018	0.024	0.030

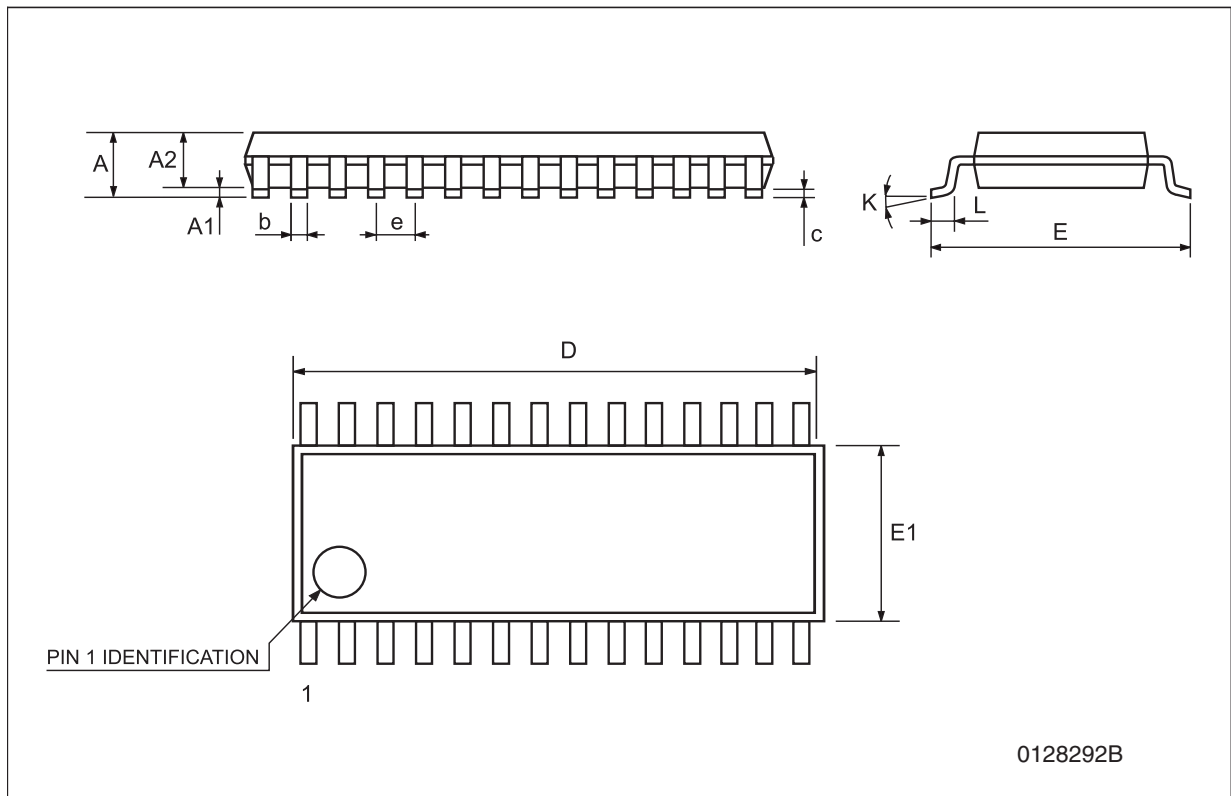

**Tape & reel TSSOP28 mechanical data**

Dim.	mm.			inch.		
	Min.	Typ.	Max.	Min.	Typ.	Max.
A			330			12.992
C	12.8		13.2	0.504		0.519
D	20.2			0.795		
N	60			2.362		
T			22.4			0.882
Ao	6.8		7	0.268		0.276
Bo	10.1		10.3	0.398		0.406
Ko	1.7		1.9	0.067		0.075
Po	3.9		4.1	0.153		0.161
P	11.9		12.1	0.468		0.476

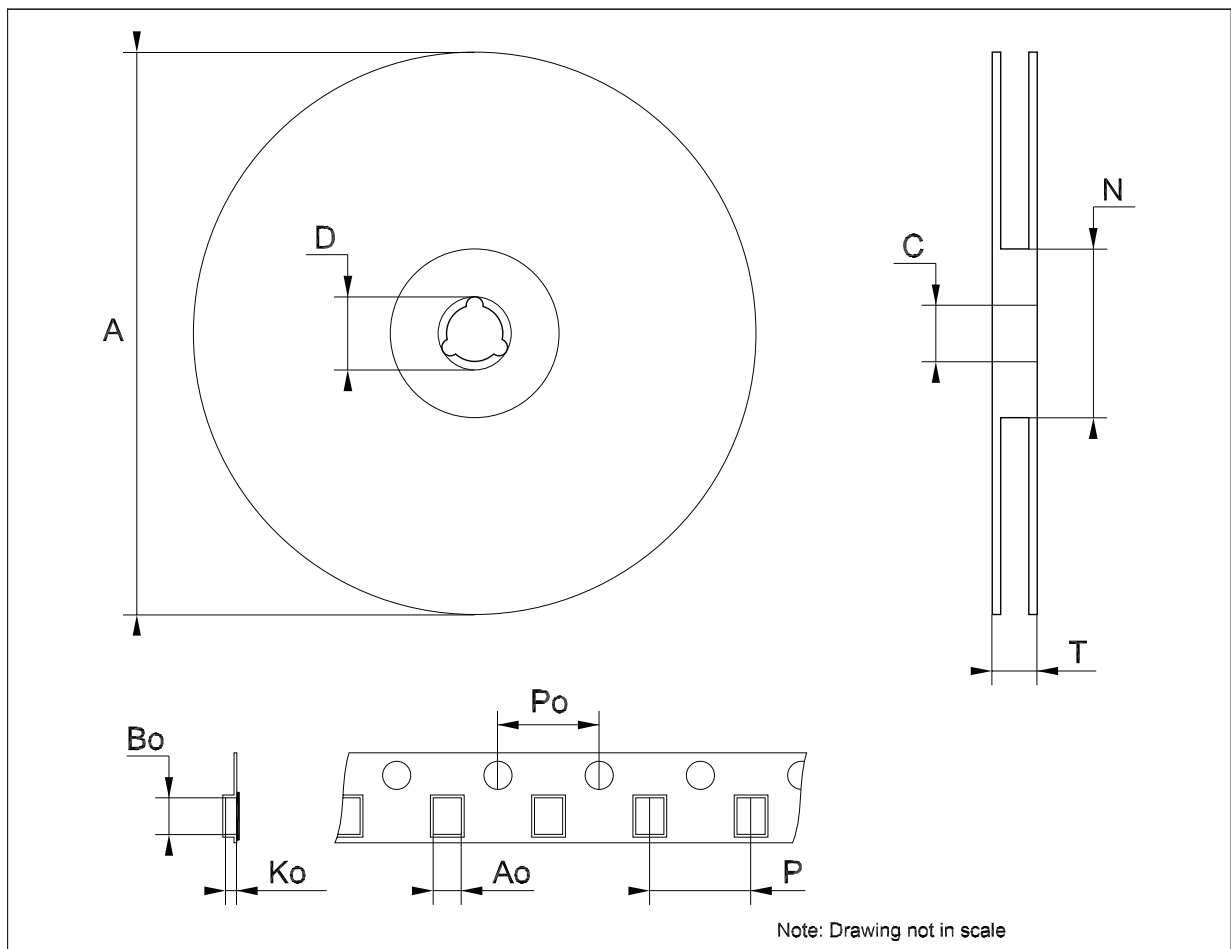

## 8 Revision history

**Table 14. Document revision history**

Date	Revision	Changes
21-Jun-2004	6	Page 6 - $I_L$ (output leakage current) mA ==> $\mu A$
31-Mar-2006	7	Order codes updated and new template.
25-Oct-2006	8	Order codes updated.
24-Aug-2007	9	Order codes updated.
09-Jul-2008	10	Removed: SO-28 and SSOP28 packages.
28-Jul-2009	11	Removed: Flip-chip28 package, modified <a href="#">Table 1 on page 1</a> .
16-Oct-2009	12	Modified <a href="#">Table 9 on page 8</a> .

**Please Read Carefully:**

Information in this document is provided solely in connection with ST products. STMicroelectronics NV and its subsidiaries ("ST") reserve the right to make changes, corrections, modifications or improvements, to this document, and the products and services described herein at any time, without notice.

All ST products are sold pursuant to ST's terms and conditions of sale.

Purchasers are solely responsible for the choice, selection and use of the ST products and services described herein, and ST assumes no liability whatsoever relating to the choice, selection or use of the ST products and services described herein.

No license, express or implied, by estoppel or otherwise, to any intellectual property rights is granted under this document. If any part of this document refers to any third party products or services it shall not be deemed a license grant by ST for the use of such third party products or services, or any intellectual property contained therein or considered as a warranty covering the use in any manner whatsoever of such third party products or services or any intellectual property contained therein.

**UNLESS OTHERWISE SET FORTH IN ST'S TERMS AND CONDITIONS OF SALE ST DISCLAIMS ANY EXPRESS OR IMPLIED WARRANTY WITH RESPECT TO THE USE AND/OR SALE OF ST PRODUCTS INCLUDING WITHOUT LIMITATION IMPLIED WARRANTIES OF MERCHANTABILITY, FITNESS FOR A PARTICULAR PURPOSE (AND THEIR EQUIVALENTS UNDER THE LAWS OF ANY JURISDICTION), OR INFRINGEMENT OF ANY PATENT, COPYRIGHT OR OTHER INTELLECTUAL PROPERTY RIGHT.**

**UNLESS EXPRESSLY APPROVED IN WRITING BY AN AUTHORIZED ST REPRESENTATIVE, ST PRODUCTS ARE NOT RECOMMENDED, AUTHORIZED OR WARRANTED FOR USE IN MILITARY, AIR CRAFT, SPACE, LIFE SAVING, OR LIFE SUSTAINING APPLICATIONS, NOR IN PRODUCTS OR SYSTEMS WHERE FAILURE OR MALFUNCTION MAY RESULT IN PERSONAL INJURY, DEATH, OR SEVERE PROPERTY OR ENVIRONMENTAL DAMAGE. ST PRODUCTS WHICH ARE NOT SPECIFIED AS "AUTOMOTIVE GRADE" MAY ONLY BE USED IN AUTOMOTIVE APPLICATIONS AT USER'S OWN RISK.**

Resale of ST products with provisions different from the statements and/or technical features set forth in this document shall immediately void any warranty granted by ST for the ST product or service described herein and shall not create or extend in any manner whatsoever, any liability of ST.

ST and the ST logo are trademarks or registered trademarks of ST in various countries.

Information in this document supersedes and replaces all information previously supplied.

The ST logo is a registered trademark of STMicroelectronics. All other names are the property of their respective owners.

© 2009 STMicroelectronics - All rights reserved

STMicroelectronics group of companies

Australia - Belgium - Brazil - Canada - China - Czech Republic - Finland - France - Germany - Hong Kong - India - Israel - Italy - Japan - Malaysia - Malta - Morocco - Philippines - Singapore - Spain - Sweden - Switzerland - United Kingdom - United States of America

[www.st.com](http://www.st.com)