



Certifications & Ratings

- RoHS compliant

Application

The 616 Series LED Panel Mount Indicators are designed for a variety of applications such as:

- Main power indication
 - Remote power indication
 - Status indication
 - Maintenance and warning indication
 - Instrumentation
- ... and many more!

Dimensions

inches [mm]

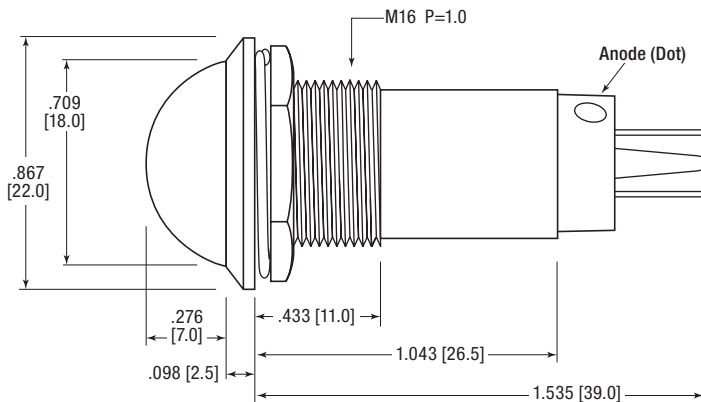

Mechanical Information

- Mounting Hole Size:** 0.642" (16.3 mm)
- Max Panel Thickness:** 0.236" (6.0 mm)
- Mounting Torque:** 0.217 lbs/ft (3 kg/cm)

Specifications

- Voltage Options:** 6, 12 & 24VDC (no resistor required)
- Operating Temp:** -25 °C to +85 °C (-13 °F to +185 °F)
- Storage Temp:** -25 °C to +100 °C (-13 °F to +212 °F)
- Electrical Connection:** Solder terminals
- Housing:** Polycarbonate
- Terminals:** Copper—Nickel Plated
- Lock Washer:** Iron—Nickel Plated
- Nut:** Brass—Nickel Plated

Ordering Information 616 Series

| Part Number | Color | Voltage (V DC) | Current (mA) | Intensity Typ. (mcd) |
|---------------|--------|----------------|--------------|----------------------|
| 612-1132-120F | Red | 6 | 15 | 60 |
| 612-1232-120F | Green | | | 110 |
| 612-1332-120F | Yellow | | | 90 |
| 612-1132-130F | Red | 12 | | 60 |
| 612-1232-130F | Green | | | 110 |
| 612-1332-130F | Yellow | | | 90 |
| 612-1132-140F | Red | 24 | | 60 |
| 612-1232-140F | Green | | | 110 |
| 612-1332-140F | Yellow | | | 90 |

Dialight reserves the right to make changes at any time in order to supply the best product possible. The most current version of this document will always be available at: www.dialightsignalsandcomponents.com

Warranty Statement: Except for the warranty expressly provided for [herein/above/below], Dialight disclaims any and all other warranties, express or implied, including, without limitation, any warranties of merchantability, fitness for a particular purpose, title, and noninfringement.

