

ADVANTECH

ADVANTECH

DRAM Memory Module

Portfolio Introduction

PAPS Product Management
Q3 / 2013

PART I.

**ADVANTECH QUALIFIED DIMM
(AQD)**

ADVANTECH QUALIFIED DIMM

Built to Last ---

The toughest memory module for rigorous applications



QUALITY



RELIABILITY

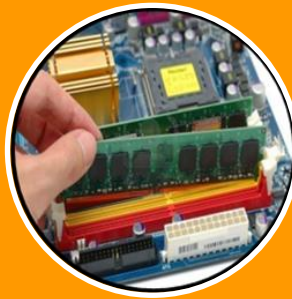

COMPATIBILITY



LONGEVITY



LIFE-TIME WARRANTY



Quality Assurance

Rigorous Reliability Tests

Cross-Checked Compatibility

Longevity

Life-Time Warranty

Quality Assurance Program

Carefully Selected Premium Materials

ISO-9000 Manufacturing Process

Industrial Testing Standard

Quality Assurance

**Rigorous
Reliability
Tests**

Cross-Checked
Compatibility

Longevity

Life-Time Warranty

100% Module
On Board
Testing

Vibration
Test

Chamber Test

Functional Test

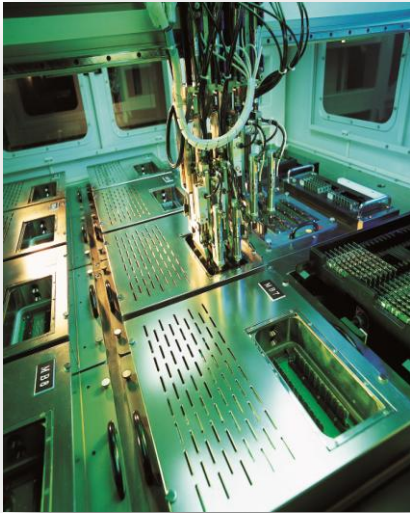

Quality Assurance

Rigorous Reliability Tests

Cross-Checked Compatibility

Longevity

Life-Time Warranty

Motherboard Team
DOA Testing Result

Memory Compatibility
Testing Result

Check & Compare
Both Teams Testing Result to
Ensure M/B vs. Memory
Compatibility



| Part No | 9603-1G1069N-N-AP | 9603-1G1069N-N-TR | 9603-2C1069N-N-AP | 9603-2C1069N-N-TR | 9603-4G1069N-N-AP | 9603-1G1333N-N-AP | 9603-1G1333N-N-AP1 | 9603-1G1333N-N-SA | 9603-1G1333N-N-TR | 9603-1G1333N-N-TR1 | 9603-2C1333N-N-AP |
|------------------|-------------------|-------------------|-------------------|-------------------|-------------------|-------------------|--------------------|-------------------|-------------------|--------------------|-------------------|
| ARK-DS302-S6A1E | | | | | | | | | | | |
| ARK-DS302-S6A1E | | | | | | | | | | | |
| ARK-DS302-S6A2E | | | | | | | | | | | |
| ARK-DS302-S6A2E | | | | | | | | | | | |
| ARK-DS350-00A1E | | | | | | | | | | | |
| ARK-DS350-00B1E | | | | | | | | | | | |
| ARK-DS350-U0A1E | | | | | | | | | | | |
| ARK-DS350-U2A1E | | | | | | | | | | | |
| ARK-DS350-U7B1E | | | | | | | | | | | |
| ARK-DS350-USB1E | | | | | | | | | | | |
| ASMB-310-00A1E | | | | | | | | | | | |
| ASMB-310R-00A1E | | | | | | | | | | | |
| ASMB-781G2-00A1E | x | x | x | x | x | x | x | x | x | x | x |
| ASMB-781G4-00A1E | x | x | x | x | x | x | x | x | x | x | x |
| ASMB-920-00A1E | | | | | | | | | | | |
| ASMB-920R-00A1E | | | | | | | | | | | |
| FWA-3210A | | | | | | | | | | | |
| FWA-3210B | | | | | | | | | | | |
| FWA-6500BE | | | | | | | | | | | |

Quality Assurance

Rigorous Reliability
Tests

Cross-Checked
Compatibility

Longevity

Life-Time Warranty

Locked BOM

- IC Spec
- PCB Layout



**Minimum
3 Years
Longevity**

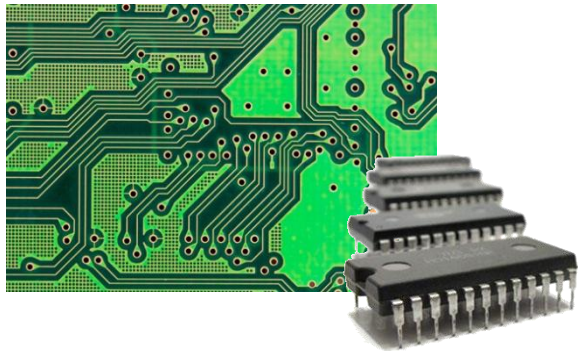

Quality Assurance

Rigorous Reliability
Tests

Cross-Checked
Compatibility

Longevity

Life-Time Warranty

**Every ADVATECH QUALIFIED
DIMM (AQD) is back up by life-
time warranty.**



AQD Product Portfolio



Unbuffered DIMM

- * General IPC Applications
- * 1GB, 2GB, 4GB & 8GB

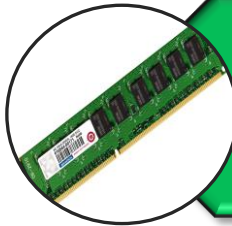

ECC Unbuffered DIMM

- * Improve system productivity and efficiency
- * 4GB & 8GB

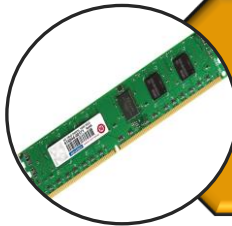

Registered DIMM

- * Providing the best solution for capacity and performance requirement.
- * 8 GB & 16GB

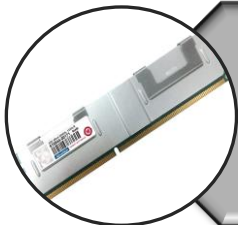

Load Reduce DIMM

- * Providing the biggest capacity per server with the lowest energy costs
- * 32GB

AQD Products Offering

**LONG & SHORT
Unbuffered DIMM**

LONG DIMM
DDR3-1333
1G



AQD-D31GN13-SX

LONG DIMM
DDR3-1600
2G



AQD-D3L2GN16-SQ

LONG DIMM
DDR3-1600
4G



AQD-D3L4GN16-SQ

LONG DIMM
DDR3-1600
8G



AQD-D3L8GN16-SQ

SHORT DIMM
DDR3-1333
1G



AQD-SD31GN13-SX

SHORT DIMM
DDR3-1600
2G



AQD-SD3L2GN16-SQ

SHORT DIMM
DDR3-1600
4G



AQD-SD3L4GN16-SG

SHORT DIMM
DDR3-1600
8G



AQD-SD3L8GN16-SG

ECC Unbuffered DIMM

LONG DIMM
DDR3-1600
4G



AQD-D3L4GE16-SG

LONG DIMM
DDR3-1600
8G



AQD-D3L8GE16-SG

Load Reduce DIMM

DDR3-1333
32G



AQD-D3L32L13-SM

Registered DIMM

LONG DIMM
DDR3-1600
8G



AQD-D3L8GRV16-SG

LONG DIMM
DDR3-1600
16GB



AQD-D3L16RV16-SM

Part Number Decoder

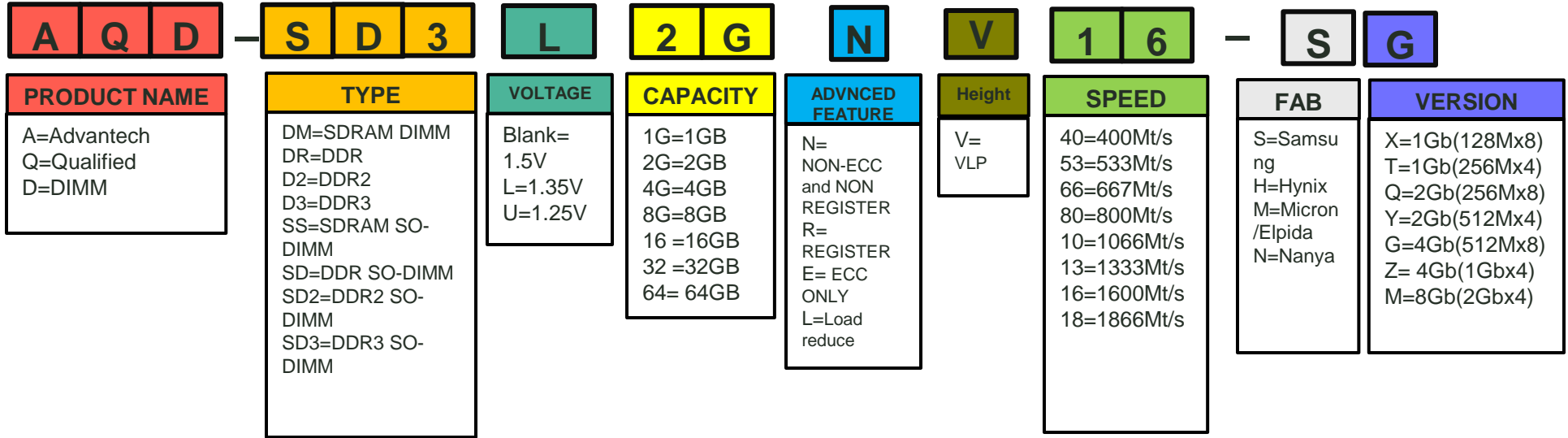

Color / Symbol Key

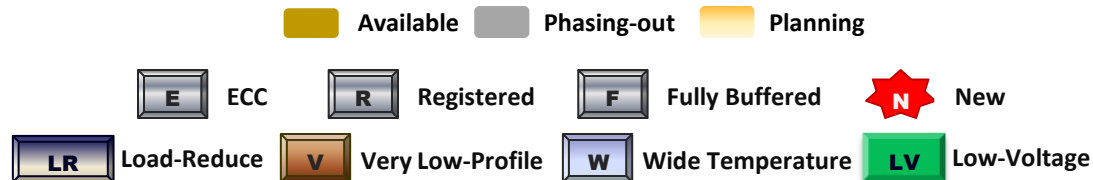

AQD DDR3 Memory Modules Portfolio

| DDR3 1.35 Low Voltage | | 1333 | | 1600 | |
|--------------------------|--------------|--------------------------|---------------------------|------------------|------------------|
| | | LONG | SHORT | LONG | SHORT |
| U-DIMM | 1GB (128X8) | AQD-D31GN13-SX (1.5V) | AQD-SD31GN13-SX (1.5V) | | |
| | 2GB (256MX8) | | | AQD-D3L2GN16-SQ | AQD-SD3L2GN16-SQ |
| | 4GB (512MX8) | | | AQD-D3L4GN16-SG | AQD-SD3L4GN16-SG |
| | 8GB (512MX8) | | | AQD-D3L8GN16-SG | AQD-SD3L8GN16-SG |
| ECC U-DIMM | 4GB (512MX8) | | | AQD-D3L4GE16-SG | |
| | 8GB (512MX8) | | | AQD-D3L8GE16-SG | |
| R-DIMM | 4GB (512MX8) | | | | |
| | 8GB (512MX8) | | | AQD-D3L8GRV16-SG | |
| | 16GB(2Gbx4) | | | AQD-D3L16RV16-SM | |
| LOAD REDUCE | 32GB (2GbX4) | AQD-D3L32L13-SM | | | |

DDR3 DIMM

E ECC
 R Registered
 F Fully Buffered
 N New
LR Load-Reduce
 V Very Low-Profile
 W Wide Temperature
 LV Low-Voltage

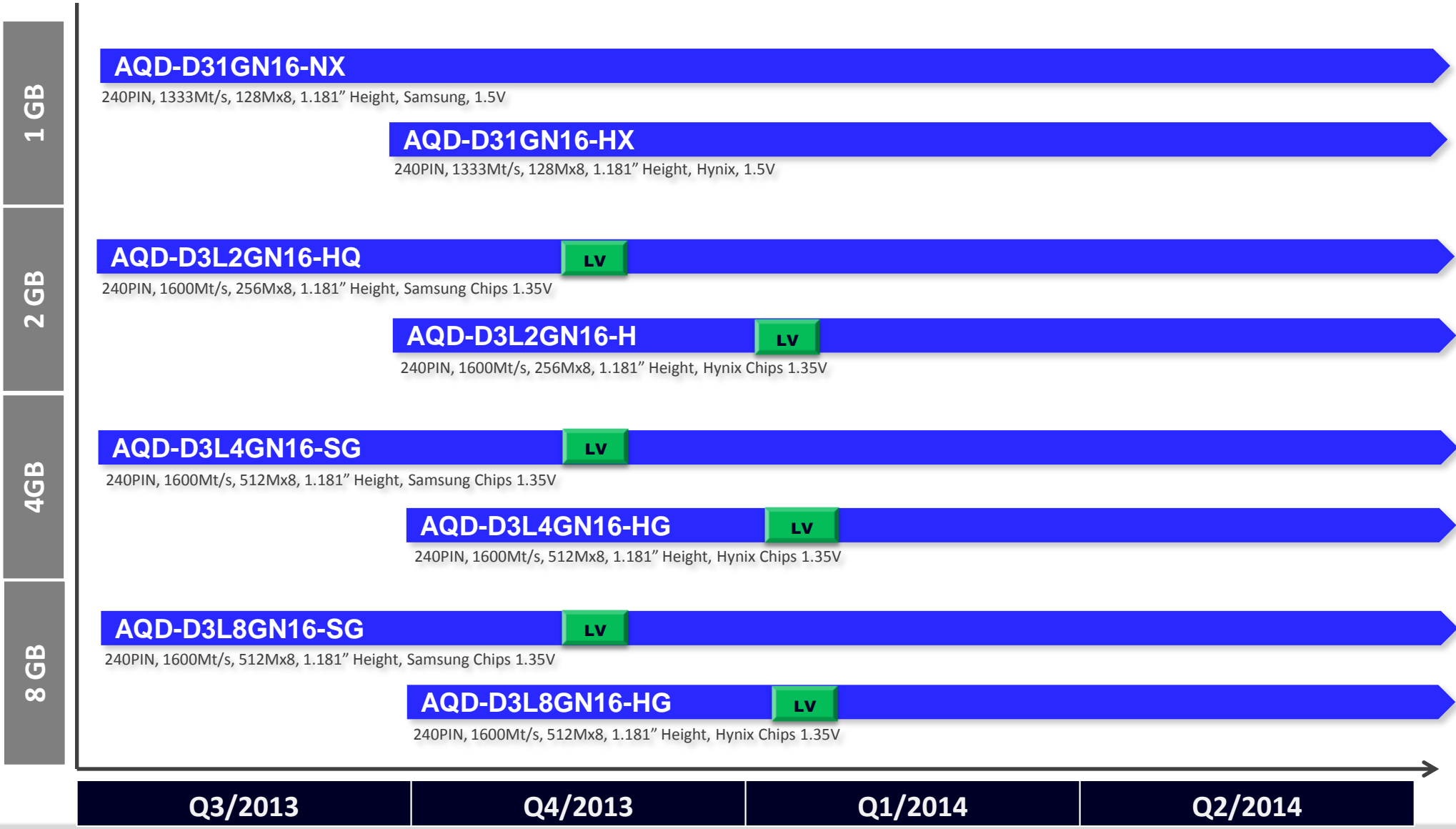

Q3/2013

Q4/2013

Q1/2014

Q2/2014

DDR3 SO-DIMM

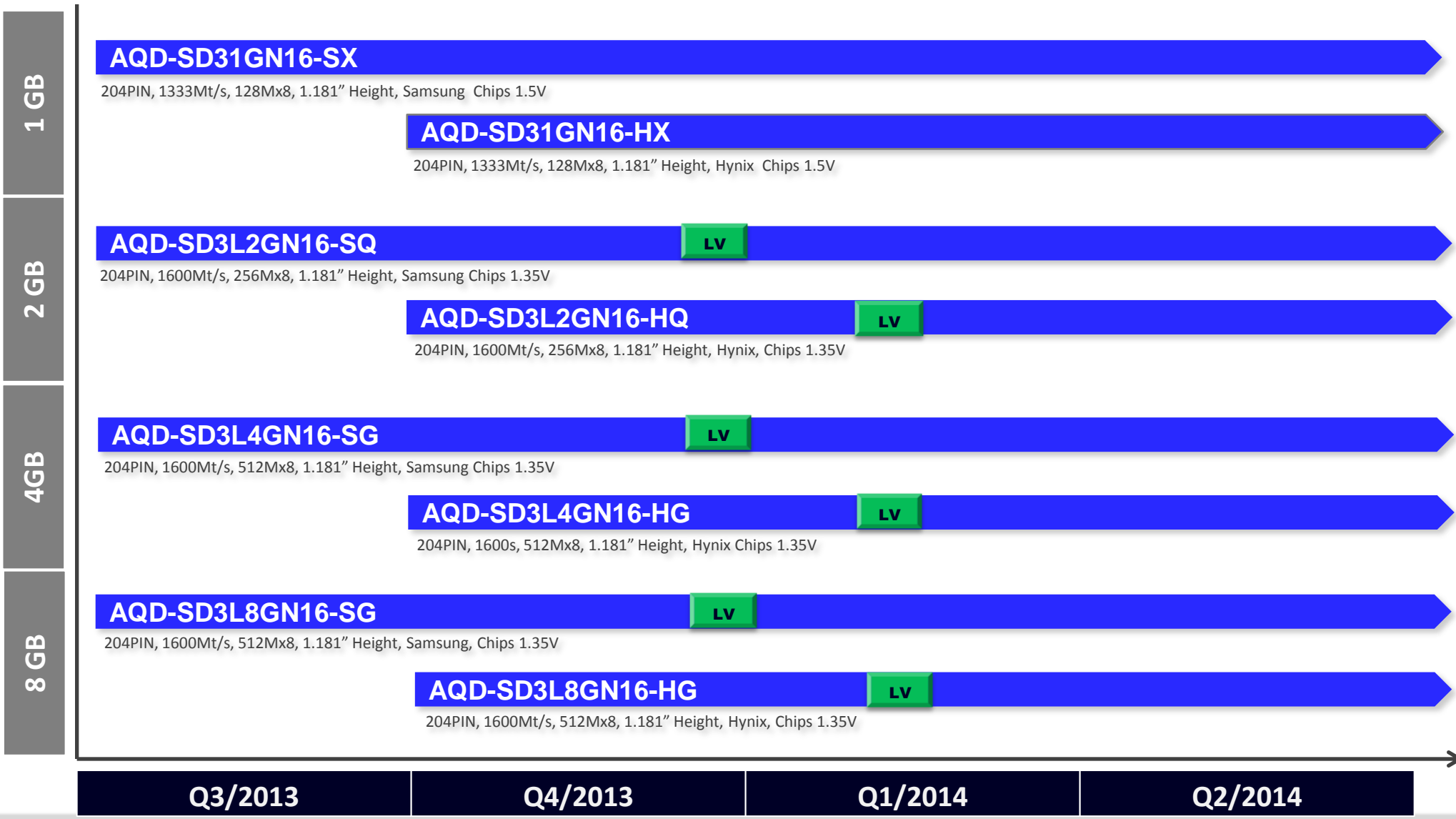

Q3/2013

Q4/2013

Q1/2014

Q2/2014

DDR3 DIMM Advance Feature

ECC

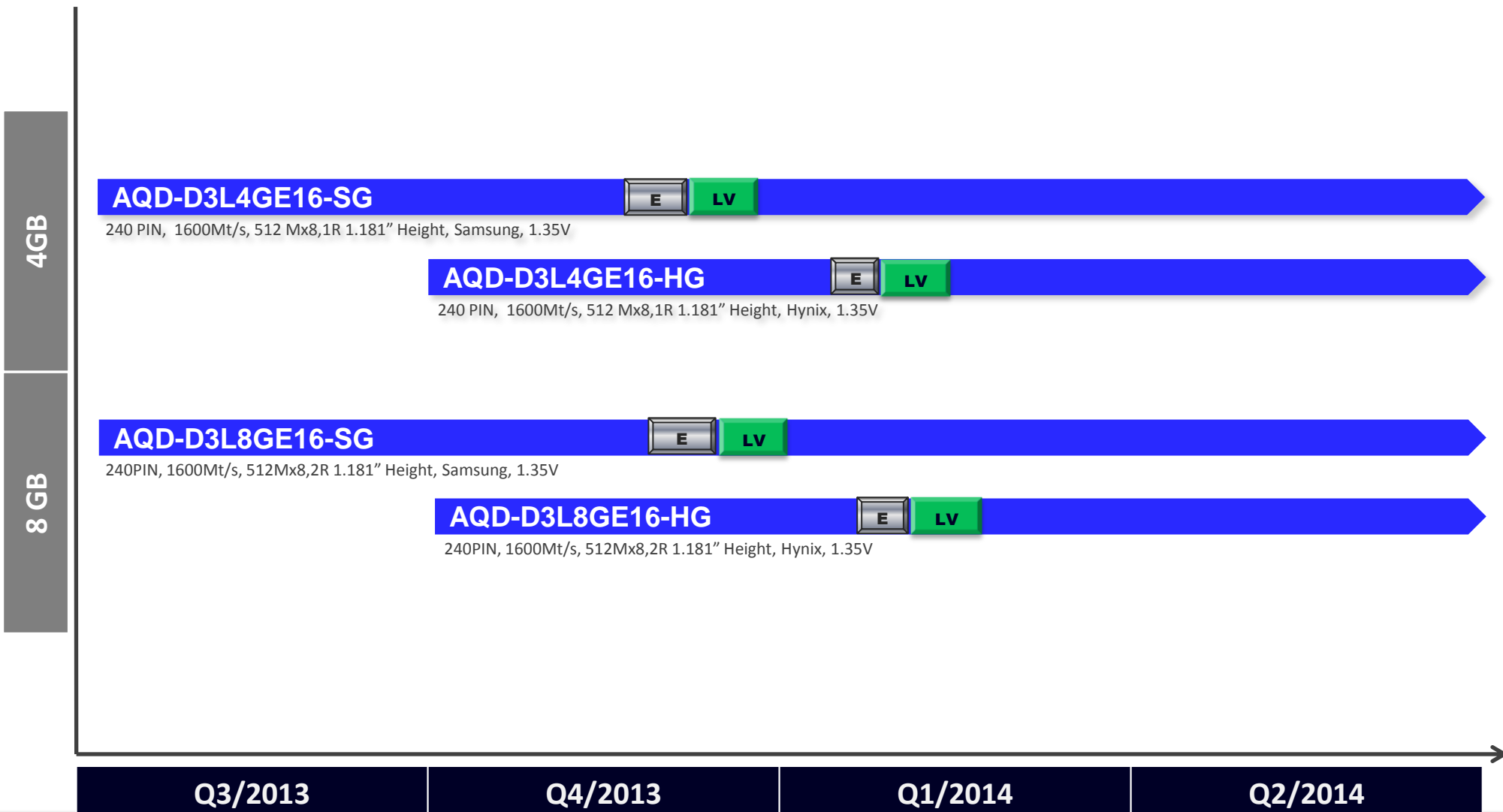

DDR3 SO DIMM Advance Feature

ECC

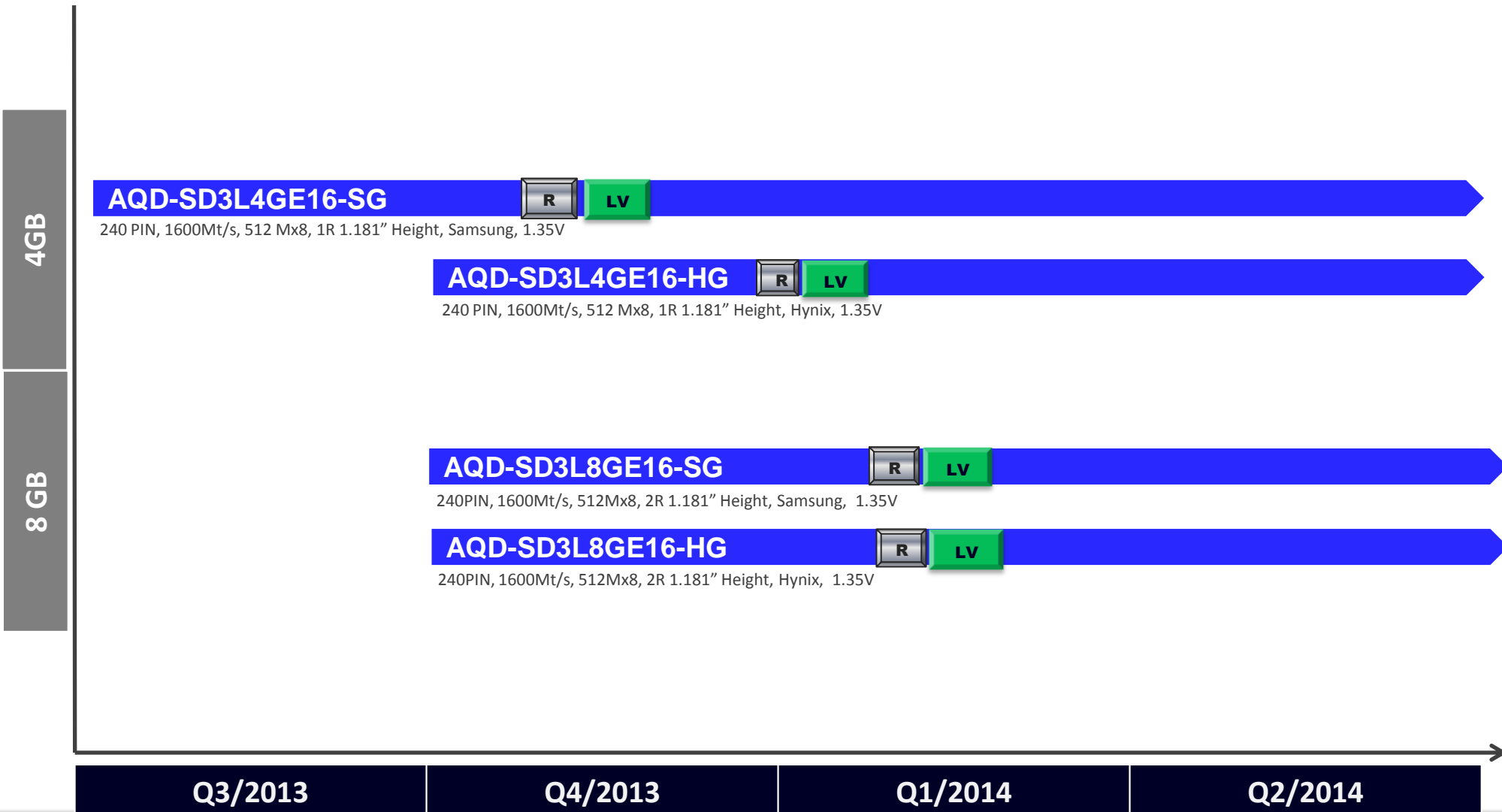

DDR3 DIMM Advance Feature

ECC and Registered

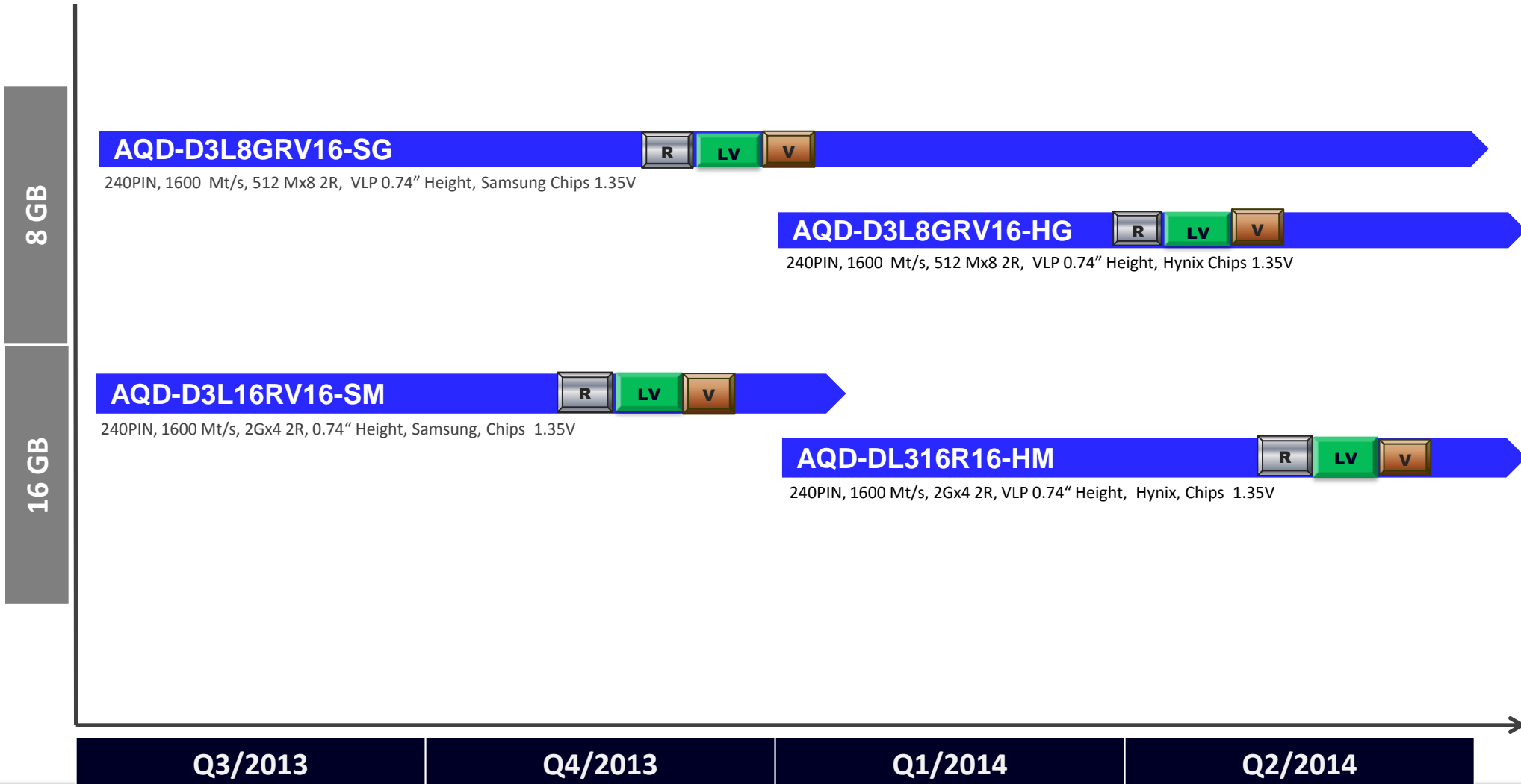

■ Available
 ■ Phasing-out
 ■ Planning

E ECC
 R Registered
 F Fully Buffered
 N New

LR Load-Reduce
 V Very Low-Profile
 W Wide Temperature
 LV Low-Voltage

DDR3 DIMM Advance Feature

Load Reduce

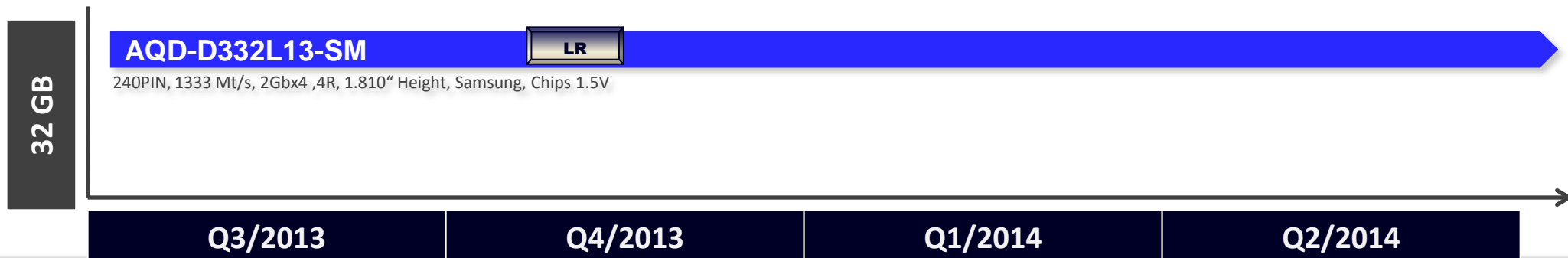

PART II, 96 PARTS MEMORY MODULE

Part Number Decoder

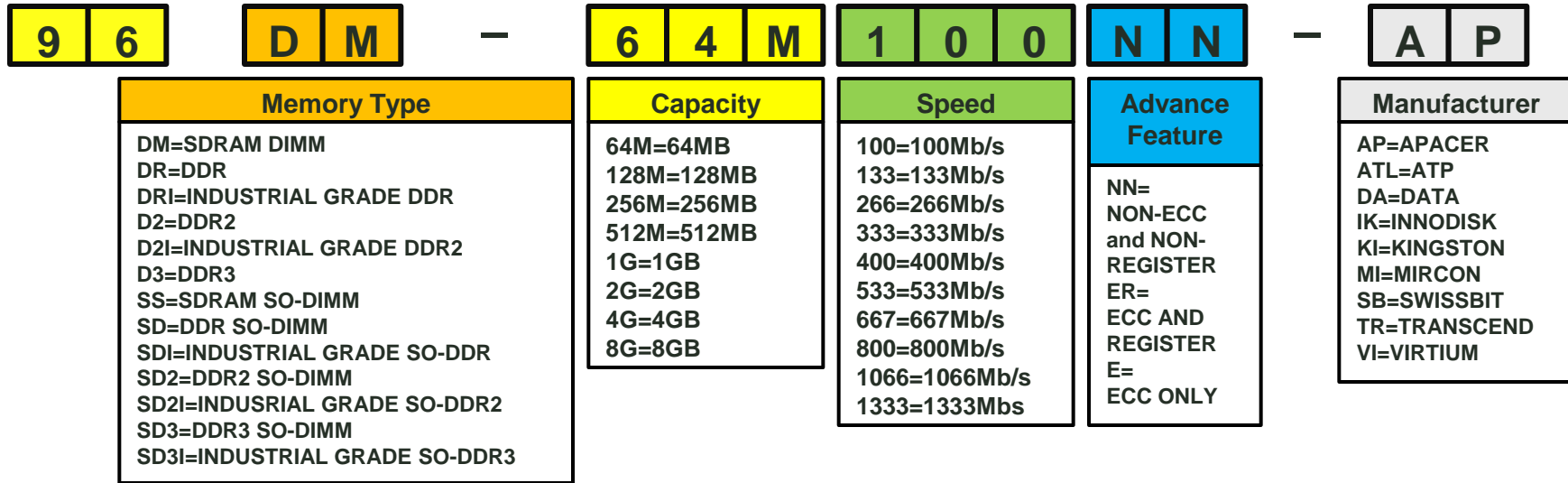

Color / Symbol Key



SDRAM DIMM

Available Phasing-out Planning

E ECC
 R Registered
 F Fully Buffered
 N New
L Low-Profile
 V Very Low-Profile
 W Wide Temperature

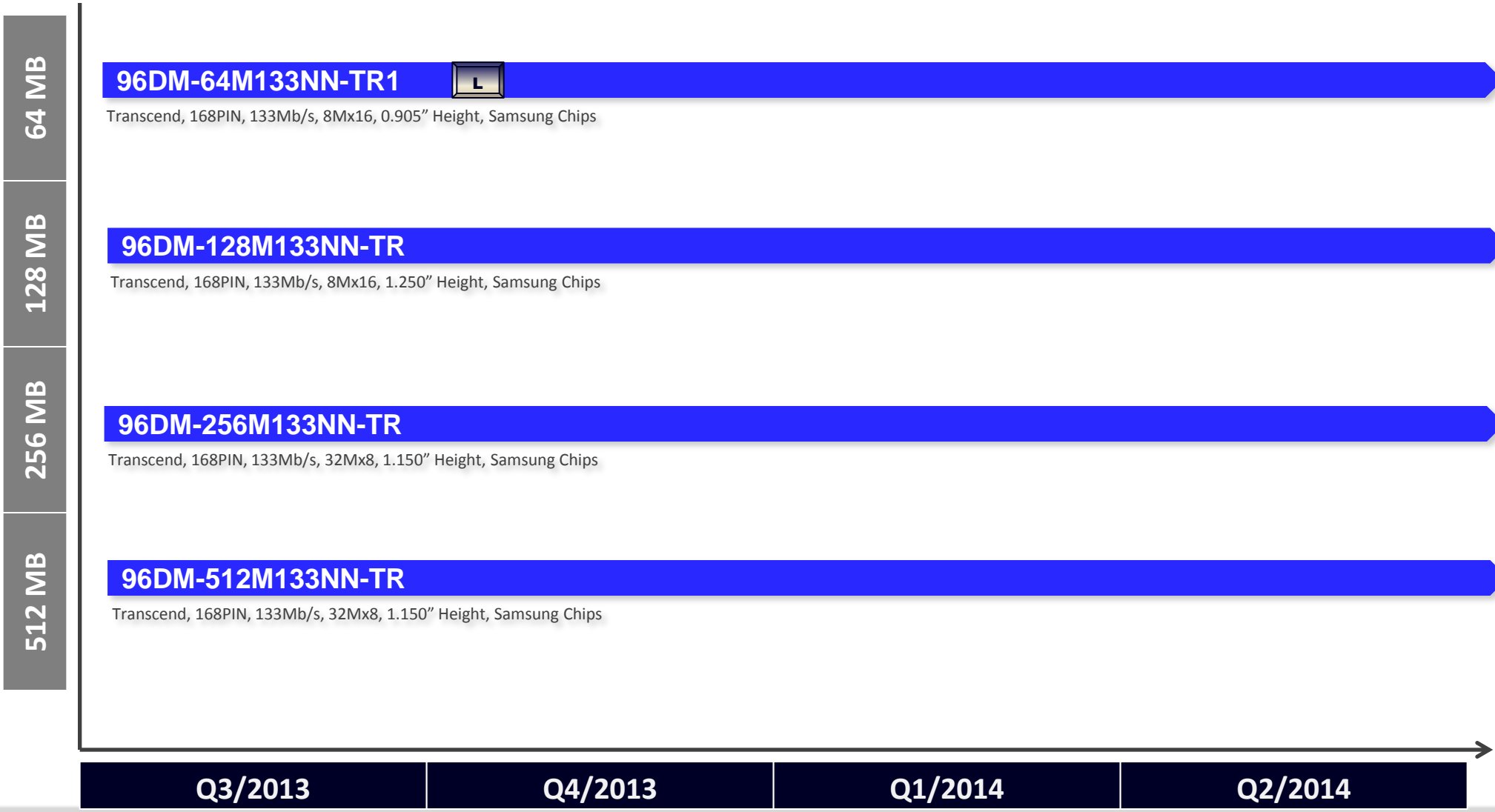

SDRAM SO-DIMM

Available Phasing-out Planning

E ECC
 R Registered
 F Fully Buffered
 N New
L Low-Profile
 V Very Low-Profile
 W Wide Temperature

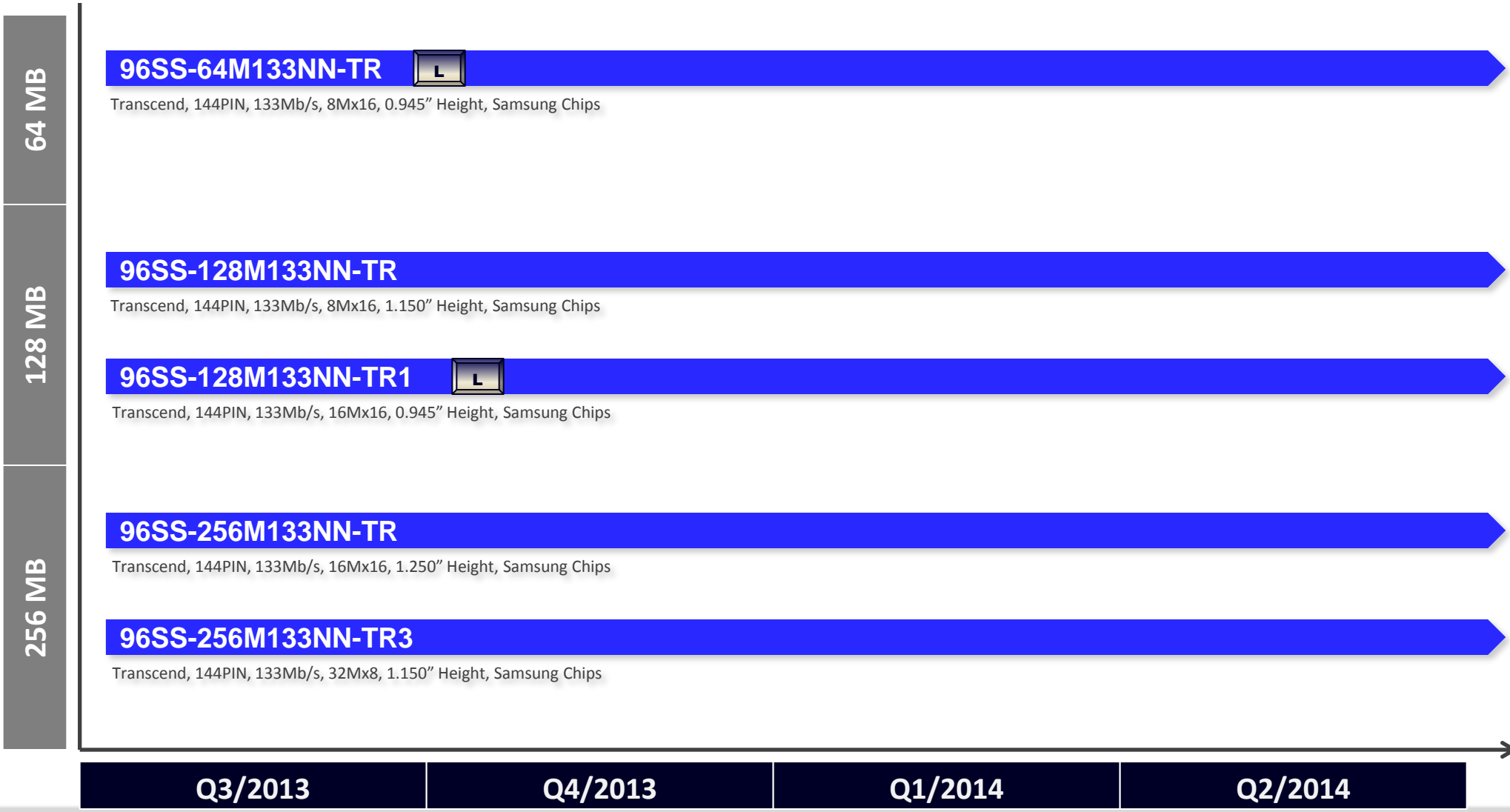

DDR DIMM

Available Phasing-out Planning

E ECC
 R Registered
 F Fully Buffered
 N New
L Low-Profile
 V Very Low-Profile
 W Wide Temperature

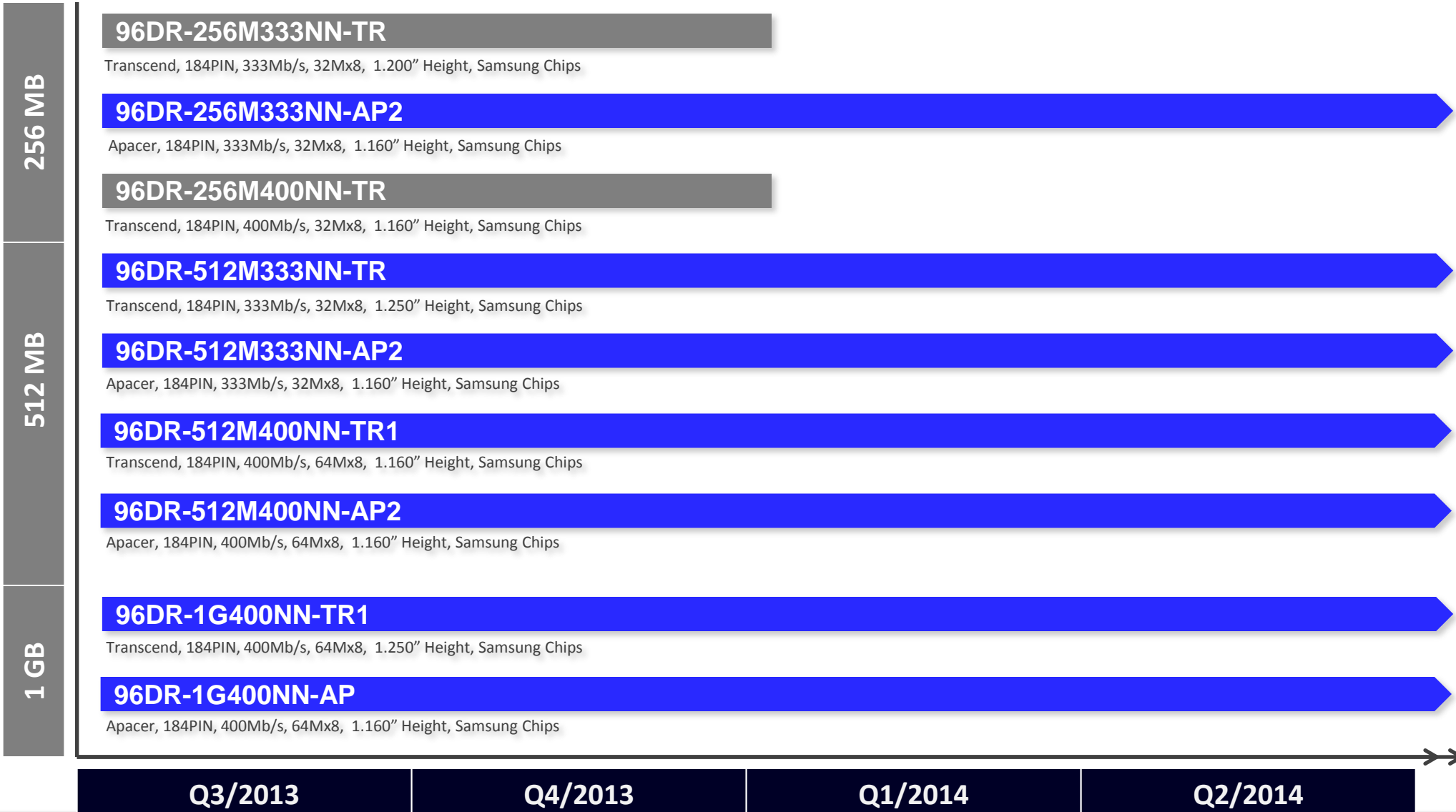

DDR DIMM Advance Feature

Available Phasing-out Planning

E ECC **R** Registered **F** Fully Buffered **N** New
L Low-Profile **V** Very Low-Profile **W** Wide Temperature

ECC

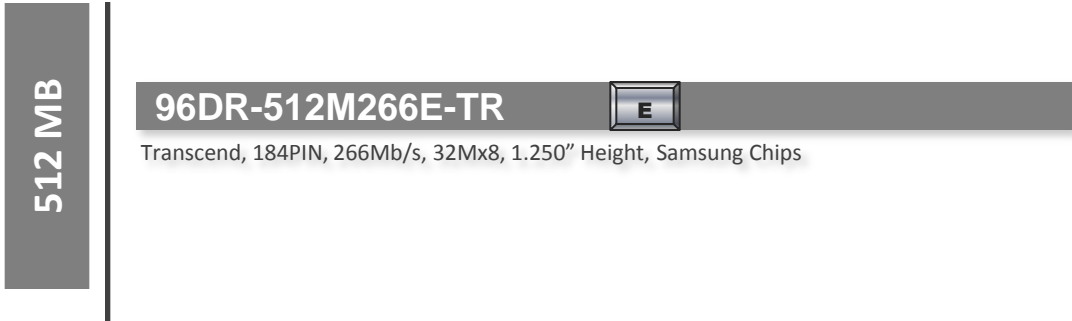

ECC and Registered

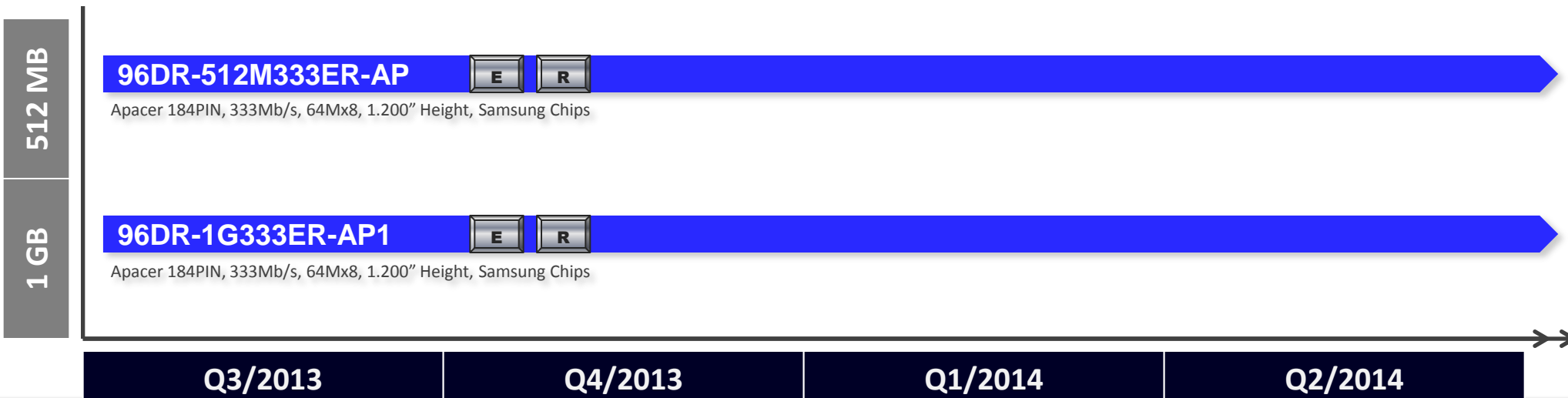

DDR SO-DIMM

Available Phasing-out Planning

E ECC
 R Registered
 F Fully Buffered
 N New
L Low-Profile
 V Very Low-Profile
 W Wide Temperature

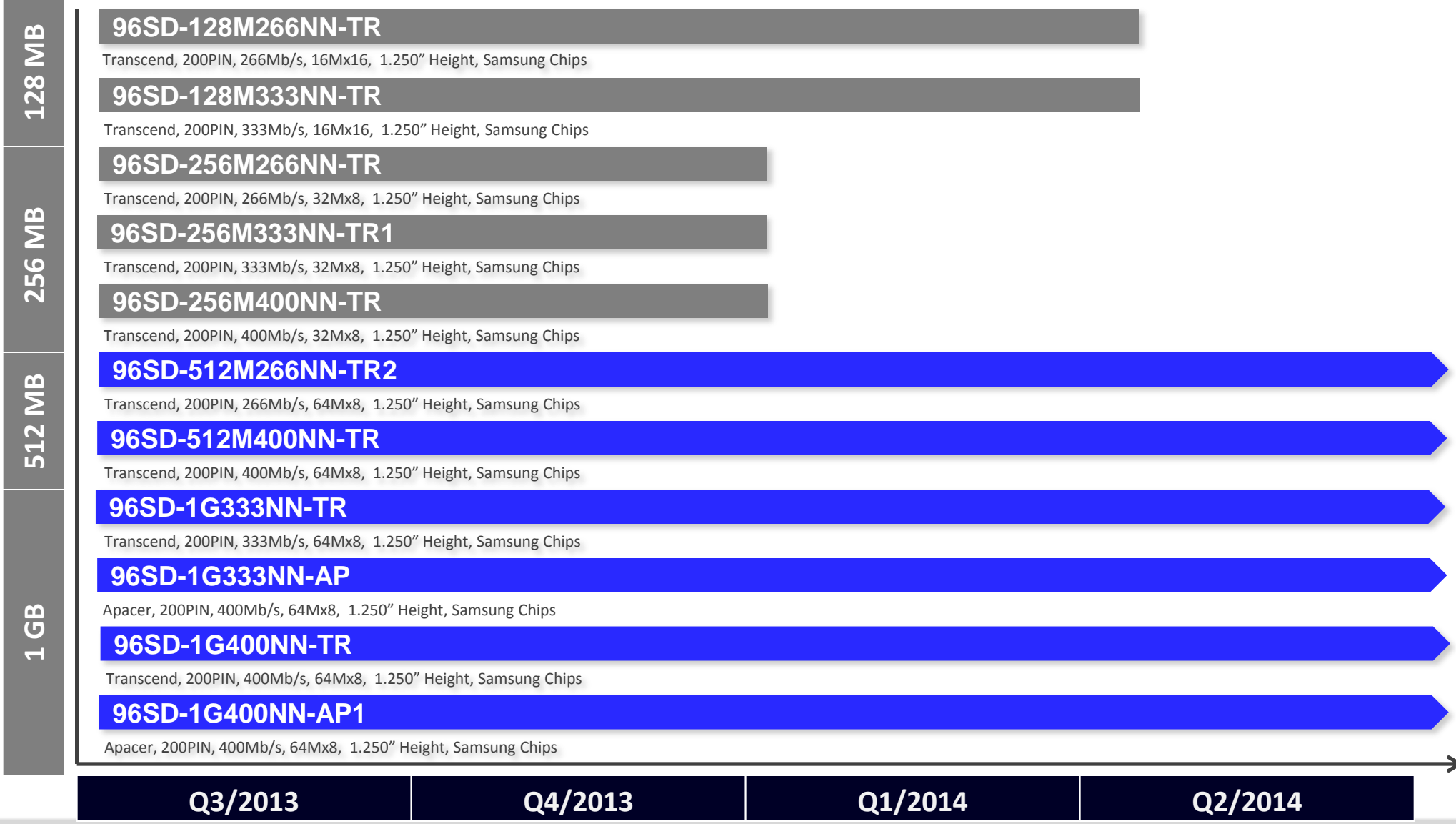

DDR2 DIMM

Available Phasing-out Planning

ECC
 Registered
 Fully Buffered
 New
 Low-Profile
 Very Low-Profile
 Wide Temperature

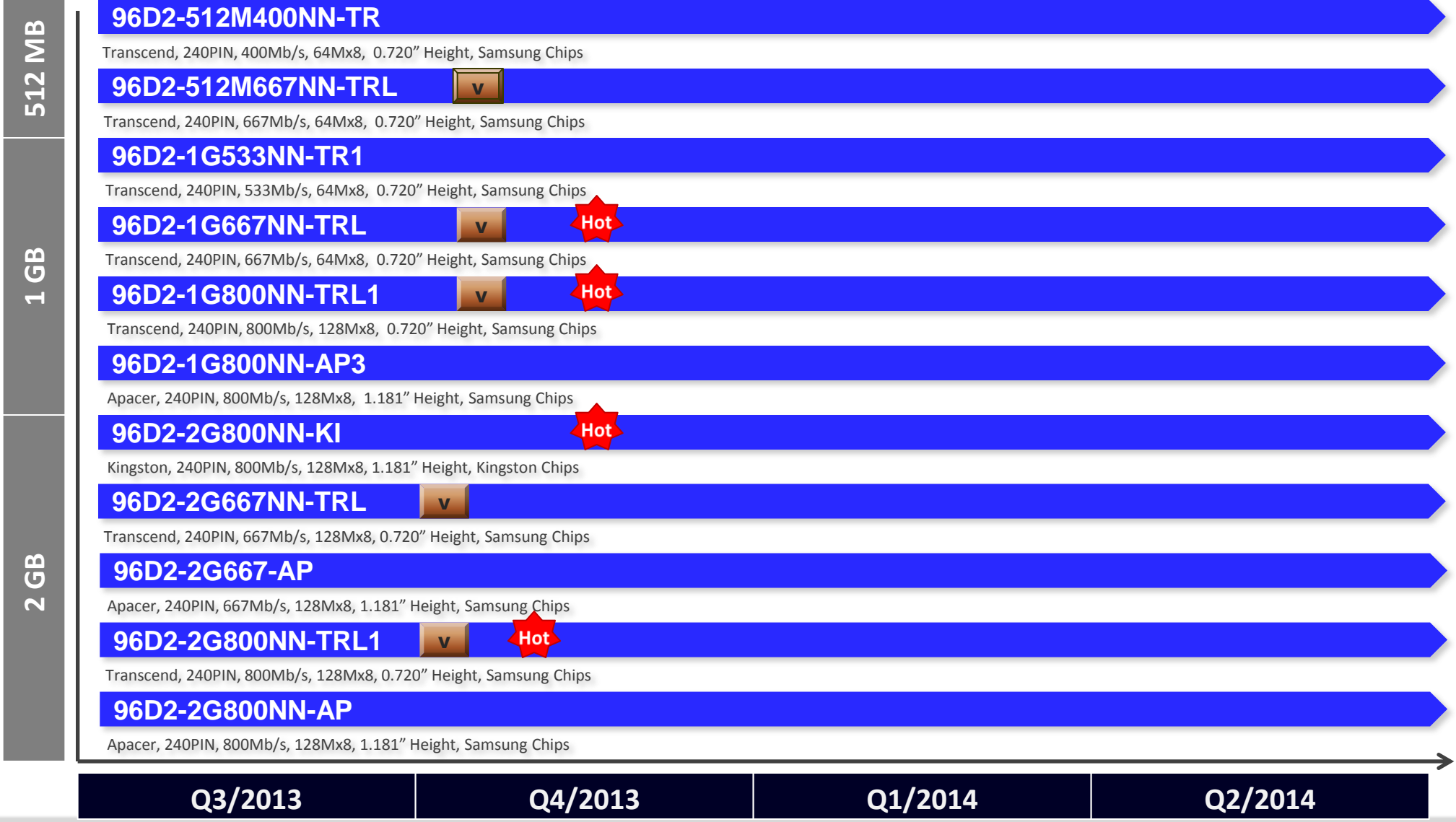

Q3/2013

Q4/2013

Q1/2014

Q2/2014

DDR2 DIMM Advance Feature

Available Phasing-out Planning

E ECC
 R Registered
 F Fully Buffered
 N New
L Low-Profile
 V Very Low-Profile
 W Wide Temperature

ECC



ECC and Registered



Q3/2013

Q4/2013

Q1/2014

Q2/2014

DDR2 DIMM Advance Feature

Available Phasing-out Planning

E ECC **R** Registered **F** Fully Buffered **N** New

L Low-Profile **V** Very Low-Profile **W** Wide Temperature

Fully Buffered

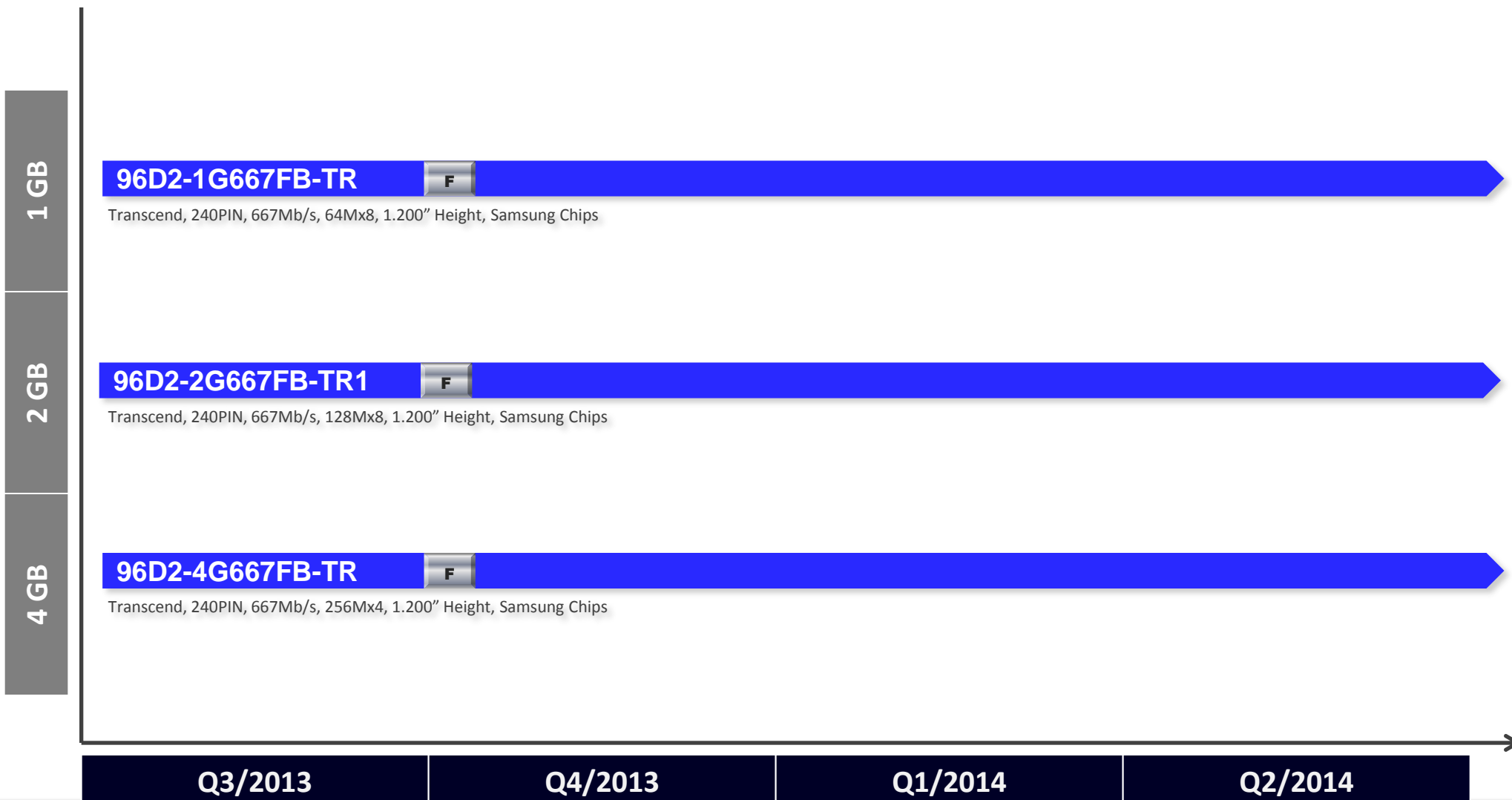

DDR2 SO-DIMM

Available Phasing-out Planning

ECC
 Registered
 Fully Buffered
 New
 Low-Profile
 Very Low-Profile
 Wide Temperature

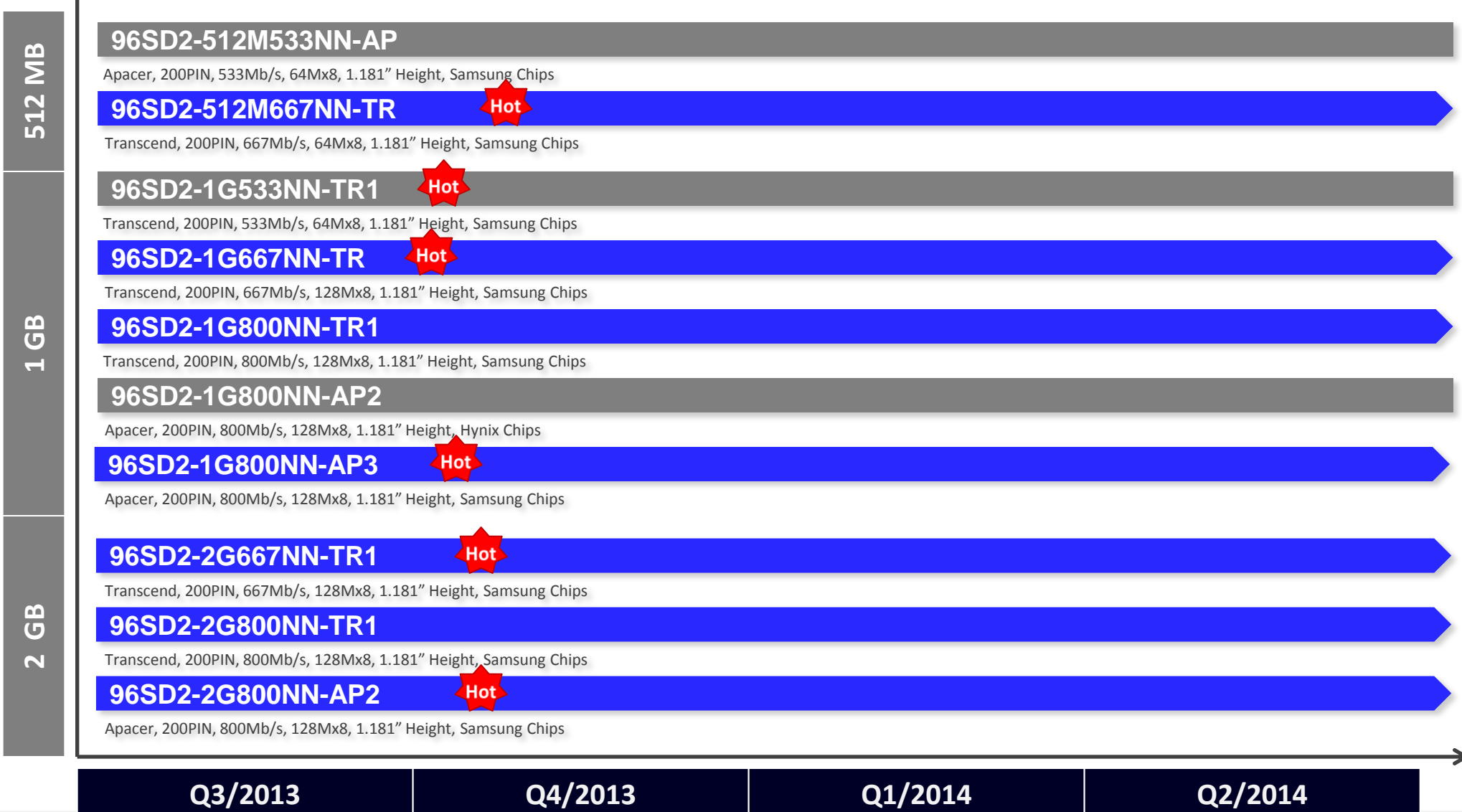

Q3/2013

Q4/2013

Q1/2014

Q2/2014

DDR2 SO-DIMM Wide Temp.

Available Phasing-out Planning

E ECC **R** Registered **F** Fully Buffered **N** New
L Low-Profile **V** Very Low-Profile **W** Wide Temperature

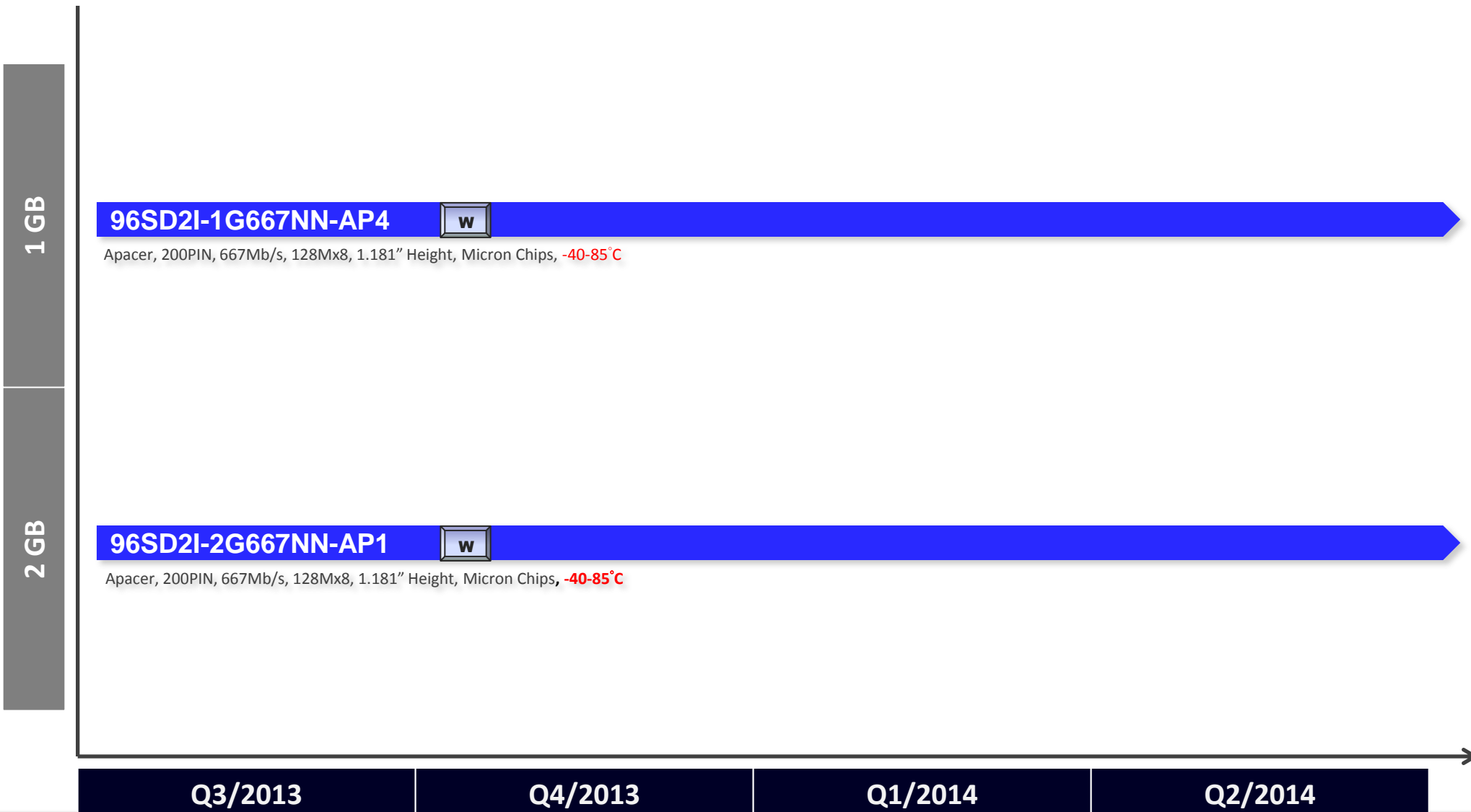

DDR3 DIMM

Available Phasing-out Planning

ECC
 Registered
 Fully Buffered
 New
 Low-Profile
 Very Low-Profile
 Wide Temperature

1 GB

96D3-1G1333NN-TR1

Transcend, 240PIN, 1333Mb/s, 128Mx8, 1.181" Height, Samsung Chips

96D3-1G1333NN-AP1

Apacer, 240PIN, 1333Mb/s, 128Mx8, 1.181" Height, Hynix Chips

96D3-2G1066NN-TR

Transcend, 240PIN, 1066Mb/s, 128Mx8, 1.181" Height, Samsung Chips **EOL:7/9/13**

96D3-2G1333NN-TR2

Transcend, 240PIN, 1333Mb/s, 128Mx8, 1.181" Height, Samsung Chips

96D3-2G1333NN-AP4

Apacer, 240PIN, 1333Mb/s, 128Mx8, 1.181" Height, Hynix Chips

96D3-2G1333NN-TR1

Transcend, 240PIN, 1333Mb/s, 256Mx8, 1.181" Height, Hynix Chips

96D3-2G1333NN-AP1

Apacer, 240PIN, 1333Mb/s, 256Mx8, 1.181" Height, Hynix Chips

96D3-2G1600NN-APL

Apacer, 240PIN, 1600Mb/s, 256Mx8, 0.740" Height, Hynix Chips

96D3-2G1600NN-TR

Transcend, 240PIN, 1600Mb/s, 256Mx8, 1.181" Height, MICRON Chips

96D3-2G1600NN-TRL

Transcend, 240PIN, 1600Mb/s, 256Mx8, 0.74" Height, Samsung Chips

2 GB

Q3/2013

Q4/2013

Q1/2014

Q2/2014

DDR3 DIMM

Available Phasing-out Planning

ECC
 Registered
 Fully Buffered
 New
 Low-Profile
 Very Low-Profile
 Wide Temperature

4 GB

96D3-4G1333NN-TR

Transcend, 240PIN, 1333Mb/s, 256Mx8, 1.181" Height, Hynix Chips

96D3-4G1333NN-AP

Apacer, 240PIN, 1333Mb/s, 256Mx8, 1.181" Height, Hynix Chips

96D3-4G1600NN-APL

Apacer, 240PIN, 1600Mb/s, 256Mx8, 0.740" Height, Hynix Chips

96D3-4G1600NN-TR

Transcend, 240PIN, 1600Mb/s, 256Mx8, 1.181" Height, Micron Chips **EOL:7/9/2013**

96D3-4G1600NN-TR

Transcend, 240PIN, 1600Mb/s, 256Mx8, 1.181" Height, Samsung Chips

8 GB

96D3-8G1333NN-APL

Apacer, 240PIN, 1333Mb/s, 512Mx8, 0.740" Height, Micron Chips

96D3-8G1600NN-APL

Apacer, 240PIN, 1600Mb/s, 512Mx8, 0.740" Height, Micron Chips

96D3-8G1600NN-TR

Transcend, 240PIN, 1600Mb/s, 512Mx8, 1.181" Height, Micron Chips

Q3/2013

Q4/2013

Q1/2014

Q2/2014

DDR3 DIMM Advance Feature

Available Phasing-out Planning

E ECC
 R Registered
 F Fully Buffered
 N New
L Low-Profile
 V Very Low-Profile
 W Wide Temperature

ECC

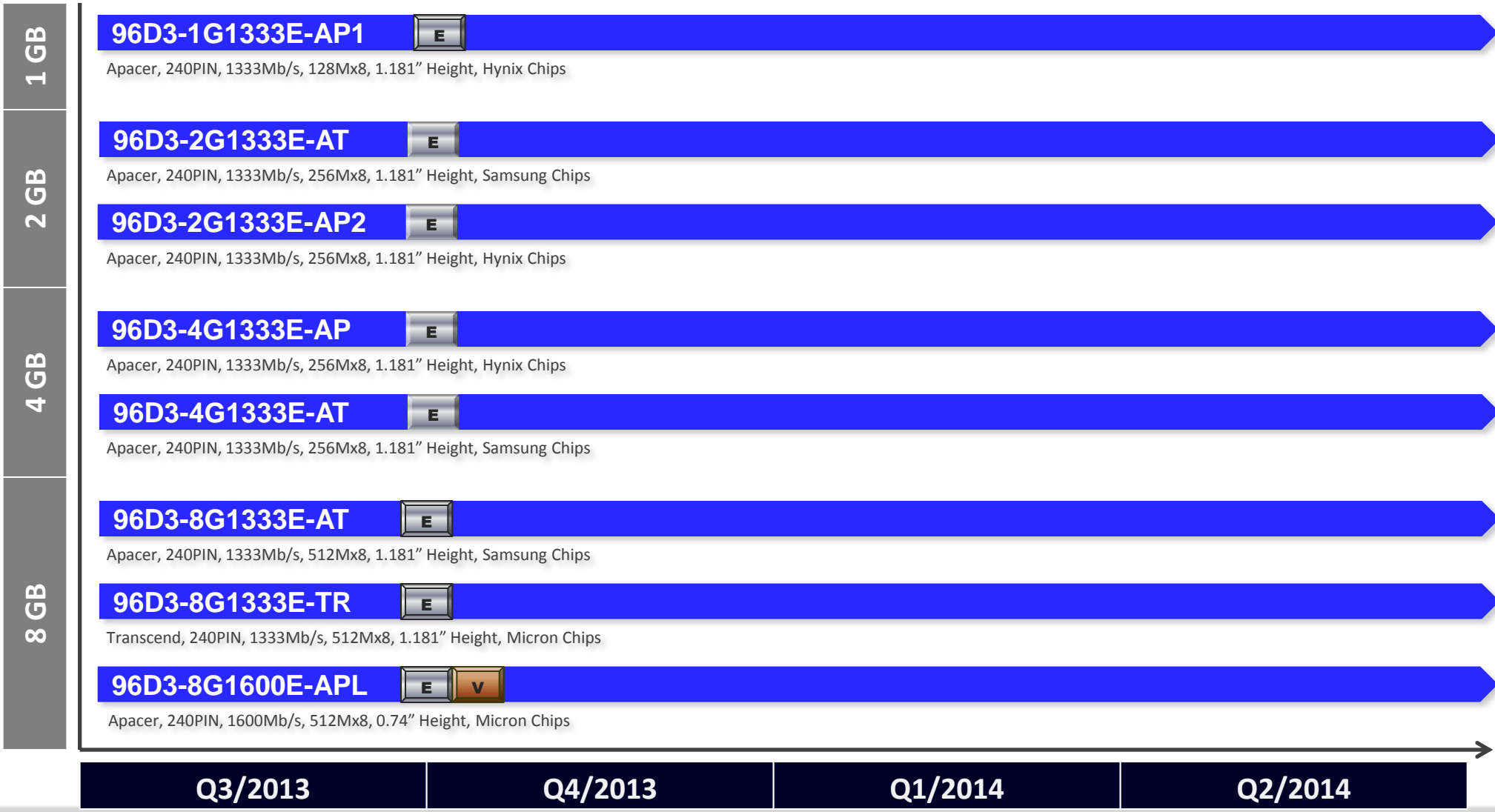

Q3/2013

Q4/2013

Q1/2014

Q2/2014

DDR3 DIMM Advance Feature

Available Phasing-out Planning

E ECC
 R Registered
 F Fully Buffered
 N New
L Low-Profile
 V Very Low-Profile
 W Wide Temperature

ECC and Registered

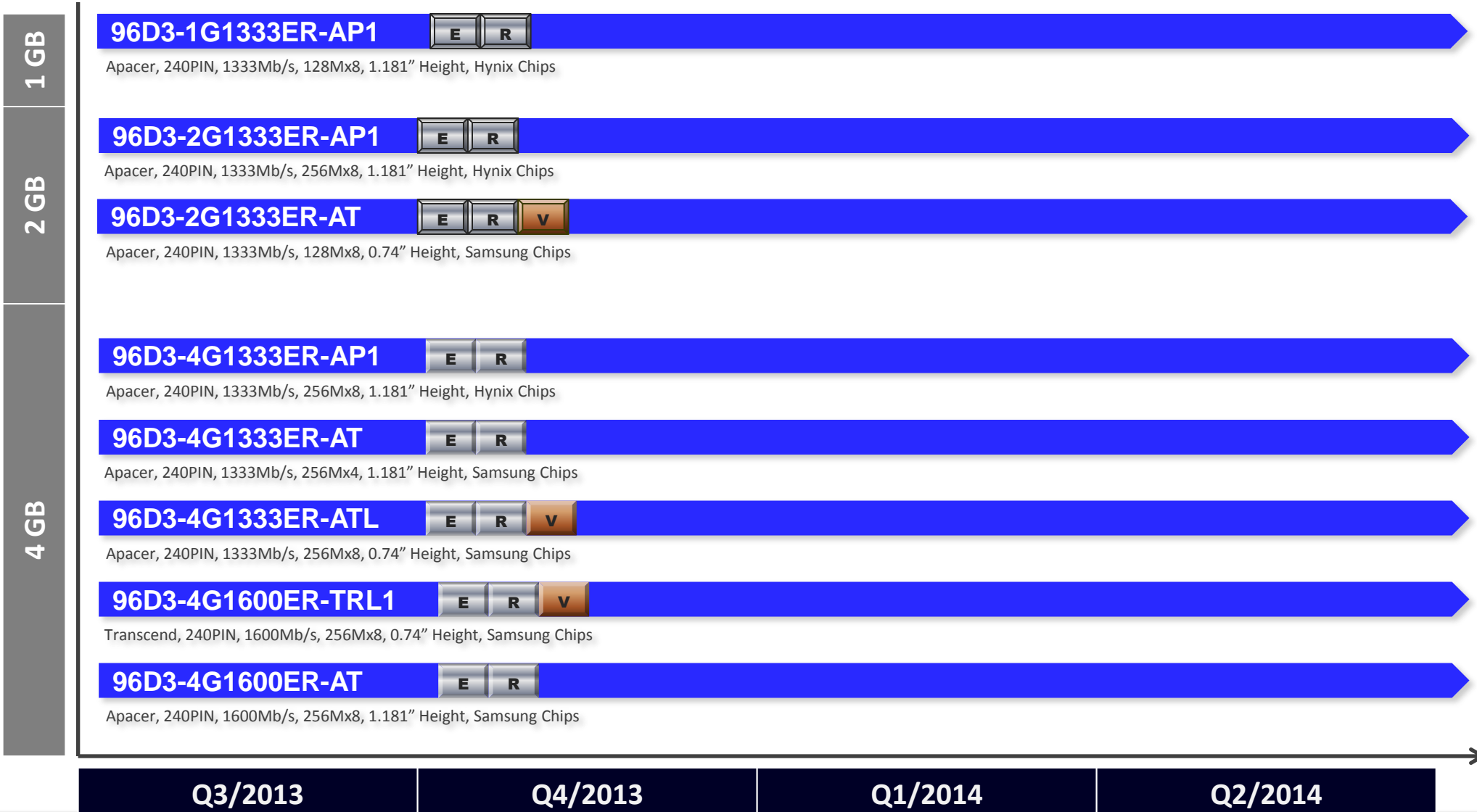

DDR3 DIMM Advance Feature

Available Phasing-out Planning

E ECC **R** Registered **F** Fully Buffered **N** New
L Low-Profile **V** Very Low-Profile **W** Wide Temperature

ECC and Registered

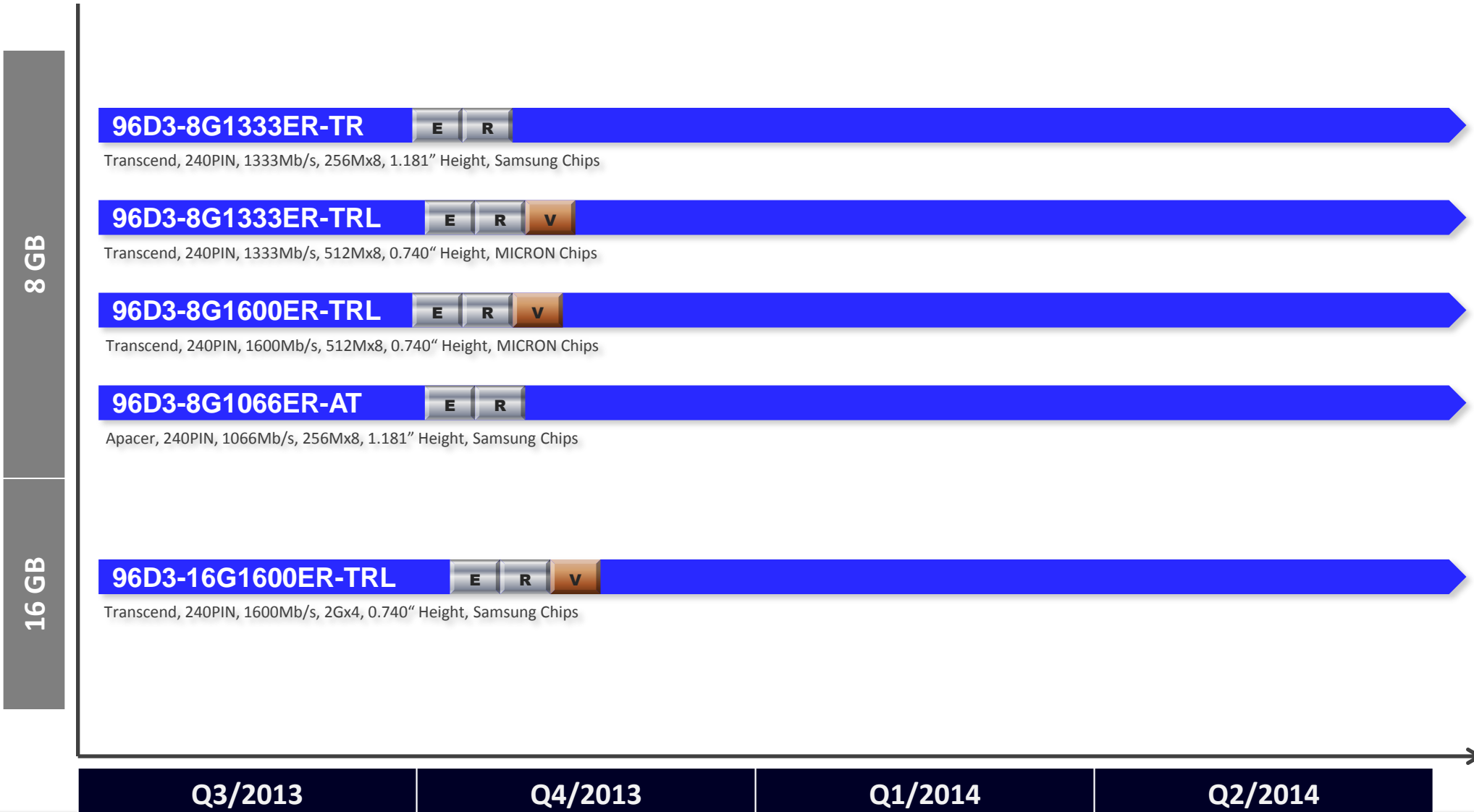

DDR3 SO-DIMM

Available Phasing-out Planning

E ECC R Registered F Fully Buffered N New
L Low-Profile V Very Low-Profile W Wide Temperature

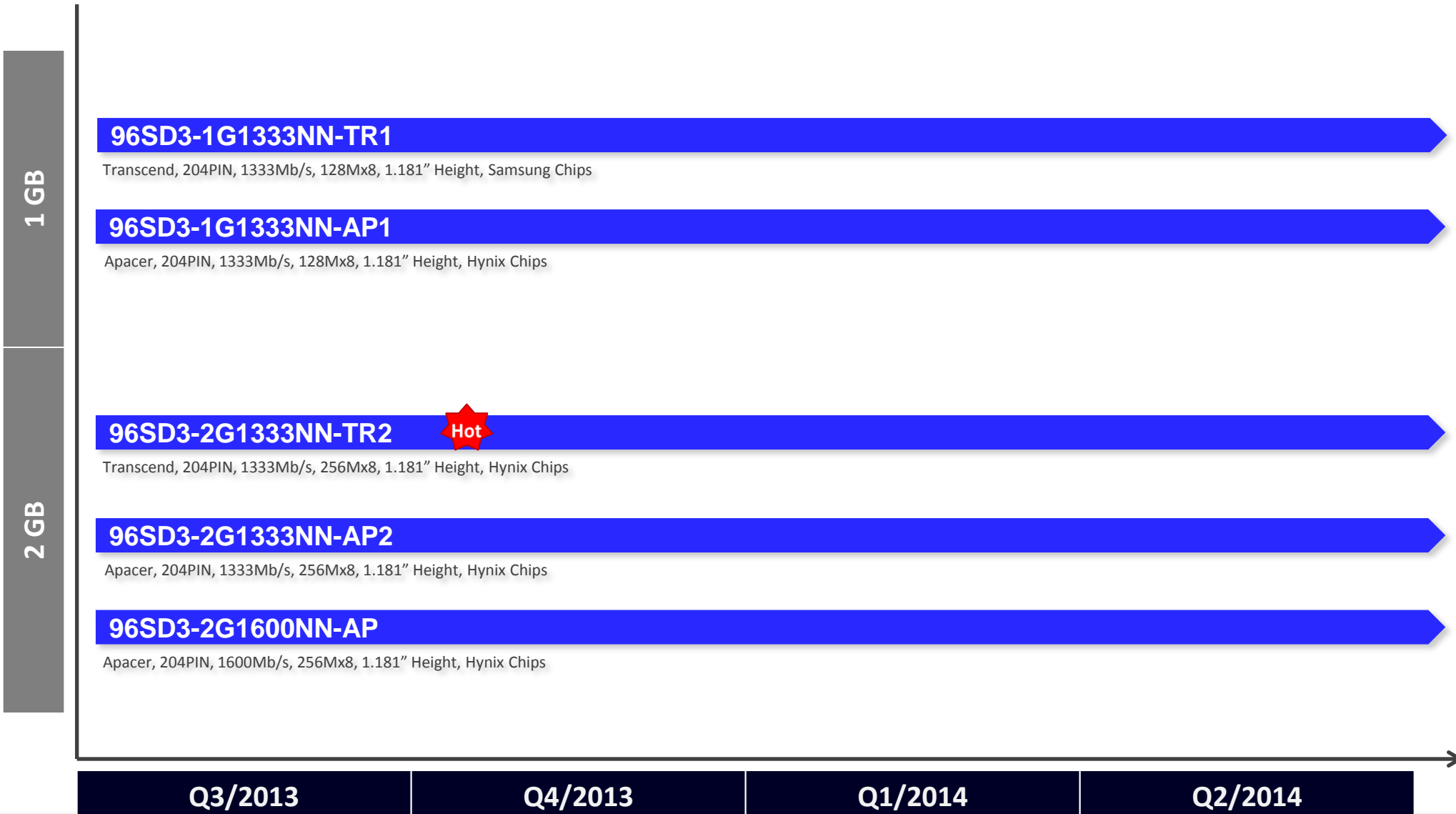

Q3/2013

Q4/2013

Q1/2014

Q2/2014

DDR3 SO-DIMM

Available Phasing-out Planning

E ECC
 R Registered
 F Fully Buffered
 N New
L Low-Profile
 V Very Low-Profile
 W Wide Temperature

4 GB

96SD3-4G1066NN-AP

Apacer, 204PIN, 1066Mb/s, 256Mx8, 1.181" Height, Hynix Chips

96SD3-4G1333NN-TR1

Transcend, 204PIN, 1333Mb/s, 256Mx8, 1.181" Height, Hynix Chips

96SD3-4G1333NN-AP1

Apacer, 204PIN, 1333Mb/s, 256Mx8, 1.181" Height, Hynix Chips

96SD3-4G1600NN-TR

Transcend, 204PIN, 1600Mb/s, 256Mx8, 1.181" Height, Micron Chips

96SD3-4G1600NN-AP

Apacer, 204PIN, 1600Mb/s, 256Mx8, 1.181" Height, Hynix Chips

8 GB

96SD3-8G1333NN-TR

Transcend, 204PIN, 1333Mb/s, 512Mx8, 1.181" Height, Micron Chips

96SD3-8G1600NN-TR

Transcend, 204PIN, 1600Mb/s, 512Mx8, 1.181" Height, Micron Chips

96SD3-8G1600NN-AP

Apacer, 204PIN, 1600Mb/s, 512Mx8, 1.181" Height, HYNIX Chips

96SD3-8G1600NN-AT

Apacer, 204PIN, 1600Mb/s, 512Mx8, 1.181" Height, Samsung Chips

Q3/2013

Q4/2013

Q1/2014

Q2/2014

DDR3 SO-DIMM

Advance Feature - ECC

Available Phasing-out Planning

E ECC **R** Registered **F** Fully Buffered **N** New
L Low-Profile **V** Very Low-Profile **W** Wide Temperature

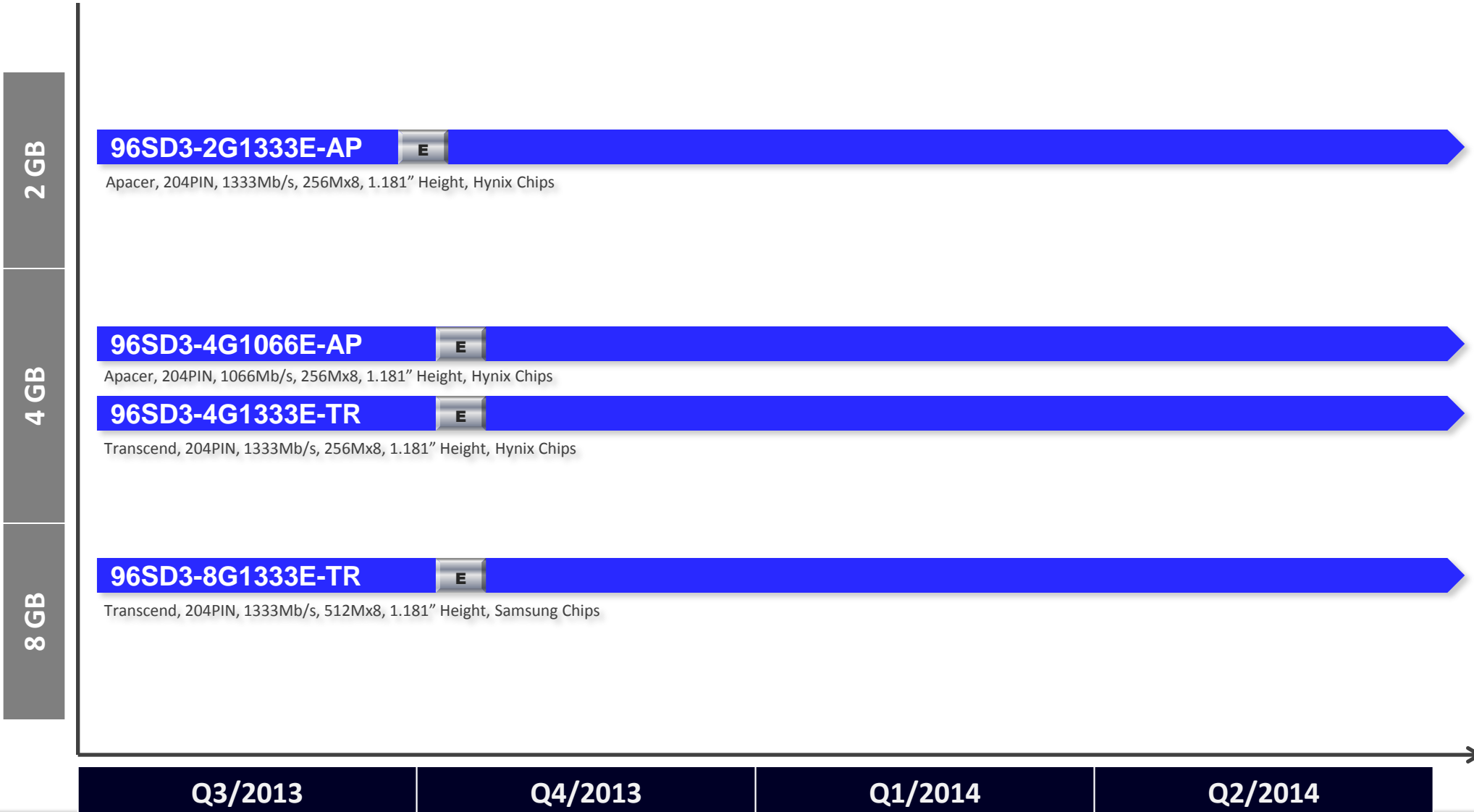

DDR3 SO-DIMM

Low Voltage.

Available Phasing-out Planning

E ECC **R** Registered **F** Fully Buffered **N** New
L Low-Profile **V** Very Low-Profile **W** Wide Temperature

2 GB

96SD3L-2G1600NN-TR

Transcend, 204PIN, 1600Mb/s, 256Mx8, 1.35V, 1.181" Height, Samsung Chips **EOL:7/9/2013**

4 GB

96SD3L-4G1333NN-AP

Apacer, 204PIN, 1333Mb/s, 512Mx8, 1.35V, 1.181" Height, MICRO Chips

96SD3L-4G1600NN-TR

Transcend, 204PIN, 1600Mb/s, 512Mx8, 1.35V, 1.181" Height, SAMSUNG Chips **EOL:7/9/2013**

8 GB

96SD3L-8G1333NN-AP

Apacer, 204PIN, 1333Mb/s, 512Mx8, 1.35V, 1.181" Height, MICRO Chips

96SD3L-8G1600NN-TR

Transcend, 204PIN, 1600Mb/s, 512Mx8, 1.35V, 1.181" Height, SAMSUNG Chips **EOL:7/9/2013**

Q3/2013

Q4/2013

Q1/2014

Q2/2014

Memory EOL Procedure

- For support and product management optimization, PAPS will follow the Memory phase-out procedure as below.



Thank you

