

TO-92S



Pin Definition:

1. V_{CC}
2. GND
3. Output

TSOT-23



Pin Definition:

1. V_{CC}
2. Output
3. GND

Description

TSH251 Hall-effect sensor is a temperature stable, stress-resistant, Low Tolerance of Sensitivity micro-power switch. Superior high-temperature performance is made possible through a dynamic offset cancellation that utilizes chopper-stabilization. This method reduces the offset voltage normally caused by device over molding, temperature dependencies, and thermal stress. TSH251 is special made for low operation voltage at 1.65V, to active the chip which includes the following on a single silicon chip: voltage regulator, Hall voltage generator, small-signal amplifier, chopper stabilization, Schmitt trigger, CMOS output driver. Advanced CMOS wafer fabrication processing is used to take advantage of low-voltage requirements, component matching, very low input-offset errors, This device requires the presence of omni-polar magnetic fields for operation.

Features

- CMOS Hall IC Technology
- Strong RF noise protection
- 1.65 to 3.5V for battery-powered applications
- Omni polar, output switches with absolute value of North or South pole from magnet
- Operation down to 1.65V, micropower consumption
- High Sensitivity for reed switch replacement applications
- Low sensitivity drift in crossing of Temp. range
- Ultra Low power consumption at 5 μ A (avg.)
- High ESD Protection, HBM > \pm 4KV(min)
- Totem-pole output

Ordering Information

Part No.	Package	Packing
TSH251CT B0G	TO-92S	1kpcs / Bulk Bag
TSH251CX RFG	TSOT-23	3kpcs / 7" Reel

Note: "G" denote for Halogen Free Product

Application

- Solid state switch, Water Meter, Floating Meter
- Handheld Wireless Handset Awake Switch (Flip Cell/PHS Phone/Note Book/Flip Video Set)
- Lid close sensor for battery powered devices
- Magnet proximity sensor for reed switch replacement in low duty cycle applications

Absolute Maximum Ratings (T_A=25°C unless otherwise noted)

Characteristics	Limit	Value	Unit	
Supply voltage	V _{DD}	4.5	V	
Output Voltage	V _{OUT}	4.5	V	
Reverse Voltage	V _{DD/OUT}	-0.3	V	
Magnetic flux density		Unlimited	Gauss	
Output current	I _{OUT}	1	mA	
Operating temperature range	T _{OPR}	-40 to +85	°C	
Storage temperature range	T _{STG}	-65 to +150	°C	
Maximum Junction Temp	T _J	150	°C	
Thermal Resistance - Junction to Ambient	TO-92S	R _{θJA}	206	°C/W
	TSOT-23			
Thermal Resistance - Junction to Case	TO-92S	R _{θJC}	148	°C/W
	TSOT-23			
Package Power Dissipation	TO-92S	P _D	606	mW
	TSOT-23			

Note: Exceeding the absolute maximum ratings may cause permanent damage. Exposure to absolute maximum-rated conditions for extended periods may affect device reliability.

Block Diagram

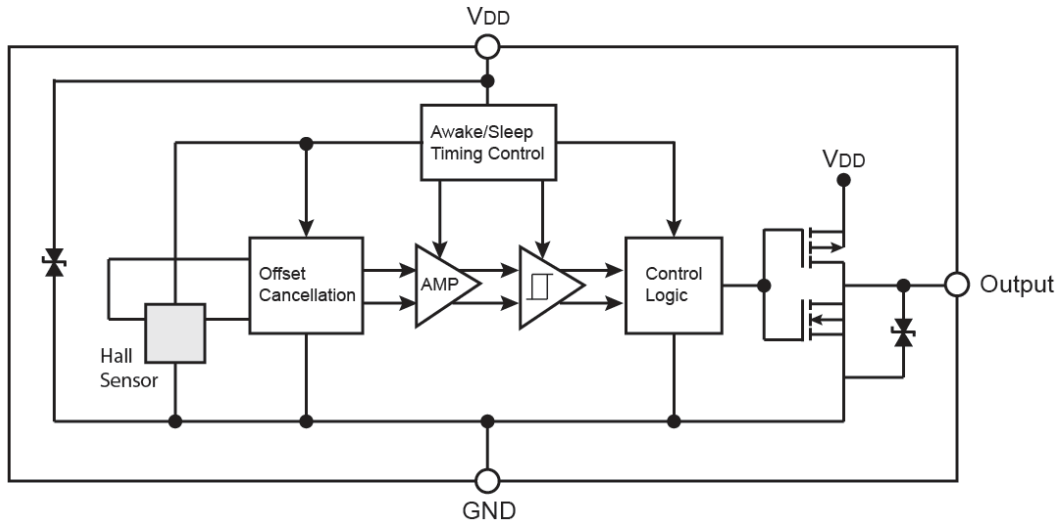

Note: Static sensitive device; please observe ESD precautions. Reverse V_{DD} protection is not included. For reverse voltage protection, a 100Ω resistor in series with V_{DD} is recommended.

Typical Application Circuit

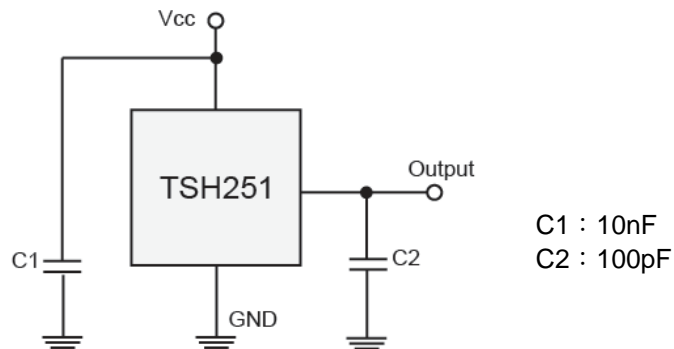

Electrical Specifications (DC Operating Parameters: $T_A=+25^{\circ}C$, $V_{DD}=1.8V$)

Parameters	Test Conditions	Min	Typ	Max	Units
Supply Voltage	Operating	1.65	--	3.5	V
Supply Current	Awake State	--	1.4	3	mA
	Sleep State	--	3.6	7	μA
	Average	--	5	10	μA
Output Leakage Current	Output off	--	--	1	μA
Output High Voltage	$I_{OUT}=0.5mA(\text{Source})$	$V_{DD}-0.2$	--	--	V
Output Low Voltage	$I_{OUT}=0.5mA(\text{Sink})$	--	--	0.2	V
Awake mode time	Operating	--	40	80	us
Sleep mode time	Operating	--	40	80	ms
Duty Cycle		--	0.1	--	%
Electro-Static Discharge	HBM	4	--	--	KV

Magnetic Specifications (TSH251CT)

Parameter	Symbol	Test Conditions	Min.	Typ.	Max.	Units
Operating Point	B _{OPS}	S pole to branded side, B > B _{OP} , V _{OUT} On	--	30	55	Gauss
	B _{OPN}	N pole to branded side, B > B _{OP} , V _{OUT} On	-55	-30	--	Gauss
Release Point	B _{RPS}	S pole to branded side, B < B _{RP} , V _{OUT} Off	10	20	--	Gauss
	B _{RPN}	N pole to branded side, B < B _{RP} , V _{OUT} Off	--	-20	-10	Gauss
Hysteresis	B _{HYS}	B _{OPX} - B _{RPX}	--	10	--	Gauss

Note: 1G (Gauss) = 0.1mT (millitesta)

Magnetic Specifications (TSH251CX)

Parameter	Symbol	Test Conditions	Min.	Typ.	Max.	Units
Operating Point	B _{OPS}	N pole to branded side, B > B _{OP} , V _{OUT} On	--	30	55	Gauss
	B _{OPN}	S pole to branded side, B > B _{OP} , V _{OUT} On	-55	-30	--	Gauss
Release Point	B _{RPS}	N pole to branded side, B < B _{RP} , V _{OUT} Off	10	20	--	Gauss
	B _{RPN}	S pole to branded side, B < B _{RP} , V _{OUT} Off	--	-20	-10	Gauss
Hysteresis	B _{HYS}	B _{OPX} - B _{RPX}	--	10	--	Gauss

Note: 1G (Gauss) = 0.1mT (millitesta)

Output Behavior versus Magnetic Pole

DC Operating Parameters: T_A = -40 to 125°C, V_{CC} = 1.8V ~ 6V

Parameter	Test condition	OUT
South pole	B < B _{op} [(-55) ~ (-10)]	Low
Null or weak magnetic field	B = 0 or B < B _{RP}	High
North pole	B > B _{op} (55 ~ 10)	Low

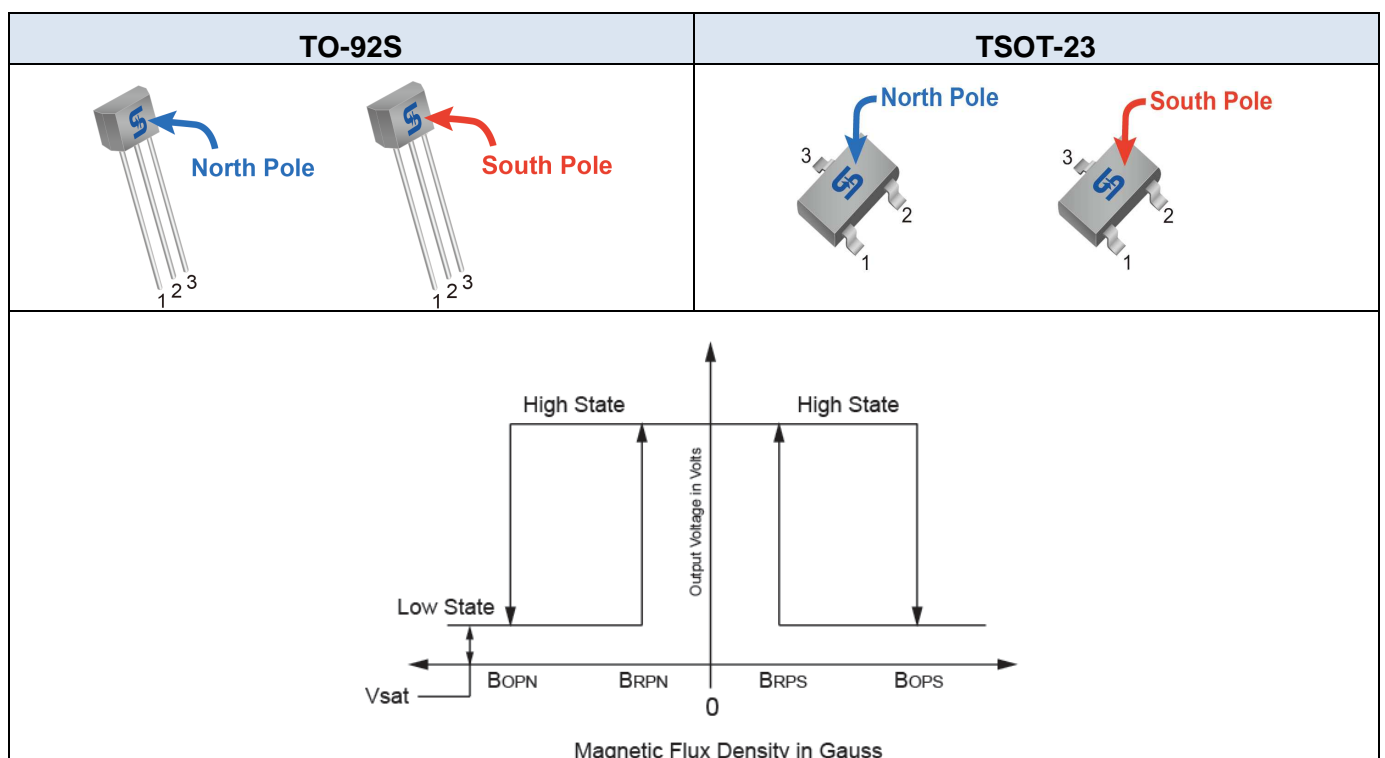

Characteristic Performance

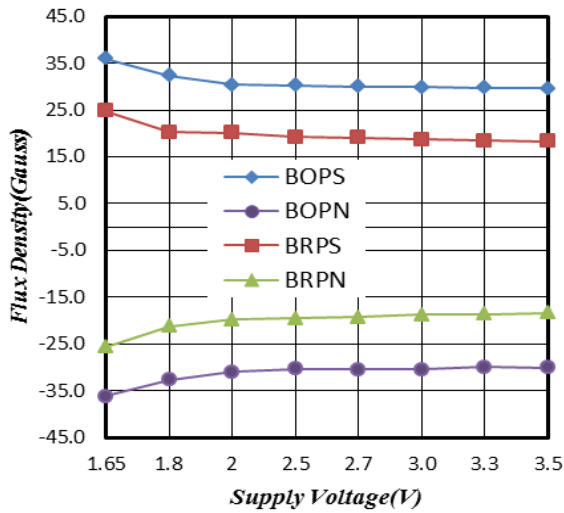

Figure 1. Supply Voltage vs. Flux Density

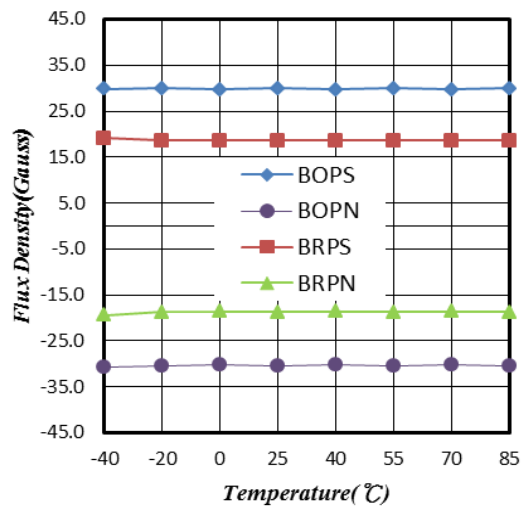

Figure 2. Temperature vs. Flux Density

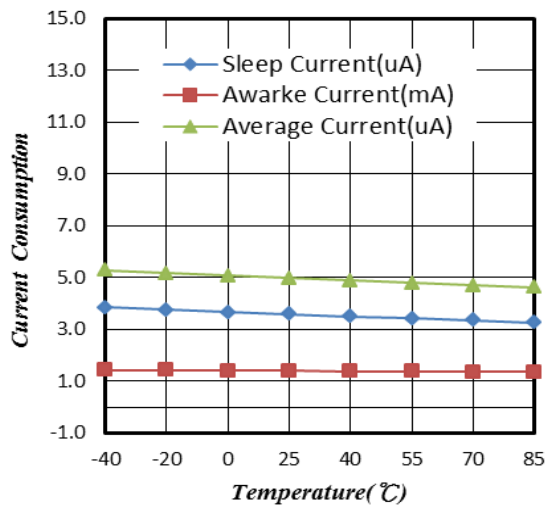

Figure 3. Supply Current vs. Temperature

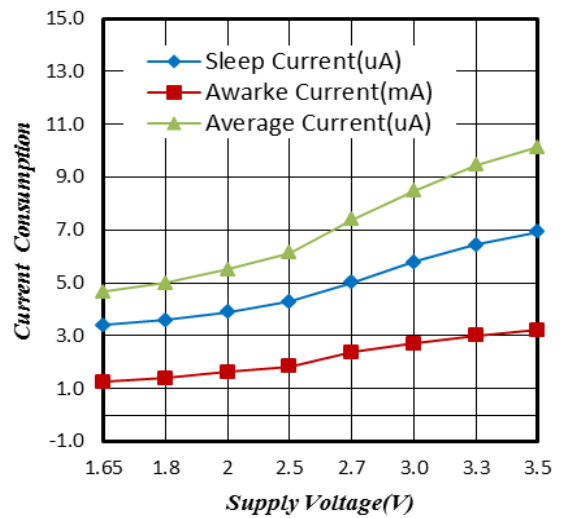

Figure 4. Supply Current vs. Supply Voltage

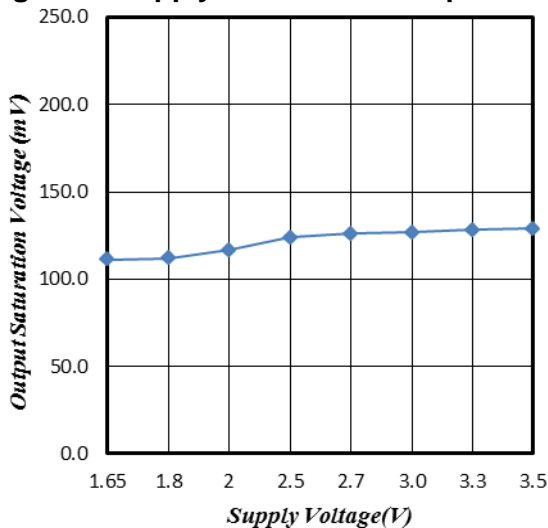

Figure 5. Output Saturation Voltage vs. Supply Voltage

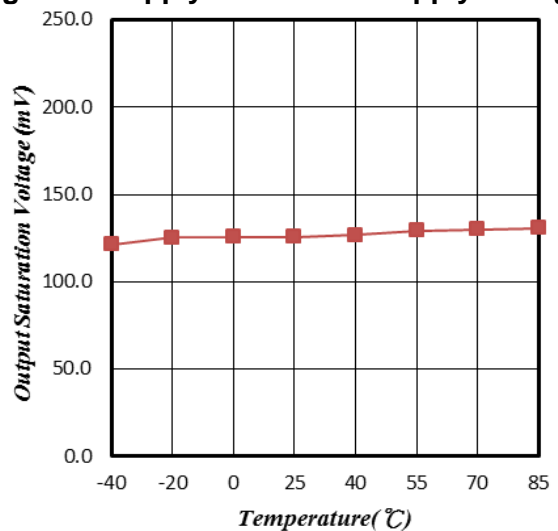

Figure 6. Output Saturation Voltage vs. Temperature

Characteristic Performance

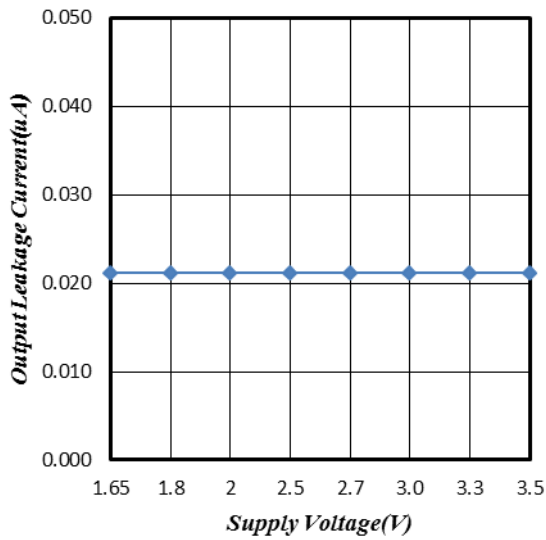

Figure 7. Output Leakage Current vs. Supply Voltage

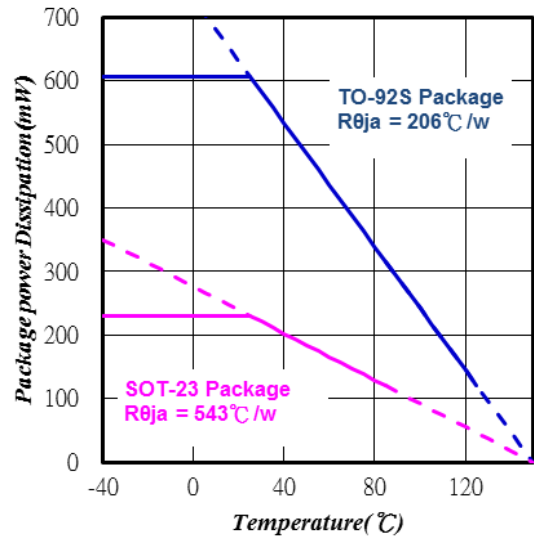
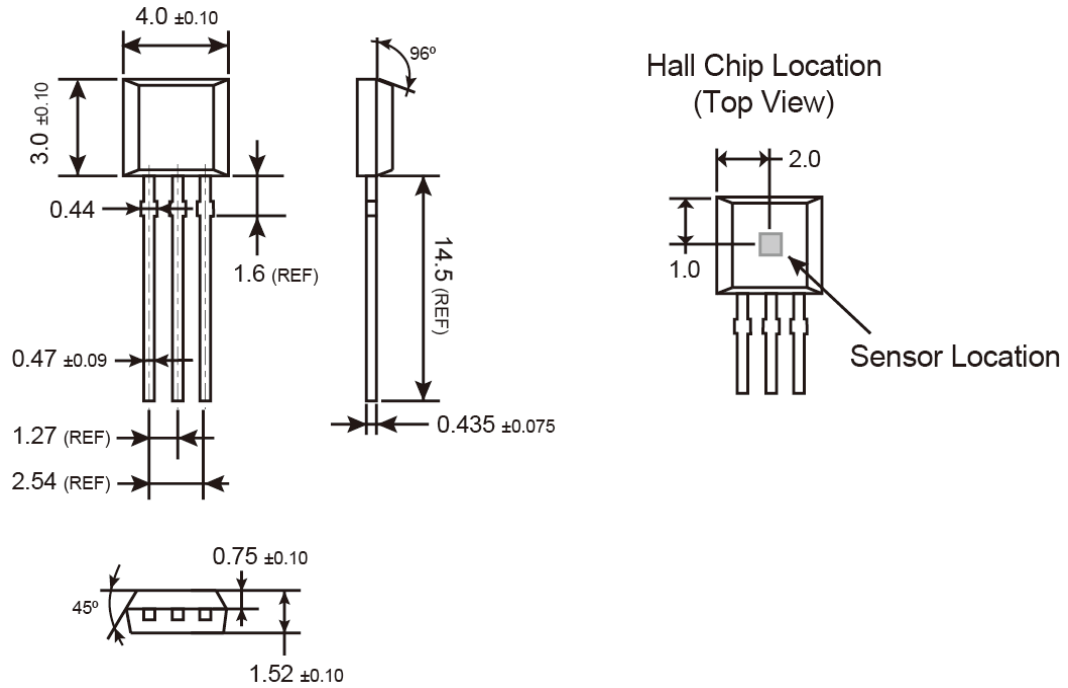

Figure 8. Power Dissipation vs. Temperature

TO-92S Mechanical Drawing



Unit: Millimeters

Marking Diagram

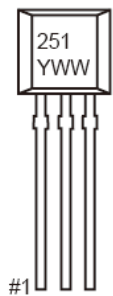

251 = Device Code
Y = Year Code (4=2014, 5=2015....)
WW = Week Code (01~52)

TSOT-23 Mechanical Drawing

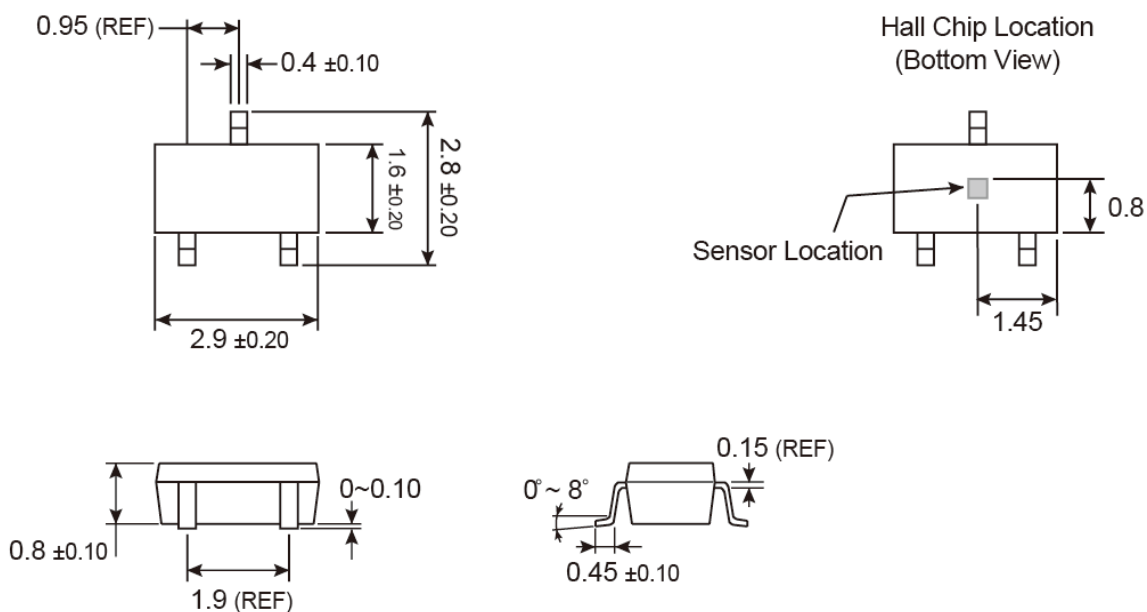

Unit: Millimeters

Marking Diagram

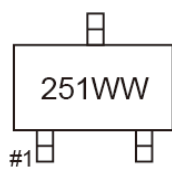

251 = Device Code

WW = Week Code Table

week	1	2	3	4	5	6	7	8	9	10	11	12	13
code	QA	QB	QC	QD	QE	QF	QG	QH	QI	QJ	QK	QL	QM
week	14	15	16	17	18	19	20	21	22	23	24	25	26
code	QN	QO	QP	QQ	QR	QS	QT	QU	QV	QW	QX	QY	QZ
week	27	28	29	30	31	32	33	34	35	36	37	38	39
code	RA	RB	RC	RD	RE	RF	RG	RH	RI	RJ	RK	RL	RM
week	40	41	42	43	44	45	46	47	48	49	50	51	52
code	RN	RO	RR	RO	RR	RS	RT	RU	RV	RW	RX	RY	RZ

Notice

Specifications of the products displayed herein are subject to change without notice. TSC or anyone on its behalf, assumes no responsibility or liability for any errors or inaccuracies.

Information contained herein is intended to provide a product description only. No license, express or implied, to any intellectual property rights is granted by this document. Except as provided in TSC's terms and conditions of sale for such products, TSC assumes no liability whatsoever, and disclaims any express or implied warranty, relating to sale and/or use of TSC products including liability or warranties relating to fitness for a particular purpose, merchantability, or infringement of any patent, copyright, or other intellectual property right.

The products shown herein are not designed for use in medical, life-saving, or life-sustaining applications. Customers using or selling these products for use in such applications do so at their own risk and agree to fully indemnify TSC for any damages resulting from such improper use or sale.