

KEMET Part Number: SSHB21HS-R25044
(UALSB2SR250440)

KEMET, SSHB21HS, AC Line Filters, Dual Mode, 4400 uH

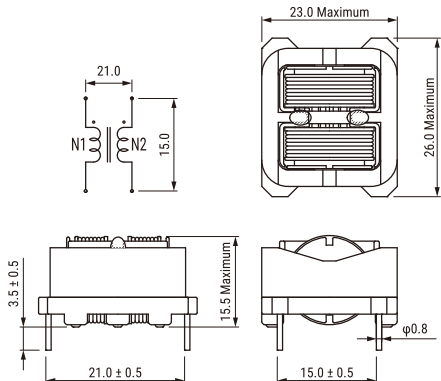

Dimensions

L	26mm MAX
T	23mm MAX
H	15.5mm MAX
LL	3.5mm +/-0.5mm
S	21mm +/-0.5mm

Packaging Specifications

Packaging:	Tray
Packaging Quantity:	360
Weight:	14 g

General Information

Series:	SSHB21HS
Style:	Through-Hole
RoHS:	Yes
Notes:	Marking: R25 Lot No.
Miscellaneous:	Temperature Rise Maximum: 50 K

Specifications

Voltage AC:	250 VAC
Inductance:	4.4 mH (10 kHz)
Current:	2.5 A
Temperature Range:	-25/+120°C
DC Resistance:	90 mOhms