



High-Linearity 1700MHz to 2200MHz Down-Conversion Mixer with LO Buffer/Switch

MAX9993

General Description

The MAX9993 high-linearity down-conversion mixer provides 8.5dB of gain, +23.5dBm IIP3, and 9.5dB NF for UMTS, DCS, and PCS base-station applications.

The MAX9993 integrates baluns in the RF and LO ports, a dual-input LO selectable switch, an LO buffer, a double-balanced mixer, and a differential IF output amplifier. The MAX9993 requires a typical LO drive of +3dBm, and supply current is guaranteed to below 230mA.

The MAX9993 is available in a compact 20-pin thin QFN package (5mm x 5mm) with an exposed pad. Electrical performance is guaranteed over the extended -40°C to +85°C temperature range.

The MAX9993 EV kit is available; contact the factory for more information.

Features

- ◆ +23.5dBm Input IIP3
- ◆ 1700MHz to 2200MHz RF Frequency Range
- ◆ 40MHz to 350MHz IF Frequency Range
- ◆ 1400MHz to 2000MHz LO Frequency Range
- ◆ 8.5dB Conversion Gain
- ◆ 9.5dB Noise Figure
- ◆ Integrated LO Buffer
- ◆ Switch-Selectable (SPDT), Two LO Inputs
- ◆ Low 0 to +6dBm LO Drive
- ◆ 40dB LO1-to-LO2 Isolation

Applications

- UMTS and 3G Base Stations
- DCS1800 and EDGE Base Stations
- PCS1900 Base Stations
- Point-to-Point Microwave Systems
- Wireless Local Loop
- Private Mobile Radio
- Military Systems

Ordering Information

PART	TEMP RANGE	PIN-PACKAGE
MAX9993ETP-T	-40°C to 85°C	20 Thin QFN-EP*

*EP = Exposed pad.

Pin Configuration/Functional Diagram

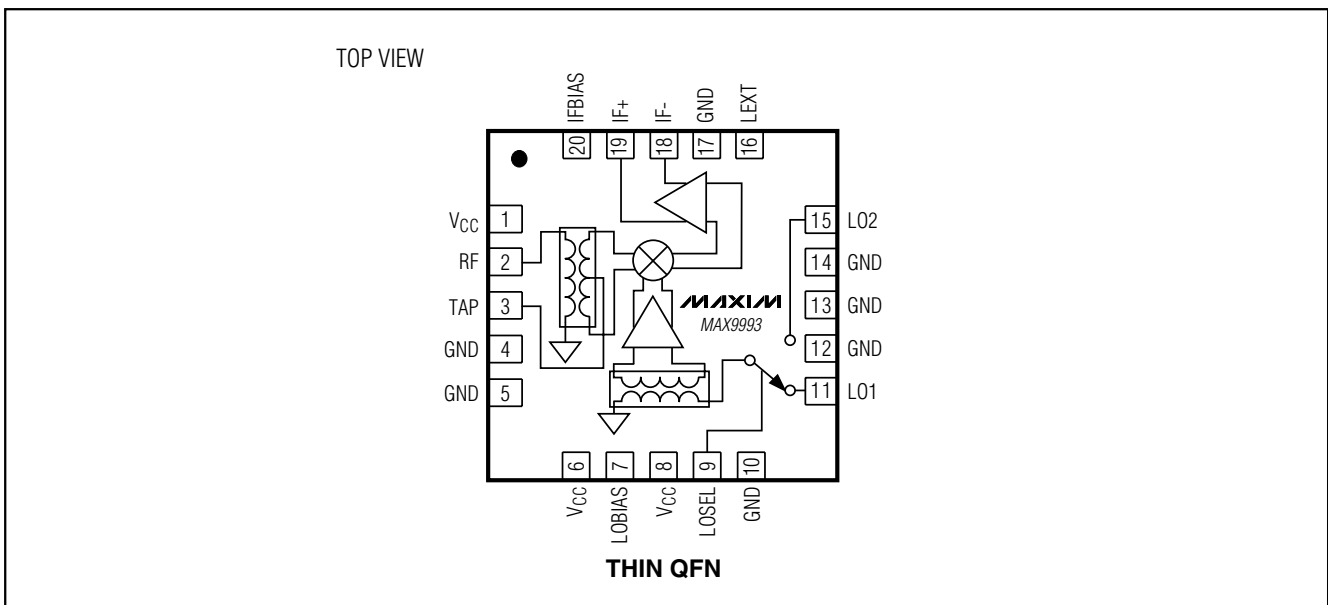

High-Linearity 1700MHz to 2200MHz Down-Conversion Mixer with LO Buffer/Switch

ABSOLUTE MAXIMUM RATINGS

V _{CC}	-0.3V to 5.5V	Continuous Power Dissipation (T _A = +70°C) 20-Lead Thin QFN (derate 30.3mW/°C above T _A = +70°C)	2200mW
RF (RF is DC shorted to GND through balun).....	50mA	θ _{JA}	33°C/W
LO1, LO2 to GND	±0.3V	Operating Temperature Range	-40°C to +85°C
TAP, IF+, IF- to GND	-0.3V to (V _{CC} + 0.3V)	Storage Temperature Range	-65°C to +150°C
LOSEL to GND	-0.3V to (V _{CC} (pin 8) + 0.3V)	Lead Temperature (soldering, 10s)	+300°C
LOBIAS, IFBIAS, LEXT to GND	-0.3V to (V _{CC} + 0.3V)		
RF and LO Input Power	+22dBm		

Stresses beyond those listed under "Absolute Maximum Ratings" may cause permanent damage to the device. These are stress ratings only, and functional operation of the device at these or any other conditions beyond those indicated in the operational sections of the specifications is not implied. Exposure to absolute maximum rating conditions for extended periods may affect device reliability.

DC ELECTRICAL CHARACTERISTICS

(Typical Operating Circuit as shown, no input RF or LO signals applied. V_{CC} = 4.75V to 5.25V, T_A = -40°C to +85°C. Typical values are at V_{CC} = 5.0V and T_A = +25°C, unless otherwise noted.)

PARAMETER	SYMBOL	CONDITIONS	MIN	TYP	MAX	UNITS
Supply Voltage	V _{CC}		4.75	5.00	5.25	V
Supply Current	I _{CC}	Total supply current		202	230	mA
		V _{CC} (pin 8)		87	105	
		IF+/IF- (total of both)		103	133	
LOSEL Input High Voltage	V _{IH}		2.0			V
LOSEL Input Low Voltage	V _{IL}				0.8	V
LOSEL Input Current	I _{IL} and I _{IH}		-5		+5	μA

AC ELECTRICAL CHARACTERISTICS

(Typical Operating Circuit, 4.75V < V_{CC} < 5.75V, -40°C < T_A < +85°C, RF and LO ports are driven from 50Ω sources, 0dBm < P_{LO} < +6dBm, P_{RF} = -5dBm, 1700MHz < f_{RF} < 2200MHz, 1400MHz < f_{LO} < 2000MHz, f_{IF} = 200MHz. Typical values are for T_A = +25°C V_{CC} = 5.0V, P_{LO} = +3dBm, f_{RF} = 1900MHz, f_{LO} = 1700MHz, 200MHz IF.) (Notes 1, 2)

PARAMETER	SYMBOL	CONDITIONS	MIN	TYP	MAX	UNITS
RF Frequency	f _{RF}		1700		2200	MHz
LO Frequency	f _{LO}	(Note 6)	1400		2000	MHz
IF Frequency	f _{IF}		50		350	MHz
Conversion Gain	G _C	(Note 3)		8.5		dB
Gain Variation Over Temperature		T _A = -40°C to +85°C		0.0012		dB/°C
Gain Variation from Nominal (3σ)				0.45		dB
Input Compression Point	P _{1dB}			12.6		dBm
Input Third-Order Intercept Point (Note 3)	IIP3	Two RF tones: -5dBm each at 1950MHz and 1951MHz, LO: +3dBm at 1750MHz		24		dBm
		Two RF tones: -5dBm each at 2200MHz and 2201MHz, LO: +3dBm at 2000MHz		23		

High-Linearity 1700MHz to 2200MHz Down-Conversion Mixer with LO Buffer/Switch

MAX9993

AC ELECTRICAL CHARACTERISTICS (continued)

(Typical Operating Circuit, 4.75V < V_{CC} < 5.75V, -40°C < T_A < +85°, RF and LO ports are driven from 50Ω sources, 0dBm < P_{LO} < +6dBm, P_{RF} = -5dBm, 1700MHz < f_{RF} < 2200MHz, 1400MHz < f_{LO} < 2000MHz, f_{IF} = 200MHz. Typical values are for T_A = +25°C V_{CC} = 5.0V, P_{LO} = +3dBm, f_{RF} = 1900MHz, f_{LO} = 1700MHz, 200MHz IF.) (Notes 1, 2)

PARAMETER	SYMBOL	CONDITIONS		MIN	TYP	MAX	UNITS
IIP3 Variation Over Temperature		T _A = -40°C to +85°C			±0.5		dB
Noise Figure	NF	f _{RF} = 1950MHz, f _{LO} = 1750MHz, measured single-side band			9.5		dB
Required LO Drive	P _{LO}			0	3	6	dBm
Spurious Response at IF	2 × 2	2 RF - 2 LO P _{RF} = -5dBm f _{RF} = 1950MHz f _{LO} = 1750MHz f _{SPUR} = 1850MHz	P _{LO} = +3dBm		65		dBc
			P _{LO} = +6dBm		70		
	3 × 3	3 RF - 3 LO P _{RF} = -5dBm f _{RF} = 1950MHz f _{LO} = 1750MHz f _{SPUR} = 1816.66MHz	P _{LO} = +3dBm		67		
			P _{LO} = +6dBm		68		
Maximum LO-to-RF Leakage		P _{LO} = 0dBm to +6dBm, f _{LO} = 1400MHz to 2000MHz			-19		dBm
Maximum LO-to-IF Leakage		P _{LO} = 0dBm to +6dBm, f _{LO} = 1400MHz to 2000MHz			-21		dBm
Minimum RF-to-IF Isolation		f _{RF} = 1700MHz to 2200MHz			37		dB
Conversion Loss, LO to IF		P _{LO} = +0dBm, inject -20dBm at 200MHz into LO port, measure 200MHz at IF			28		dB
LO Switching Time		50% of LOSEL to IF settled to within 2 degrees			<50		ns
LO1-to-LO2 Isolation		(Note 4)			40		dB
RF Return Loss					19		dB
LO Return Loss		LO port selected			15		dB
		LO port unselected			14		
IF Return Loss		RF terminated, P _{LO} = +3dBm (Note 5)			15		dB

Note 1: Guaranteed by design and characterization.

Note 2: All limits reflect losses of external components. Output measurements taken at IFOUT of the *Typical Application Circuit*.

Note 3: Production tested.

Note 4: Measured at IF port at IF frequency. f_{LO1} and f_{LO2} are offset by 1MHz, P_{LO1} = P_{LO2} = +3dBm.

Note 5: IF return loss can be optimized by external matching components.

Note 6: Operation outside this range is possible, but with degraded performance of some specifications.

High-Linearity 1700MHz to 2200MHz Down-Conversion Mixer with LO Buffer/Switch

Typical Operating Characteristics

(MAX9993 EV Kit, $V_{CC} = 5.0V$, $P_{RF} = -5dBm$, $P_{LO} = +3dBm$, LO is low-side injected for a 200MHz IF, $T_A = +25^{\circ}C$. For high-side LO injection curves, LO frequency is beyond maximum specified range, and is shown for completeness.)

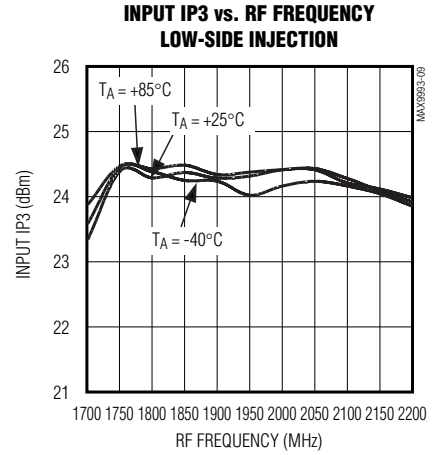
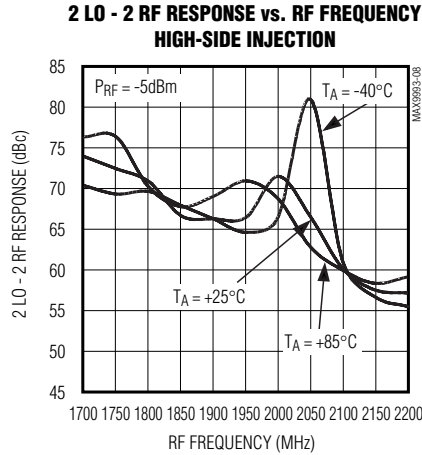
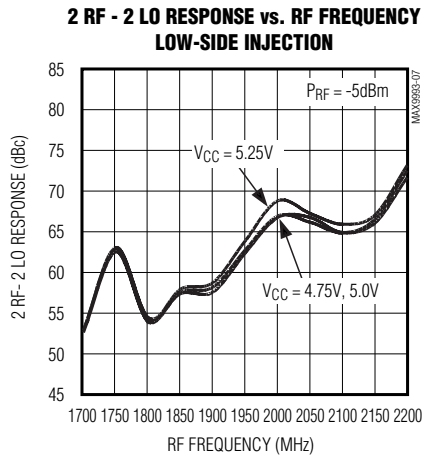
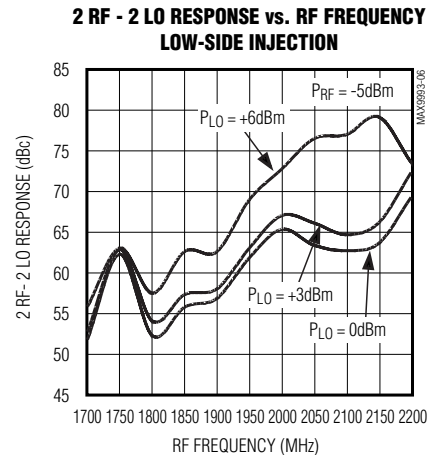
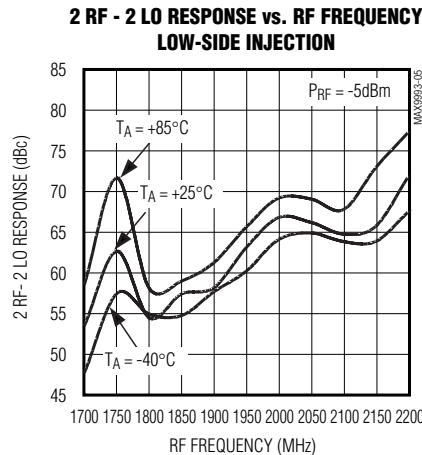
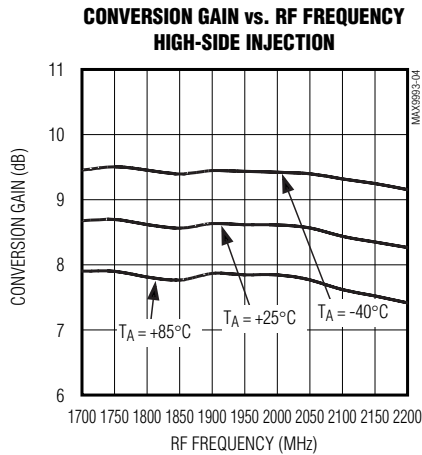
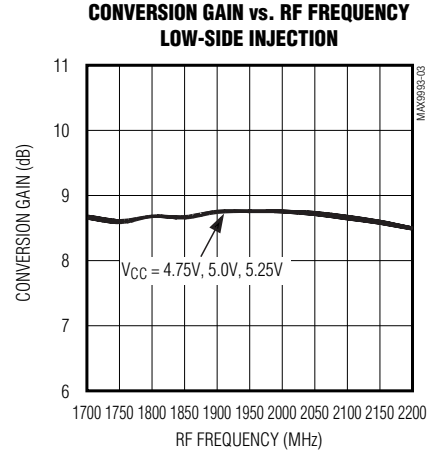
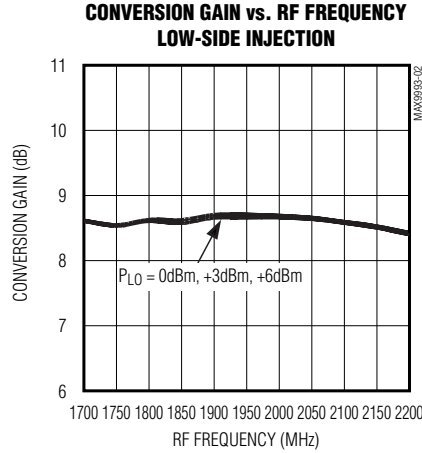
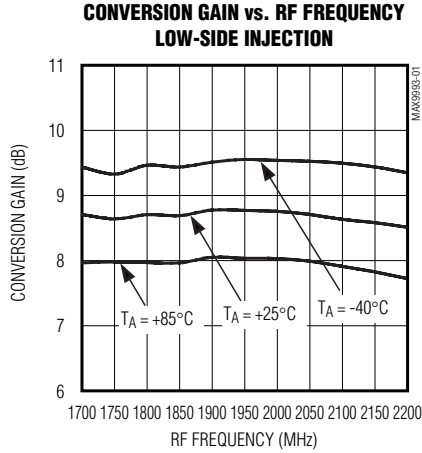

High-Linearity 1700MHz to 2200MHz Down-Conversion Mixer with LO Buffer/Switch

Typical Operating Characteristics (continued)

(MAX9993 EV Kit, $V_{CC} = 5.0V$, $P_{RF} = -5dBm$, $P_{LO} = +3dBm$, LO is low-side injected for a 200MHz IF, $T_A = +25^\circ C$. For high-side LO injection curves, LO frequency is beyond maximum specified range, and is shown for completeness.)

MAX9993

**INPUT IP3 vs. RF FREQUENCY
LOW-SIDE INJECTION**

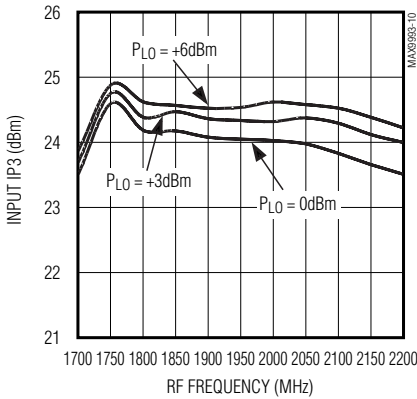

**INPUT IP3 vs. RF FREQUENCY
LOW-SIDE INJECTION**

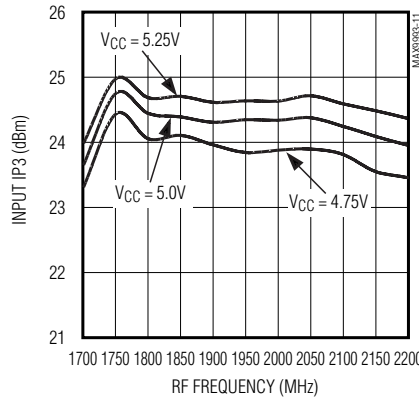

**INPUT IP3 vs. RF FREQUENCY
HIGH-SIDE INJECTION**

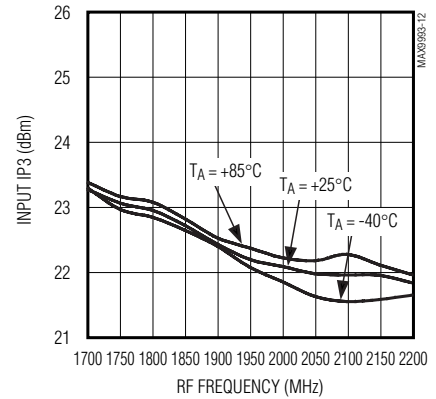

**INPUT P1dB vs. RF FREQUENCY
LOW-SIDE INJECTION**

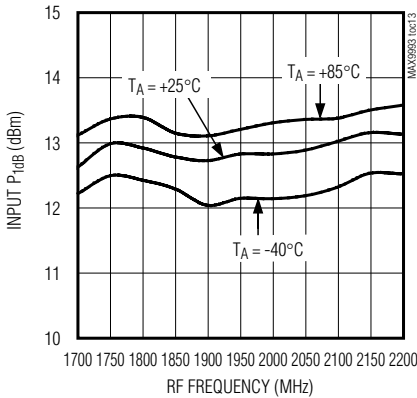

**INPUT P1dB vs. RF FREQUENCY
LOW-SIDE INJECTION**

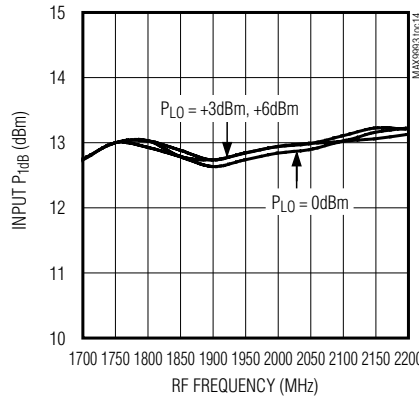

**INPUT P1dB vs. RF FREQUENCY
LOW-SIDE INJECTION**

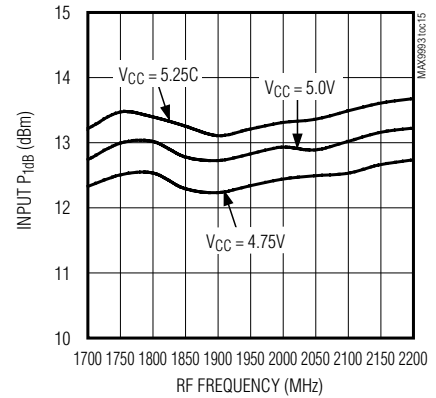

**INPUT P1dB vs. RF FREQUENCY
HIGH-SIDE INJECTION**

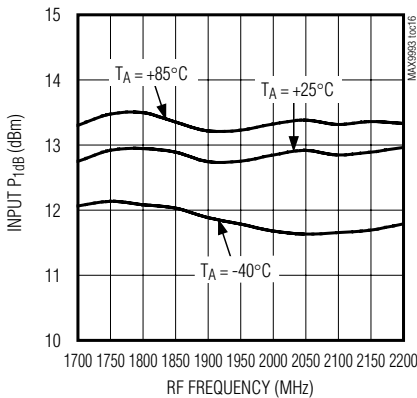

**LO SWITCH ISOLATION vs. RF FREQUENCY
LOW-SIDE INJECTION**

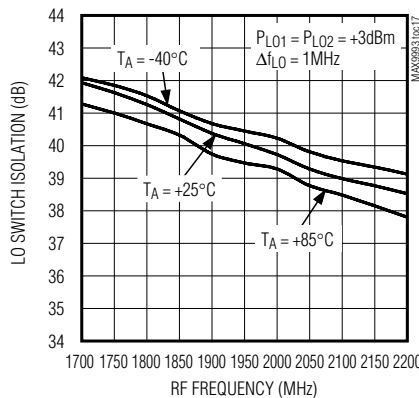

**LO SWITCH ISOLATION vs. RF FREQUENCY
LOW-SIDE INJECTION**

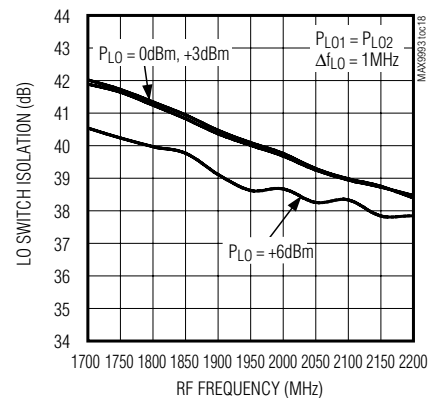

High-Linearity 1700MHz to 2200MHz Down-Conversion Mixer with LO Buffer/Switch

Typical Operating Characteristics (continued)

(MAX9993 EV Kit, $V_{CC} = 5.0V$, $P_{RF} = -5dBm$, $P_{LO} = +3dBm$, LO is low-side injected for a 200MHz IF, $T_A = +25^\circ C$. For high-side LO injection curves, LO frequency is beyond maximum specified range, and is shown for completeness.)

**LO SWITCH ISOLATION vs. RF FREQUENCY
LOW-SIDE INJECTION**

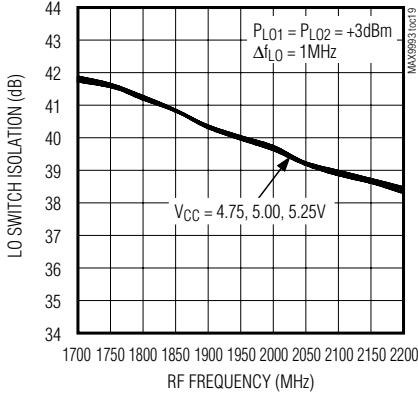

**LO SWITCH ISOLATION vs. RF FREQUENCY
HIGH-SIDE INJECTION**

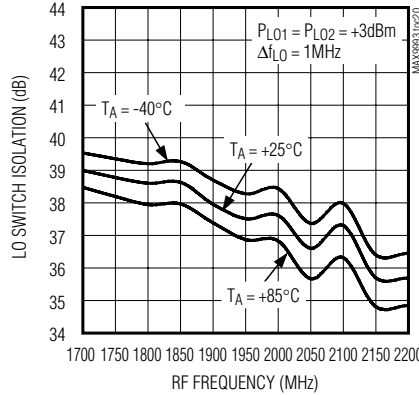

**LO LEAKAGE AT IF PORT
vs. LO FREQUENCY**

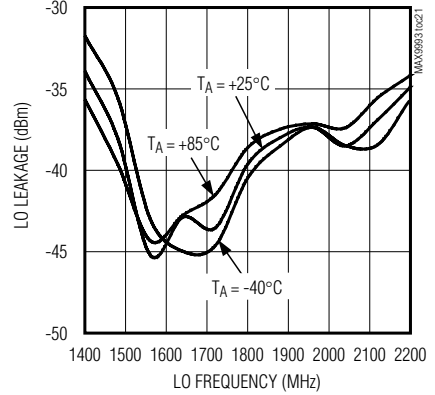

**LO LEAKAGE AT IF PORT
vs. LO FREQUENCY**

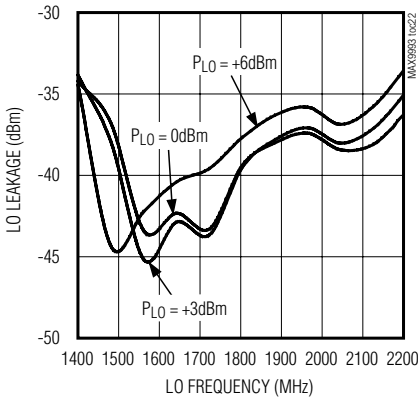

**LO LEAKAGE AT IF PORT
vs. LO FREQUENCY**

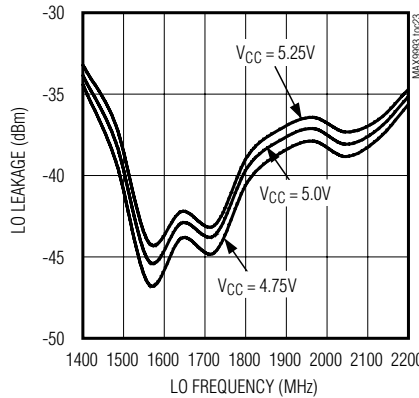

**LO LEAKAGE AT RF PORT
vs. LO FREQUENCY**

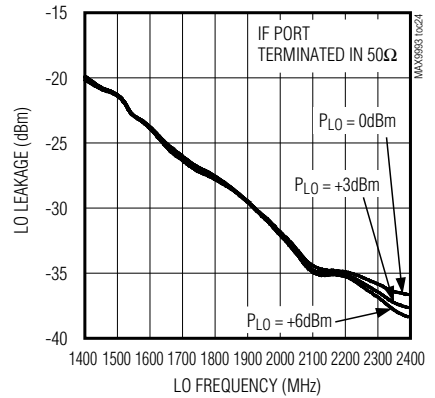

RF-TO-IF ISOLATION vs. FREQUENCY

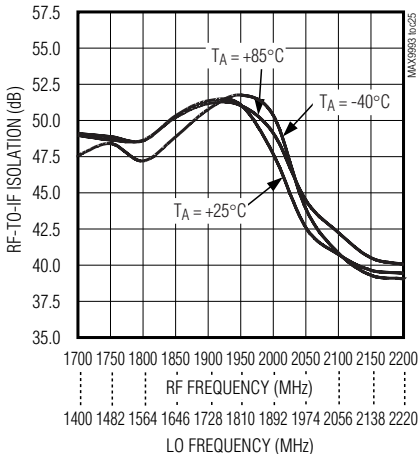

RF-TO-IF ISOLATION vs. RF FREQUENCY

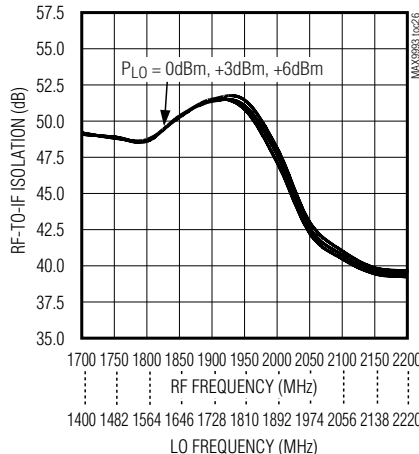

RF-TO-IF ISOLATION vs. RF FREQUENCY

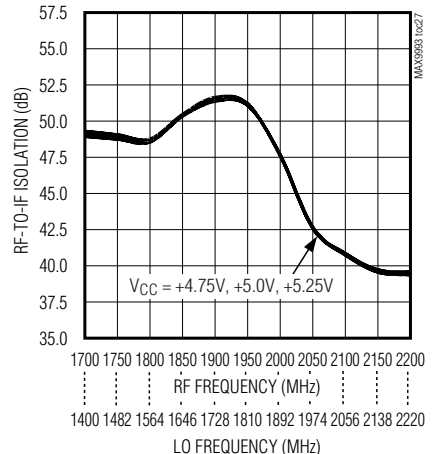

High-Linearity 1700MHz to 2200MHz Down-Conversion Mixer with LO Buffer/Switch

MAX9993

Typical Operating Characteristics (continued)

(MAX9993 EV Kit, $V_{CC} = 5.0V$, $P_{RF} = -5dBm$, $P_{LO} = +3dBm$, LO is low-side injected for a 200MHz IF, $T_A = +25^\circ C$. For high-side LO injection curves, LO frequency is beyond maximum specified range, and is shown for completeness.)

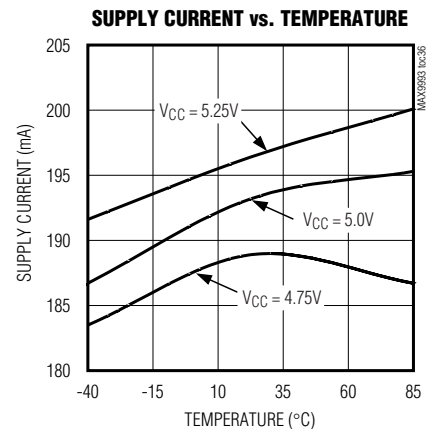
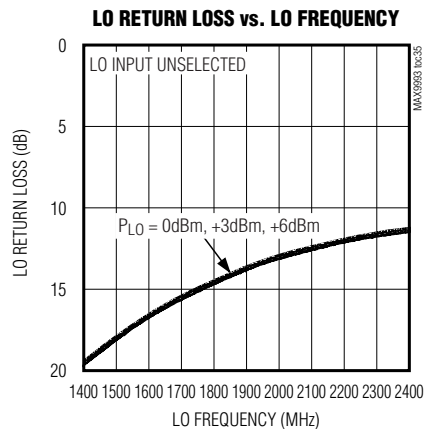
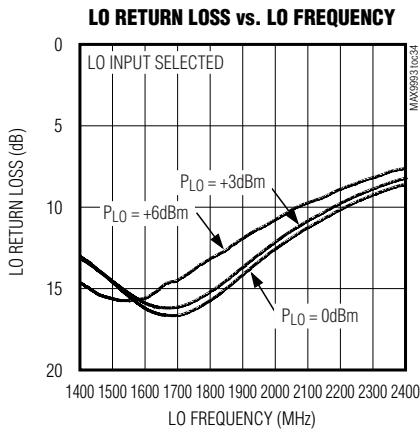
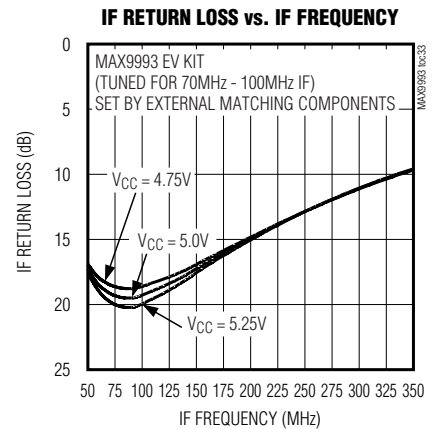
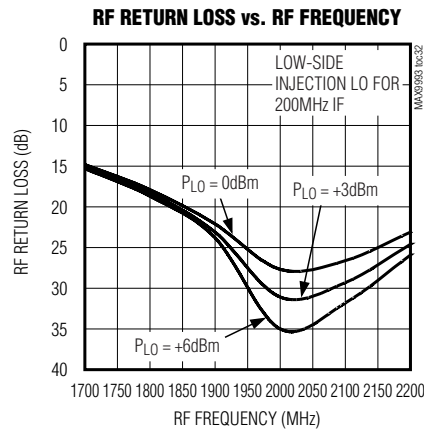
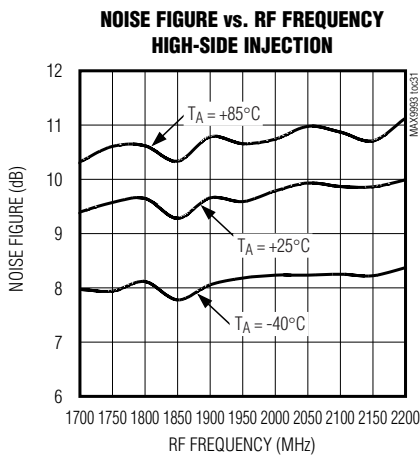
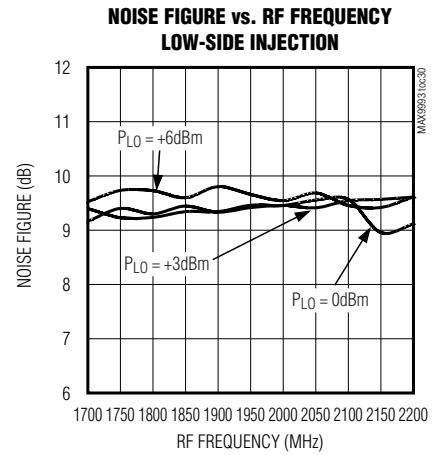
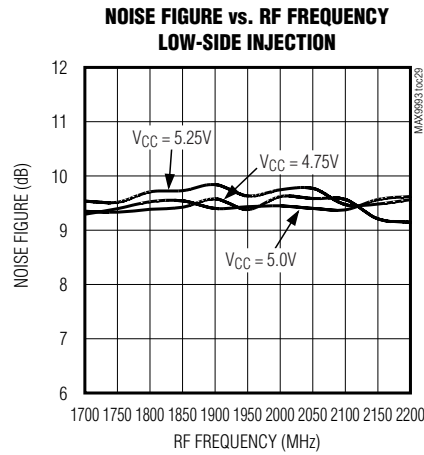
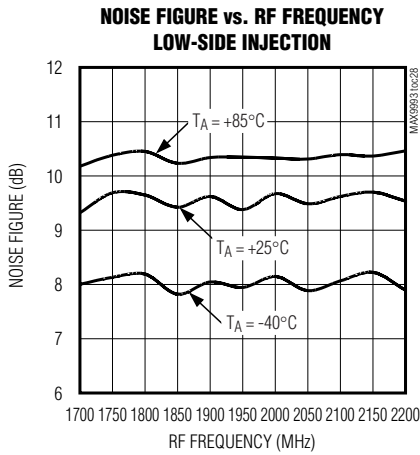

High-Linearity 1700MHz to 2200MHz Down-Conversion Mixer with LO Buffer/Switch

Pin Description

PIN	NAME	FUNCTION
1, 6, 8	VCC	Power Supply Connections. See the <i>Typical Application Circuit</i> .
2	RF	Single-Ended 50Ω RF Input. This port is internally matched and DC shorted to GND through a balun. Provide a DC-blocking capacitor if required.
3	TAP	Center Tap of the Internal RF Balun. Bypass with capacitors close to the IC, as shown in the <i>Typical Application Circuit</i> .
4, 5, 10, 12, 13, 14, 17, EP	GND	Ground. Connect to supply ground. Provide multiple vias in the PC board to create a low-inductance connection between the exposed paddle (EP) and the PC board ground.
7	LOBIAS	LO Output Bias Resistor for LO Buffer. Connect a 383Ω (±1%) from LOBIAS to GND.
9	LOSEL	LO Select. Logic control input for selecting LO1 or LO2.
11	LO1	Local Oscillator Input. LO1 selected when LOSEL is low.
15	LO2	Local Oscillator Input. LO2 selected when LOSEL is high.
16	LEXT	External Inductor Connection. Connect a low-ESR 10nH inductor from LEXT to GND. This inductor carries approximately 100mA DC current.
18	IF-	Noninverting IF Output. Requires external bias to VCC through an RF choke (see the <i>Typical Application Circuit</i>).
19	IF+	Inverting IF Output. Requires external bias to VCC through an RF choke (see the <i>Typical Application Circuit</i>).
20	IFBIAS	IF Bias Resistor Connection for IF Amplifier. Connect a 523Ω (±1%) from IFBIAS to GND.

Detailed Description

The MAX9993 high-linearity down-conversion mixer provides 8.5dB of gain and +23.5dBm IIP3, with a 9.5dB noise figure (typ). Integrated baluns and matching circuitry allow 50Ω single-ended interfaces to the RF and LO ports. A single-pole, double-throw (SPDT) LO switch provides 50ns switching time between LO inputs, with typically 40dB LO-to-LO isolation. Furthermore, the integrated LO buffer provides a high drive level to the mixer core, reducing the LO drive required at the MAX9993's inputs to 0dBm to +6dBm range. The IF port incorporates a differential output, which is ideal for providing enhanced IIP2 performance.

Specifications are guaranteed over broad frequency ranges to allow for use in UMTS and 2G/2.5G/3G DCS1800 and PCS1900 base stations. The MAX9993 is specified to operate over an RF input range of 1700MHz to 2200MHz, an LO range of 1400MHz to 2000MHz, and an IF range of 40MHz to 350MHz. This device can operate in high-side LO injection applications with an extended LO range, but performance degrades gently as f_{LO} continues to increase. See the *Typical Operating Characteristics* for measurements taken with f_{LO} up to 2400MHz. This device is available in a compact 5mm × 5mm 20-pin thin QFN package with an exposed pad.

RF Input and Balun

The MAX9993 has one input (RF) that is internally matched to 50Ω, requiring no external matching components. A DC-blocking capacitor is required, because the input is internally DC shorted to ground through the on-chip balun. Input return loss is better than 15dB over the entire RF frequency range of 1700MHz to 2200MHz.

LO Input, Switch, Buffer, and Balun

The mixer can be used for either high-side or low-side injection applications with an LO frequency range of 1400MHz to 2000MHz. An internal LO SPDT switch selects one of two single-ended LO ports. This allows the external oscillator to settle on a particular frequency before it is switched in. LO switching time is guaranteed to be less than 50ns. This switch is controlled by a digital input (LOSEL): logic low selects LO1, logic high selects LO2. LO1 and LO2 inputs are internally matched to 50Ω, requiring only a 22pF DC-blocking capacitor.

A two-stage internal LO buffer allows a wide input power range for the LO drive. All guaranteed specifications are for an LO signal power from 0dBm to +6dBm. A low-loss balun along with an LO buffer drives the double-balanced mixer. All interfacing and matching from the LO inputs to the IF outputs are integrated on-chip.

High-Linearity 1700MHz to 2200MHz Down-Conversion Mixer with LO Buffer/Switch

MAX9993

Table 1. Component List

COMPONENT	VALUE	SIZE	DESCRIPTION
C1	4pF	0603	Microwave capacitor
C2, C6, C7, C9, C10	22pF	0603	Microwave capacitors
C3, C5, C8	0.01 μ F	0603	Capacitors
C4	10pF	0603	Microwave capacitor
C11, C12, C13	150pF	0603	Microwave capacitors
L1, L2	470nH	1008	Wire-wound high-Q inductors
L3	10nH	0805	Wire-wound high-Q inductor
R1	523 Ω	0603	\pm 1% resistor
R2	383 Ω	0603	\pm 1% resistor
R3, R4	7.2 Ω	1206	\pm 1% resistors
R5	200 Ω	0603	\pm 5% resistor
T1	4:1 (200:50)	—	IF balun

High-Linearity Mixer

The core of the MAX9993 is a double-balanced, high-performance passive mixer. Exceptional linearity is provided by the large LO swing from the on-chip LO buffer; IIP3 is typically +23.5dBm, IIP2 is typically +60dBm, and total cascaded NF is 9.5dB.

Differential IF Output Amplifier

The MAX9993 mixer has an IF frequency range of 40MHz to 350MHz. The differential, open-collector IF output ports require external pullup inductors to V_{CC} . Single-ended IF applications require a 4:1 balun to transform the 200 Ω differential output impedance to a 50 Ω single-ended output. After the balun, VSWR is typically 1.5:1.

Applications Information

Input and Output Matching

The RF and LO inputs are internally matched to 50 Ω . No matching components are required. Return loss at the RF port is better than 15dB over the entire input range, 1700MHz to 2200MHz, and return loss at LO1 and LO2 is better than 10dB from 1400MHz to 2000MHz. RF and LO inputs require only DC-blocking capacitors for interfacing. These DC-blocking capacitors can be part of the matching circuit.

The IF output impedance is 200 Ω differential out of the IC. An external low-loss 4:1 balun brings this impedance down to a 50 Ω single-ended output (see the *Typical Application Circuit*).

Bias Resistors

Bias currents for the LO buffer and the IF amplifier were optimized by fine-tuning the resistors at LOBIAS and IFBIAS during characterization at the factory. These currents should not be adjusted. If the 383 Ω (\pm 1%) and/or 523 Ω (\pm 1%) resistor values are not readily available, substitute standard \pm 5% values: 390 Ω and 520 Ω , respectively.

Layout Considerations

A properly designed PC board is an essential part of any RF/microwave circuit. Keep RF signal lines as short as possible to reduce losses, radiation, and inductance. For best performance, route the ground pin traces directly to the exposed pad underneath the package. This pad should be connected to the ground plane of the board by using multiple vias under the device to provide the best RF/thermal conduction path. Solder the exposed pad on the bottom of the device package to a PC board exposed pad.

Power Supply Bypassing

Proper voltage supply bypassing is essential for high-frequency circuit stability. Bypass each V_{CC} pin and TAP with the capacitors shown in the typical application circuit. Place the TAP bypass capacitor to ground within 100 mils of the TAP pin.

Chip Information

TRANSISTOR COUNT: 989

PROCESS: SiGe BiCMOS

High-Linearity 1700MHz to 2200MHz Down-Conversion Mixer with LO Buffer/Switch

Typical Application Circuit

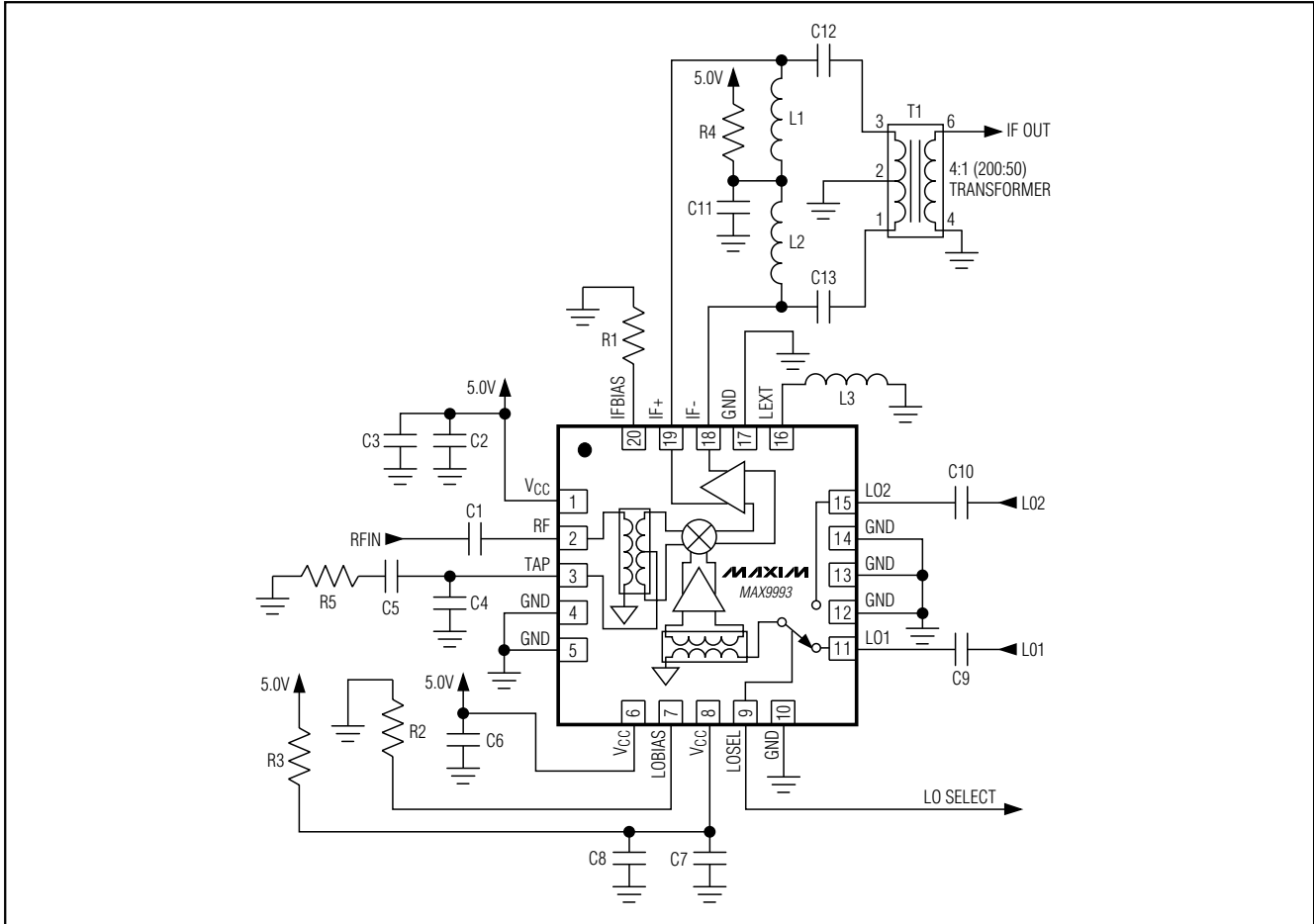

High-Linearity 1700MHz to 2200MHz Down-Conversion Mixer with LO Buffer/Switch

Package Information

(The package drawing(s) in this data sheet may not reflect the most current specifications. For the latest package outline information, go to www.maxim-ic.com/packages.)

MAX9993

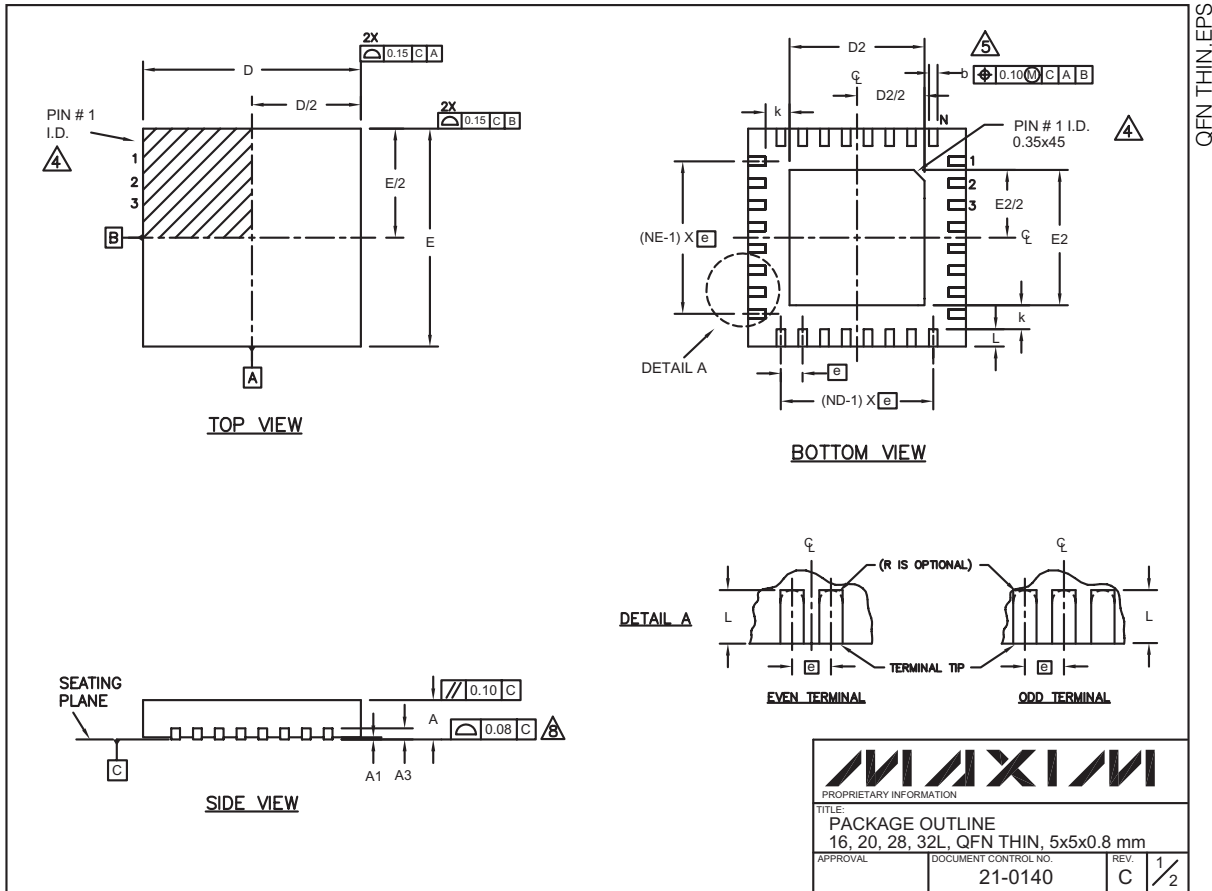

High-Linearity 1700MHz to 2200MHz Down-Conversion Mixer with LO Buffer/Switch

Package Information (continued)

(The package drawing(s) in this data sheet may not reflect the most current specifications. For the latest package outline information, go to www.maxim-ic.com/packages.)

COMMON DIMENSIONS												
PKG.	16L 5x5			20L 5x5			28L 5x5			32L 5x5		
SYMBOL	MIN.	NOM.	MAX.	MIN.	NOM.	MAX.	MIN.	NOM.	MAX.	MIN.	NOM.	MAX.
A	0.70	0.75	0.80	0.70	0.75	0.80	0.70	0.75	0.80	0.70	0.75	0.80
A1	0	0.02	0.05	0	0.02	0.05	0	0.02	0.05	0	0.02	0.05
A3	0.20 REF.			0.20 REF.			0.20 REF.			0.20 REF.		
b	0.25	0.30	0.35	0.25	0.30	0.35	0.20	0.25	0.30	0.20	0.25	0.30
D	4.90	5.00	5.10	4.90	5.00	5.10	4.90	5.00	5.10	4.90	5.00	5.10
E	4.90	5.00	5.10	4.90	5.00	5.10	4.90	5.00	5.10	4.90	5.00	5.10
e	0.80 BSC.			0.65 BSC.			0.50 BSC.			0.50 BSC.		
k	0.25	-	-	0.25	-	-	0.25	-	-	0.25	-	-
L	0.45	0.55	0.65	0.45	0.55	0.65	0.45	0.55	0.65	0.30	0.40	0.50
N	16			20			28			32		
ND	4			5			7			8		
NE	4			5			7			8		
JEDEC	WHHB			WHHC			WHHD-1			WHHD-2		

EXPOSED PAD VARIATIONS								
PKG. CODES	D2			E2				
	MIN.	NOM.	MAX.	MIN.	NOM.	MAX.		
T1655-1	3.00	3.10	3.20	3.00	3.10	3.20		
T2055-2	3.00	3.10	3.20	3.00	3.10	3.20		
T2855-1	3.15	3.25	3.35	3.15	3.25	3.35		
T2855-2	2.60	2.70	2.80	2.60	2.70	2.80		
T3255-2	3.00	3.10	3.20	3.00	3.10	3.20		

NOTES:

- DIMENSIONING & TOLERANCING CONFORM TO ASME Y14.5M-1994.
- ALL DIMENSIONS ARE IN MILLIMETERS. ANGLES ARE IN DEGREES.
- N IS THE TOTAL NUMBER OF TERMINALS.
- THE TERMINAL #1 IDENTIFIER AND TERMINAL NUMBERING CONVENTION SHALL CONFORM TO JESD 95-1 SPP-012. DETAILS OF TERMINAL #1 IDENTIFIER ARE OPTIONAL, BUT MUST BE LOCATED WITHIN THE ZONE INDICATED. THE TERMINAL #1 IDENTIFIER MAY BE EITHER A MOLD OR MARKED FEATURE.
- DIMENSION b APPLIES TO METALLIZED TERMINAL AND IS MEASURED BETWEEN 0.25 mm AND 0.30 mm FROM TERMINAL TIP.
- ND AND NE REFER TO THE NUMBER OF TERMINALS ON EACH D AND E SIDE RESPECTIVELY.
- DEPOPULATION IS POSSIBLE IN A SYMMETRICAL FASHION.
- COPLANARITY APPLIES TO THE EXPOSED HEAT SINK SLUG AS WELL AS THE TERMINALS.
- DRAWING CONFORMS TO JEDEC MO220.
- WARPAGE SHALL NOT EXCEED 0.10 mm.

MAXIM		
<small>PROPRIETARY INFORMATION</small>		
TITLE: PACKAGE OUTLINE 16, 20, 28, 32L, QFN THIN, 5x5x0.8 mm		
APPROVAL	DOCUMENT CONTROL NO. 21-0140	REV. C 2/2

Maxim cannot assume responsibility for use of any circuitry other than circuitry entirely embodied in a Maxim product. No circuit patent licenses are implied. Maxim reserves the right to change the circuitry and specifications without notice at any time.

12 _____ **Maxim Integrated Products, 120 San Gabriel Drive, Sunnyvale, CA 94086 408-737-7600**