

## MAX40008/MAX40009

## 220ns, 12 $\mu$ A, 6-Bump WLP Comparators with Shutdown

### General Description

The MAX40008/MAX40009 are single micro-power comparators featuring low-voltage operation and rail-to-rail inputs. Their operating supply voltage range from 1.7V to 5.5V, which makes them ideal for systems running from nominal 1.8V to 5V supplies.

While only consuming 12 $\mu$ A of supply current, the MAX40008/MAX40009 achieve a 220ns propagation delay. These devices feature 0.5mV (typ) input offset voltage and internal hysteresis, ensuring clean output switching, even with slow-moving input signals.

The output stage's unique design limits supply-current surges while switching, virtually eliminating the supply glitches typical of many other comparators. The MAX40009 has a push-pull output stage, while the MAX40008 has an open-drain output stage that can be pulled beyond  $V_{DD}$  to 6V (max) above GND input. The open-drain version is ideal for level translators and bipolar to single-ended converters.

The MAX40008/MAX40009 are available in tiny 0.73mm x 1.1mm 6-bump wafer-level packages (WLPs), significantly reducing the required board area. An alternative 6-pin SOT23 package is also available. These devices are fully specified over the -40°C to +125°C automotive temperature range.

### Applications

- Mobile Communications
- Portable/Battery-Powered Systems
- Window Comparators
- Level Translators
- Threshold Detectors/ Discriminators
- IR Receivers

### Benefits and Features

- 220ns Propagation Delay
- Tiny 0.73mm x 1.1mm with 0.35mm Pitch 6-Bump WLP and SOT23 Packages Save Board Space
- Rail-to-Rail Inputs
- Low Operating Current  $\leq$  17 $\mu$ A (max) Over Temperature
- No Phase Reversal for Overdriven Inputs
- Integrated RF Immunity Filters
- Supply Voltage Range (1.7V to 5.5V) Allows Operation from 1.8V, 2.5V, 3V, and 5V Supplies
- Push-Pull (MAX40009) or Open-Drain (MAX40008) Outputs
- -40°C to +125°C Temperature Range
- Low-Power Shutdown Input Reduces Quiescent Current to 150nA

[Ordering Information](#) appears at end of data sheet.

Simplified Block Diagram

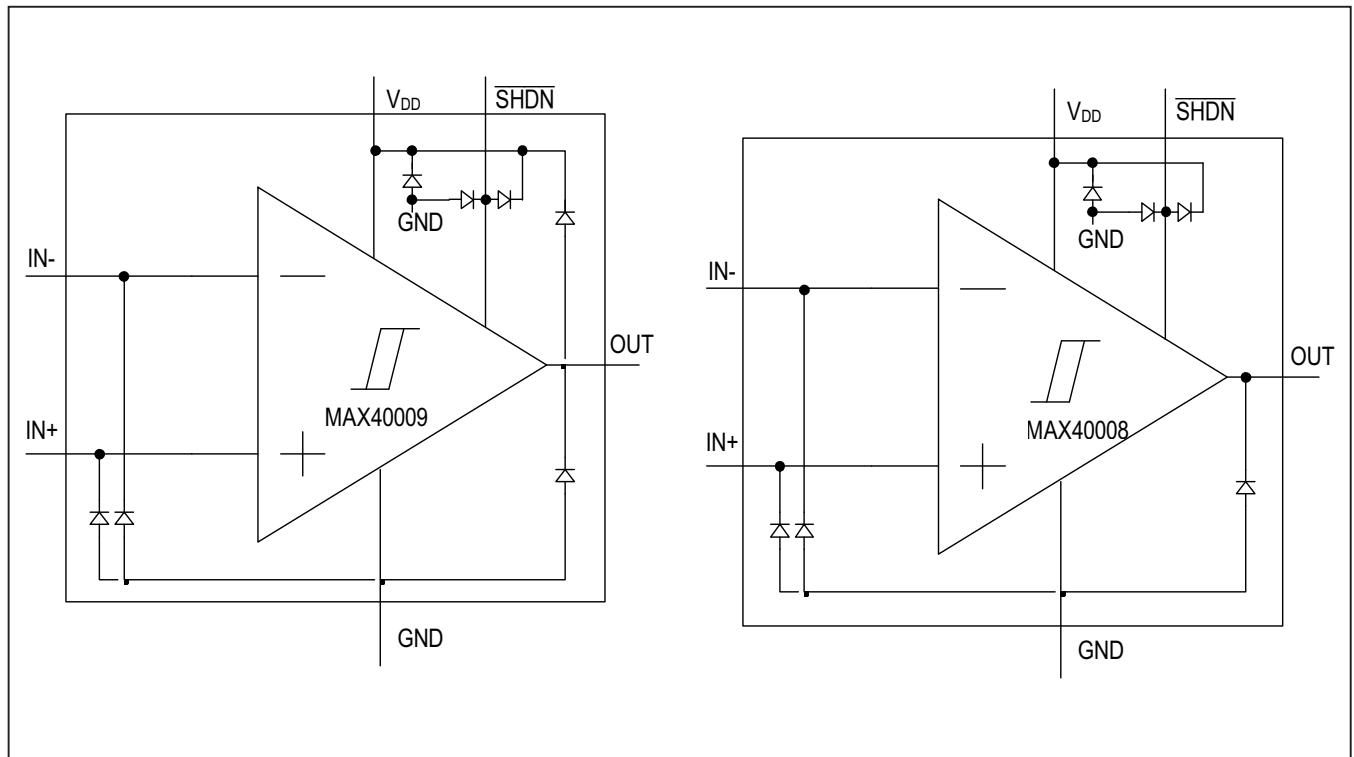

**Absolute Maximum Ratings**

V<sub>DD</sub> to GND .....-0.3V to +6V  
 IN+, IN-,  $\overline{\text{SHDN}}$  to GND .....-0.3V to +6V  
 IN+ to IN- .....±6V  
 OUT(MAX40008) to GND .....-0.3V to +6V  
 OUT(MAX40009) to GND .....-0.3V to V<sub>DD</sub> + 0.3V  
 OUT Short-Circuit to V<sub>DD</sub> or GND Duration ..... 10s  
 Continuous Current Into Any Input Pin ..... 20mA  
 Continuous Current Into/Out of Any Output Pin ..... 50mA

Maximum Power Dissipation .....  
 WLP-6, Derate 10.2mW/°C Above +70°C .....816mW  
 SOT23-6, Derate 4.3mW/°C Above +70°C .....347.8mW  
 Operating Temperature Range ..... -40°C to +125°C  
 Junction Temperature ..... +150°C  
 Storage Temperature Range ..... -65°C to +150°C  
 Lead Temperature (Soldering, 10s) ..... +300°C

*Stresses beyond those listed under "Absolute Maximum Ratings" may cause permanent damage to the device. These are stress ratings only, and functional operation of the device at these or any other conditions beyond those indicated in the operational sections of the specifications is not implied. Exposure to absolute maximum rating conditions for extended periods may affect device reliability.*

**Package Information**

**6-WLP**

PACKAGE CODE	N60D1+1
Outline Number	<a href="#">21-100086</a>
Land Pattern Number	Refer to <a href="#">Application Note 1891</a>
<b>THERMAL RESISTANCE, FOUR-LAYER BOARD:</b>	
Junction to Ambient ( $\theta_{JA}$ )	98°C/W
Junction to Case ( $\theta_{JC}$ )	

**6-SOT23**

PACKAGE CODE	U6+1
Outline Number	<a href="#">21-0058</a>
Land Pattern Number	<a href="#">90-0175</a>
<b>THERMAL RESISTANCE, FOUR-LAYER BOARD:</b>	
Junction to Ambient ( $\theta_{JA}$ )	230°C/W
Junction to Case ( $\theta_{JC}$ )	76°C/W

For the latest package outline information and land patterns (footprints), go to [www.maximintegrated.com/packages](http://www.maximintegrated.com/packages). Note that a "+", "#", or "-" in the package code indicates RoHS status only. Package drawings may show a different suffix character, but the drawing pertains to the package regardless of RoHS status.

Package thermal resistances were obtained using the method described in JEDEC specification JESD51-7, using a four-layer board. For detailed information on package thermal considerations, refer to [www.maximintegrated.com/thermal-tutorial](http://www.maximintegrated.com/thermal-tutorial).

## Electrical Characteristics

( $V_{DD} = V_{SHDN} = 3.3V$ ,  $V_{CM} = 0V$ ,  $R_{PULLUP} = 39k\Omega$  from OUT to  $V_{DD} = 3.3V$  (for MAX40008 only),  $R_{LOAD} =$  open circuit,  $C_{LOAD} = 15pF$ ,  $T_A = T_{MIN}$  to  $T_{MAX}$ . Typical values are at  $T_A = +25^\circ C$ , unless otherwise noted (Note 1))

PARAMETER	SYMBOL	CONDITIONS	MIN	TYP	MAX	UNITS
<b>POWER SUPPLY SPECIFICATIONS</b>						
Supply Voltage Range	$V_{DD}$	Guaranteed by PSRR specification	1.7		5.5	V
Supply Current	$I_{DD}$	No output or load current, output is high, $1.7V \leq V_{DD} \leq 5.5V$ , $T_A = -40^\circ C$ to $+125^\circ C$			17	$\mu A$
		No output or load current, output is high, $T_A = +25^\circ C$		12		$\mu A$
Supply Current in Shutdown Mode	$I_{DD}$	$V_{SHDN} = GND$ , $T_A = -40^\circ C$ to $+125^\circ C$			1	$\mu A$
Shutdown Input Current		$V_{SHDN} = V_{DD}$			1	$\mu A$
		$V_{SHDN} = GND$	1			
Shutdown Input Voltage Low		Shutdown logic-level low			0.55	V
Shutdown Input Voltage High		Shutdown logic-level high	1.3			V
Power-Up Time				50		$\mu s$
<b>COMPARATOR</b>						
Input Common Mode Range	$V_{CM}$	Guaranteed by CMRR specification, $T_A = +25^\circ C$	-0.2		$V_{DD} + 0.2$	V
		Guaranteed by CMRR specification $T_A = -40^\circ C$ to $125^\circ C$	0		$V_{DD}$	
Input Offset Voltage (Note 2)		$V_{CM} = 1.65V = V_{DD}/2$ , $T_A = -40^\circ C$ to $+125^\circ C$		$\pm 0.5$	$\pm 5$	mV
Common Mode Rejection Ratio	CMRR		52	70		dB
Input Hysteresis (Note 3)	$V_{HYS}$			3		mV
Input Bias Current	$I_B$	Over the common mode input range ( $V_{CM}$ ), $T_A = -40^\circ C$ to $+125^\circ C$		20	140	nA
Input Capacitance		Either input, over entire $V_{CM}$ range		1		pF
Power Supply Rejection Ratio		DC, over the entire common mode input range ( $V_{CM}$ ), measured at $V_{CM} = 0V$ and $V_{CM} = V_{DD}$	60			dB
Output Voltage Swing Low	$V_{OL}$	Sinking 8mA output current, $V_{(OUT-GND)}$ at $V_{DD} = 3.3V$			0.4	V
		Sinking 1.6mA output current, $V_{(OUT-GND)}$ at $V_{DD} = 1.7V$			0.4	

**Electrical Characteristics (continued)**

( $V_{DD} = V_{SHDN} = 3.3V$ ,  $V_{CM} = 0V$ ,  $R_{PULLUP} = 39k\Omega$  from OUT to  $V_{DD} = 3.3V$  (for MAX40008 only),  $R_{LOAD} =$  open circuit,  $C_{LOAD} = 15pF$ ,  $T_A = T_{MIN}$  to  $T_{MAX}$ . Typical values are at  $T_A = +25^\circ C$ , unless otherwise noted (Note 1))

PARAMETER	SYMBOL	CONDITIONS	MIN	TYP	MAX	UNITS
Output Voltage Swing High	$V_{OH}$	Sourcing 1.6mA output current, $V_{(DD-OUT)}$ at $V_{DD} = 1.7V$			0.6	V
		Sourcing 8mA output current, $V_{(DD-OUT)}$ at $V_{DD} = 3.3V$			0.6	
Propagation Delay (Note 4)	$t_{PD}$	100mV overdrive, output L->H, MAX40009		220		ns
		100mV overdrive, output L->H, MAX40008; $R_{PULLUP} = 39k\Omega$		650		
		100mV overdrive, output H->L, MAX40008/MAX40009		235		
		20mV overdrive, output L->H, MAX40009		245		
		20mV overdrive, output L->H, MAX40008; $R_{PULLUP} = 39k\Omega$		850		
		20mV overdrive, output H->L, MAX40008/MAX40009		340		
Rise Time	$t_R$	MAX40009, 25% to 75% output swing		1.7		ns
Fall Time	$t_F$	MAX40008/MAX40009: 75% to 25% output swing		1.4		ns

**Note 1:** All specifications are 100% production tested at  $T_A = +25^\circ C$ . Specification limits over temperature ( $T_A = T_{MIN}$  to  $T_{MAX}$ ) are guaranteed by design, not production tested.

**Note 2:** Input offset voltage;  $V_{OS}$  is defined as the center of the hysteresis band or average of the threshold trip points.

**Note 3:** The hysteresis-related trip points are defined as the edges of the hysteresis band, measured with respect to the center of the band (i.e.,  $V_{OS}$ ) (Figure 1).

**Note 4:** Propagation Delay measurement is from 20% of the input to 80% of the output.

Typical Operating Characteristics

( $V_{DD} = V_{SHDN} = 3.3V$ ,  $V_{CM} = 0V$ ,  $R_{PULLUP} = 39k\Omega$  from OUT to  $V_{DD} = 3.3V$  (for MAX40008 only),  $R_{LOAD} =$  open circuit,  $C_{LOAD} = 15pF$ ,  $T_A = T_{MIN}$  to  $T_{MAX}$ . Typical values are at  $T_A = +25^\circ C$ , unless otherwise noted (Note 1))

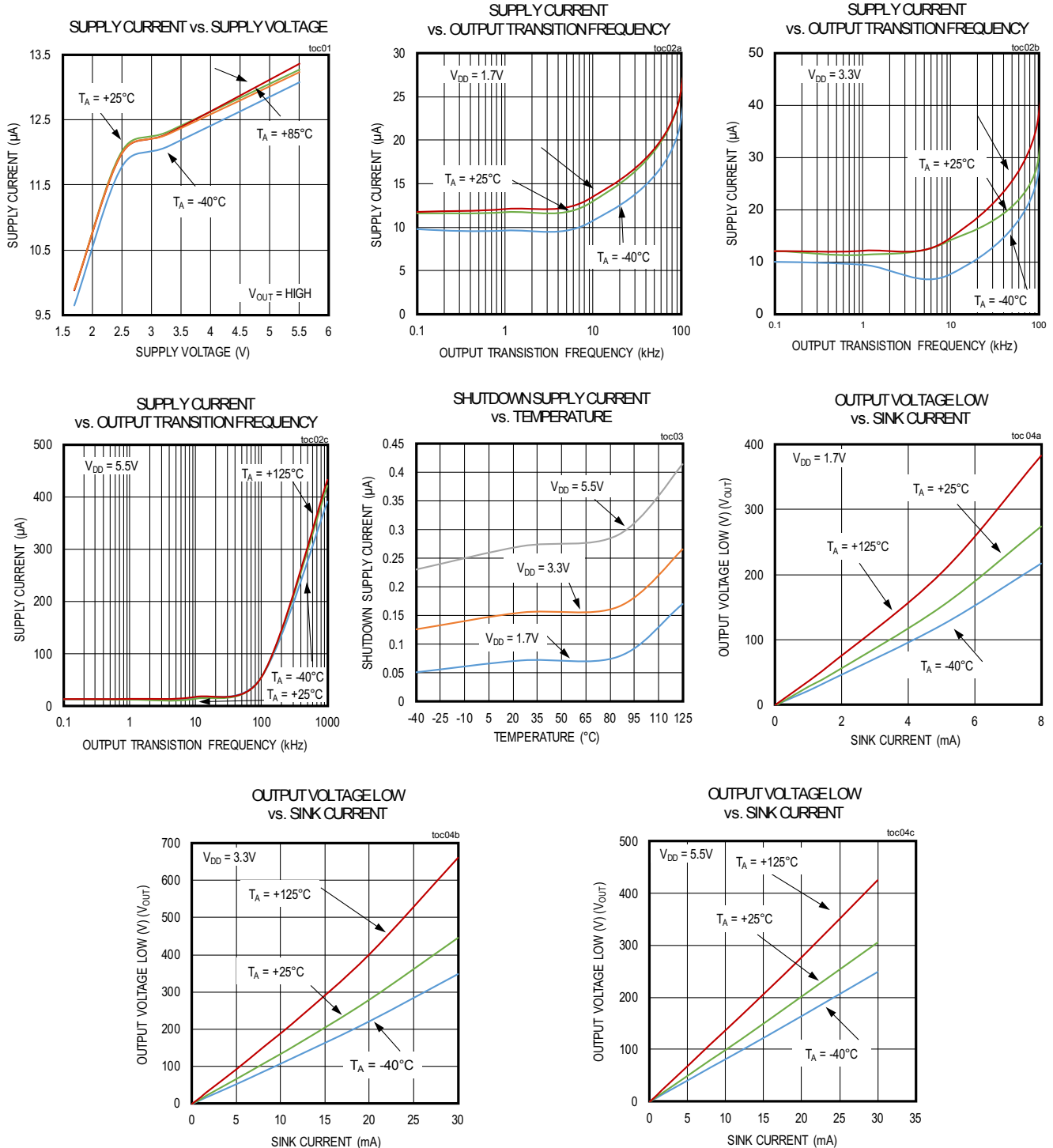

Typical Operating Characteristics (continued)

( $V_{DD} = V_{SHDN} = 3.3V$ ,  $V_{CM} = 0V$ ,  $R_{PULLUP} = 39k\Omega$  from OUT to  $V_{DD} = 3.3V$  (for MAX40008 only),  $R_{LOAD} =$  open circuit,  $C_{LOAD} = 15pF$ ,  $T_A = T_{MIN}$  to  $T_{MAX}$ . Typical values are at  $T_A = +25^\circ C$ , unless otherwise noted (Note 1))

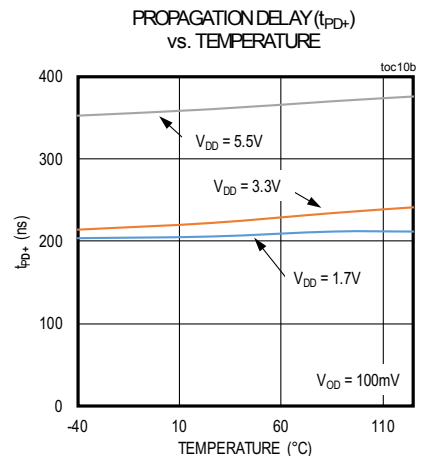
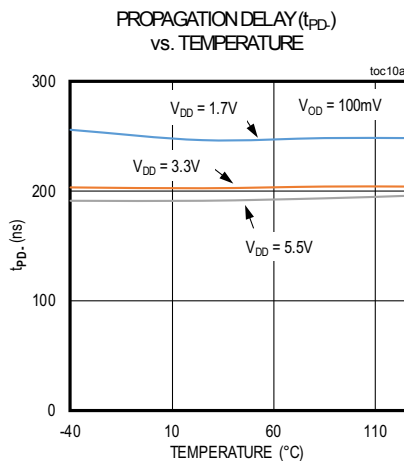
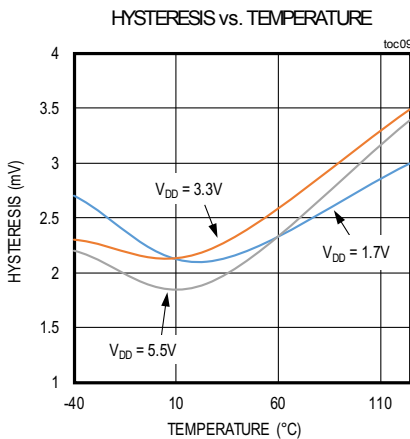
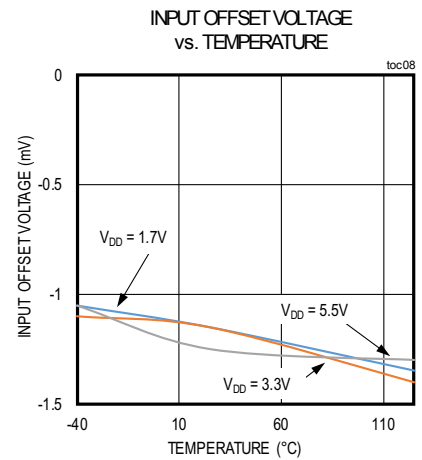
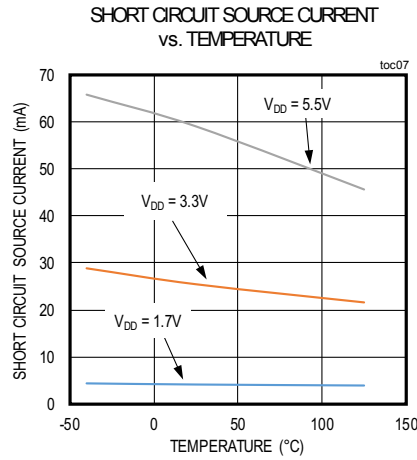
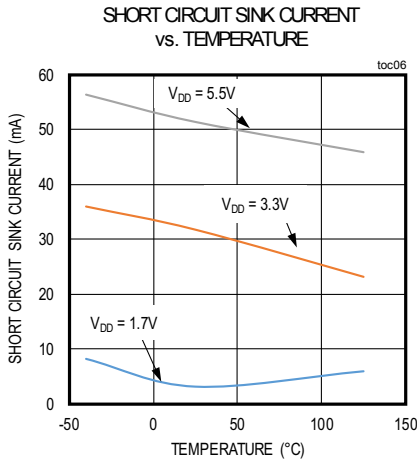
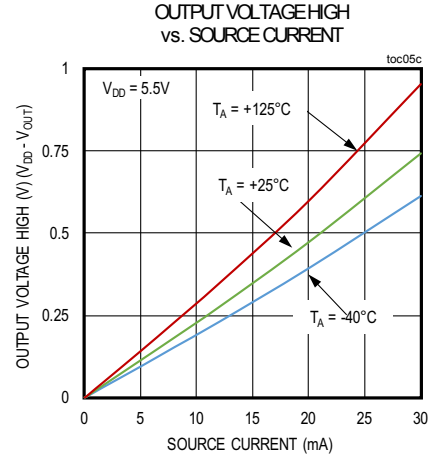
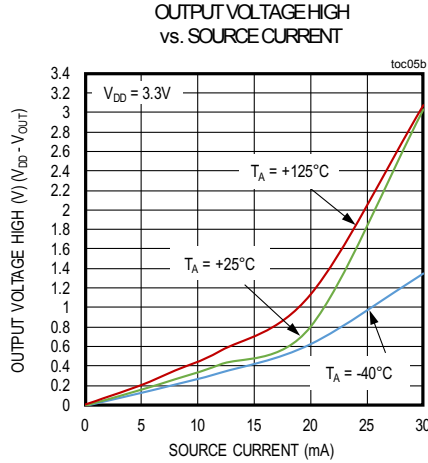
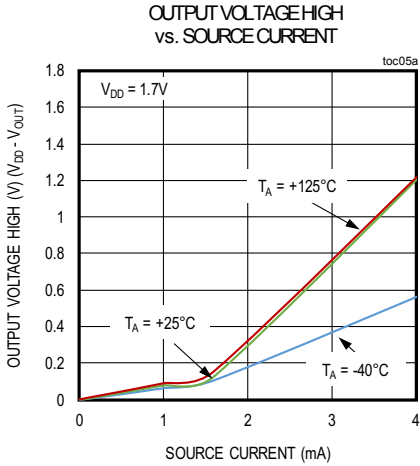

Typical Operating Characteristics (continued)

( $V_{DD} = V_{SHDN} = 3.3V$ ,  $V_{CM} = 0V$ ,  $R_{PULLUP} = 39k\Omega$  from OUT to  $V_{DD} = 3.3V$  (for MAX40008 only),  $R_{LOAD} =$  open circuit,  $C_{LOAD} = 15pF$ ,  $T_A = T_{MIN}$  to  $T_{MAX}$ . Typical values are at  $T_A = +25^\circ C$ , unless otherwise noted (Note 1))

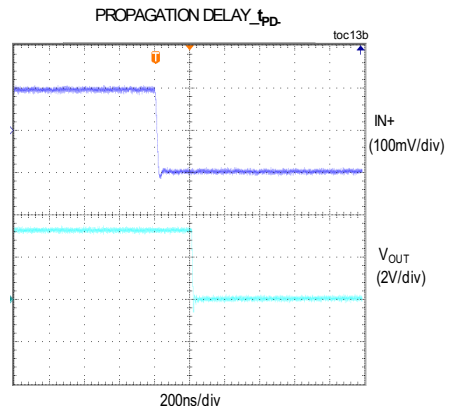
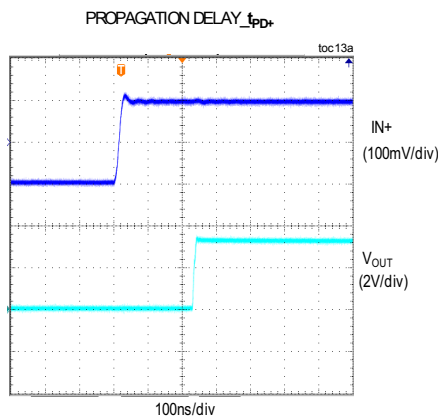
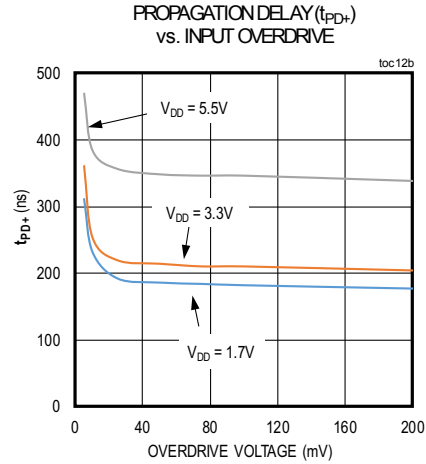
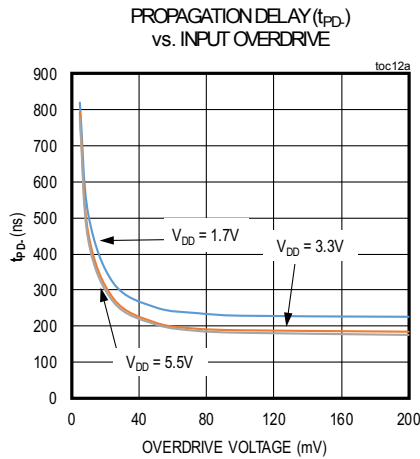
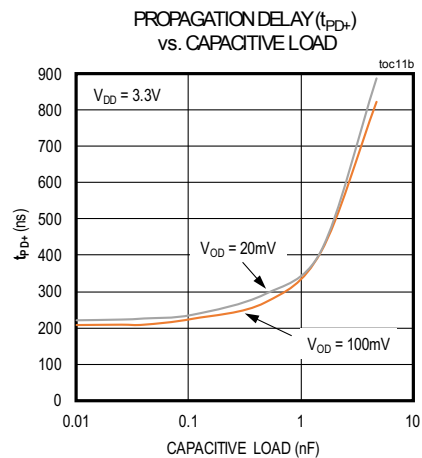
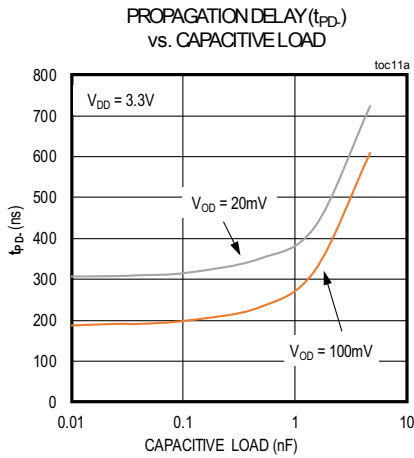



**Typical Operating Characteristics (continued)**

( $V_{DD} = V_{SHDN} = 3.3V$ ,  $V_{CM} = 0V$ ,  $R_{PULLUP} = 39k\Omega$  from OUT to  $V_{DD} = 3.3V$  (for MAX40008 only),  $R_{LOAD} =$  open circuit,  $C_{LOAD} = 15pF$ ,  $T_A = T_{MIN}$  to  $T_{MAX}$ . Typical values are at  $T_A = +25^\circ C$ , unless otherwise noted (Note 1))

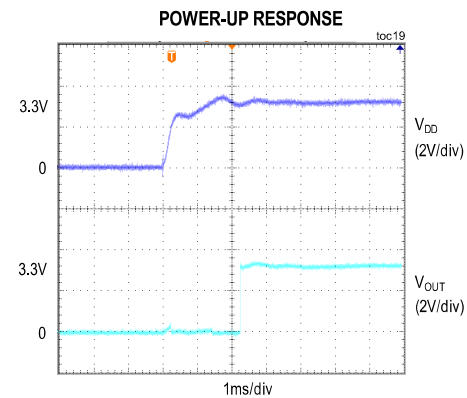
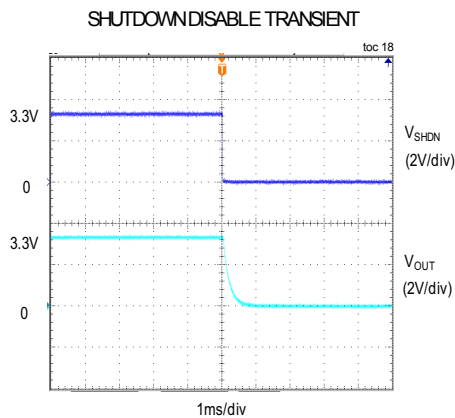
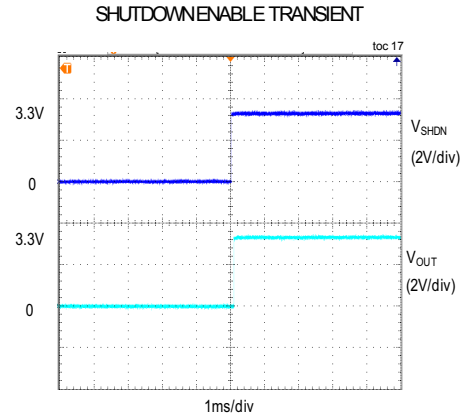
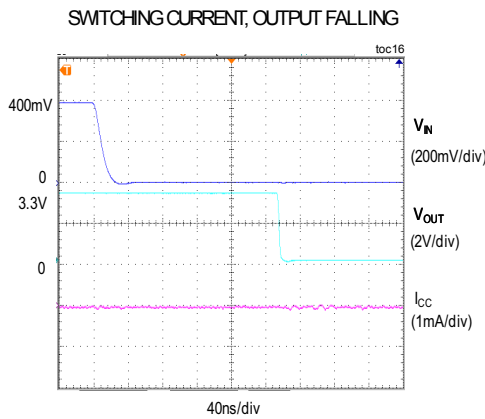
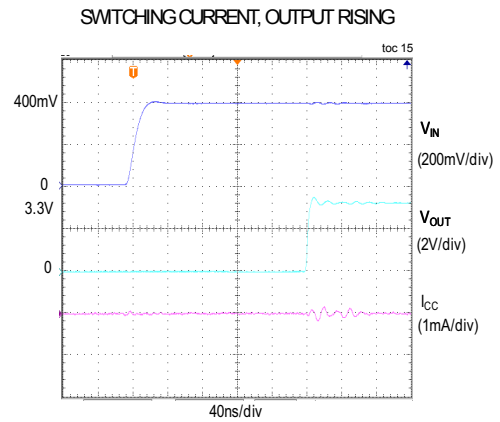
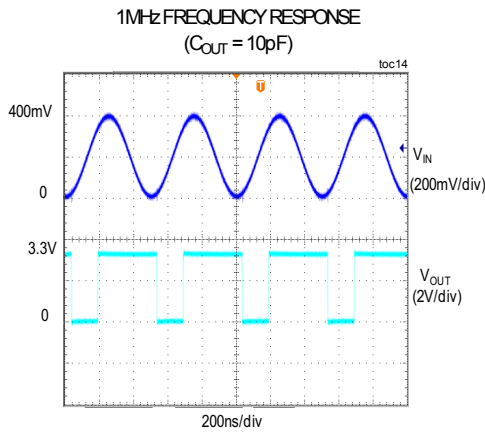

Pin Configuration

MAX40008/MAX40009 (6 WLP)

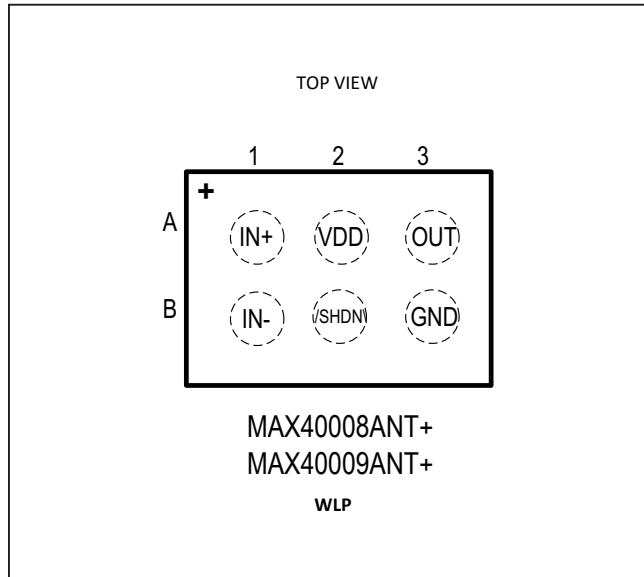

MAX40008/MAX40009 (6 SOT23)

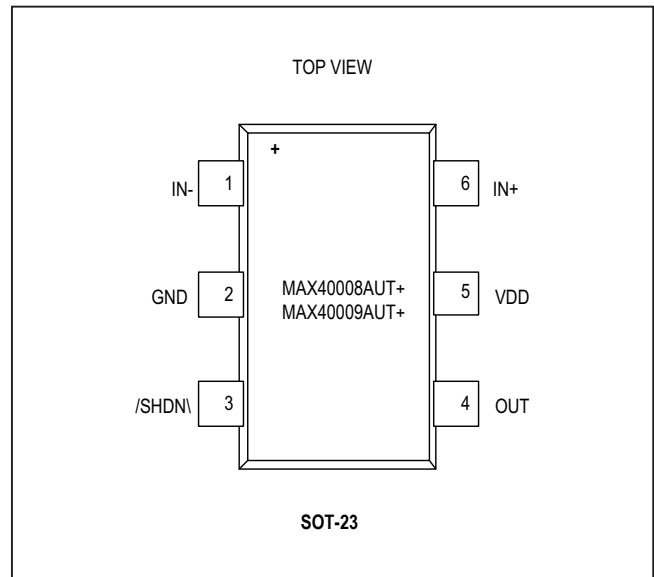

Pin Description

PIN		NAME	FUNCTION
MAX40008/ MAX40009 (6 WLP)	MAX40008/ MAX40009 (6-SOT23)		
A1	6	IN+	Non-Inverting Input of the Comparator.
A2	5	V <sub>DD</sub>	Positive Supply Voltage Input. Bypass with a 0.1µF capacitor to GND as close to the device's supply input as possible.
B1	1	IN-	Inverting Input of the Comparator.
A3	4	OUT	Open-Drain Output (MAX40008) or Push-Pull Output (MAX40009). For open-drain version, connect a 39kΩ pullup resistor from OUT to any pullup voltage up to 5.5V.
B2	3	$\overline{\text{SHDN}}$	Shutdown Input. Active-low input. The device enters into shutdown when SHDN input is low. The device is active when SHDN input is high.
B3	2	GND	Ground/Signal and Power Return.

## Detailed Description

The MAX40008/MAX40009 are single, low-power, low-voltage comparators with shutdown. They have an operating supply voltage range between 1.7V and 5.5V, while consuming only 12 $\mu$ A of supply current. Their common-mode input voltage range extends 200mV beyond each rail. Internal hysteresis ensures clean output switching, even with slow-moving input signals. Large internal output drivers allow rail-to-rail output swing with up to 8mA loads.

The output stage employs a unique design that minimizes supply current surges while switching, virtually eliminating the supply glitches typical of many other comparators. The MAX40008 has an open-drain output that can be pulled beyond  $V_{DD}$  to an absolute maximum of 6V above GND input.

## Applications Information

### Internal Hysteresis

Many comparators oscillate in the linear region of operation because of noise or undesired parasitic feedback. This tends to occur when the voltage on one input is equal to, or very close to, the voltage on the other input. The MAX40008/MAX40009 have internal 3mV hysteresis to counter parasitic effects and noise.

The hysteresis in a comparator creates two trip points: one for the upper threshold ( $V_{TRIP+}$ ) and one for the lower threshold ( $V_{TRIP-}$ ) for voltage transitions on the input signal (Figure 1). The difference between the trip points is the hysteresis band ( $V_{HYST}$ ). When the comparator's input voltages are equal, the hysteresis effectively causes one comparator input to move quickly past the other, thus taking the input out of the region where oscillation occurs. Figure 1 illustrates the case in which  $IN-$  has a fixed voltage applied, and  $IN+$  is varied. If the inputs were reversed, the figure would be the same, except with an inverted output.

### Component Selection

When employing an additional external hysteresis, the highest impedance circuits should be used wherever possible. The offset error due to input bias current is proportional to the total impedance seen at the input. For example, selecting components for Figure 2, with a target of 50mV hysteresis, a 5V supply, and choosing an  $R_F$  of 10M $\Omega$  gives  $R_G$  as 100k $\Omega$ . The total impedance seen at  $IN+$  is, therefore, 10M $\Omega$  || 100k $\Omega$ , or 99k $\Omega$ . The input bias current of MAX40008/MAX40009 is 20nA. Therefore, the error due to source impedance is less than 2000 $\mu$ V.

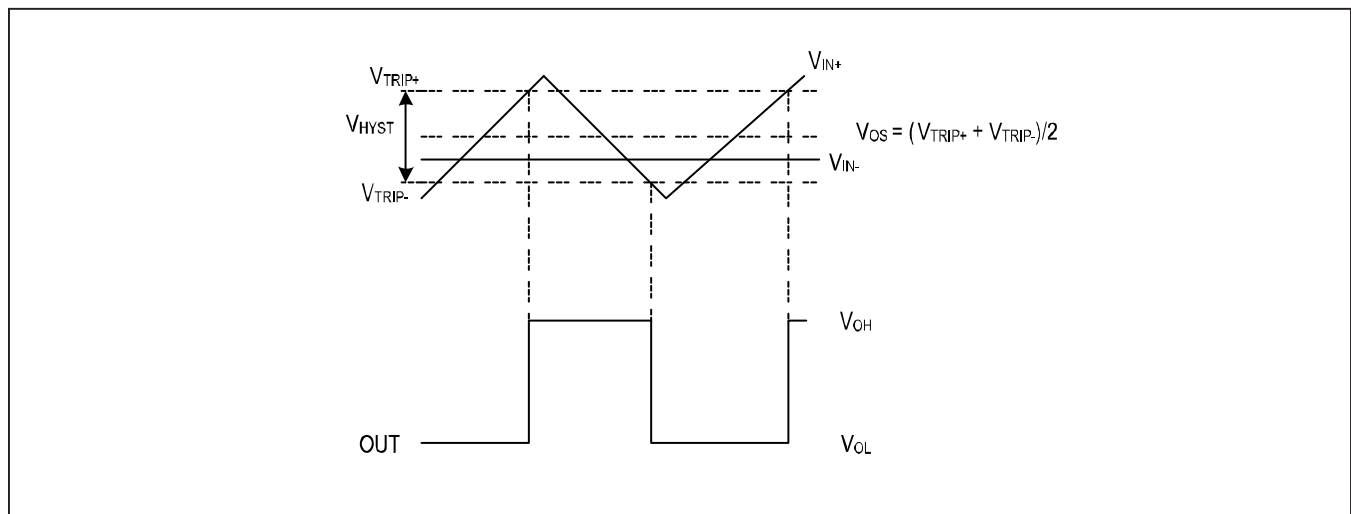

Figure 1. Hysteresis Band

**Board Layout and Bypassing**

Use 100nF bypass capacitors close to the device’s supply inputs when supply impedance is high, supply leads are long, or excessive noise is expected on the supply lines. Minimize signal trace lengths to reduce stray capacitance. A ground plane and surface-mount components are recommended.

**Data Recovery**

Figure 3 shows a time averaging of the input signal for data recovery. Digital data is often embedded into a bandwidth and amplitude-limited analog path. Recovering the data can be difficult. A simple circuit in Figure 3 compares the input signal to a time-averaged version of itself. This self-biases the threshold voltage to the average input voltage for optimal noise margin. Even severe phase distortion

is eliminated from the digital output signal. Be sure to choose R1 and C1 so that:

$$f_{CAR} \gg 1/(2\pi R1C1)$$

$f_{CAR}$  is the fundamental frequency of the input digital data stream.

**Logic Level Translator**

The *Typical Application Circuit* shows an application that converts 3.3V logic to 1.8V logic levels. The MAX40008 is powered by the +3.3V supply voltage to  $V_{DD}$ , and the pullup resistor for the MAX40008’s open-drain output is connected to the +1.8V supply voltage. This configuration allows the full 3.3V logic swing without creating overvoltage on the 1.8V logic inputs. For 1.8V to 3.3V logic-level translations, simply connect the +1.8V supply voltage to  $V_{DD}$  and the +3.3V supply voltage to the pullup resistor.

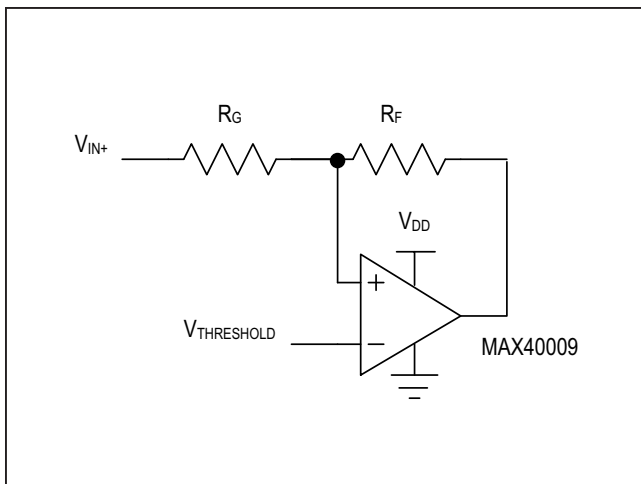

Figure 2. Additional External Hysteresis on MAX40009

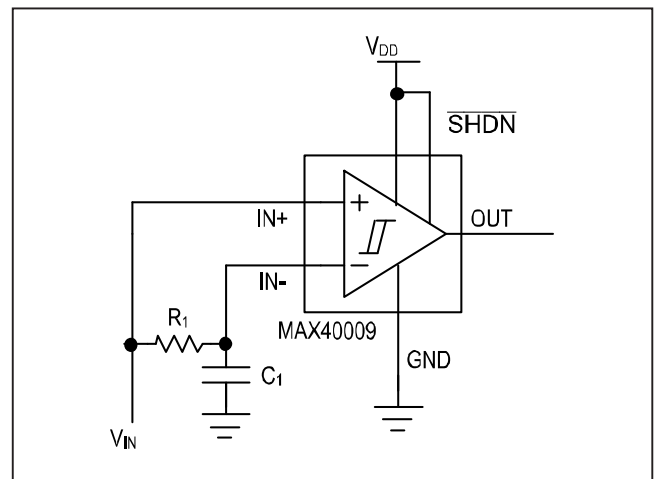
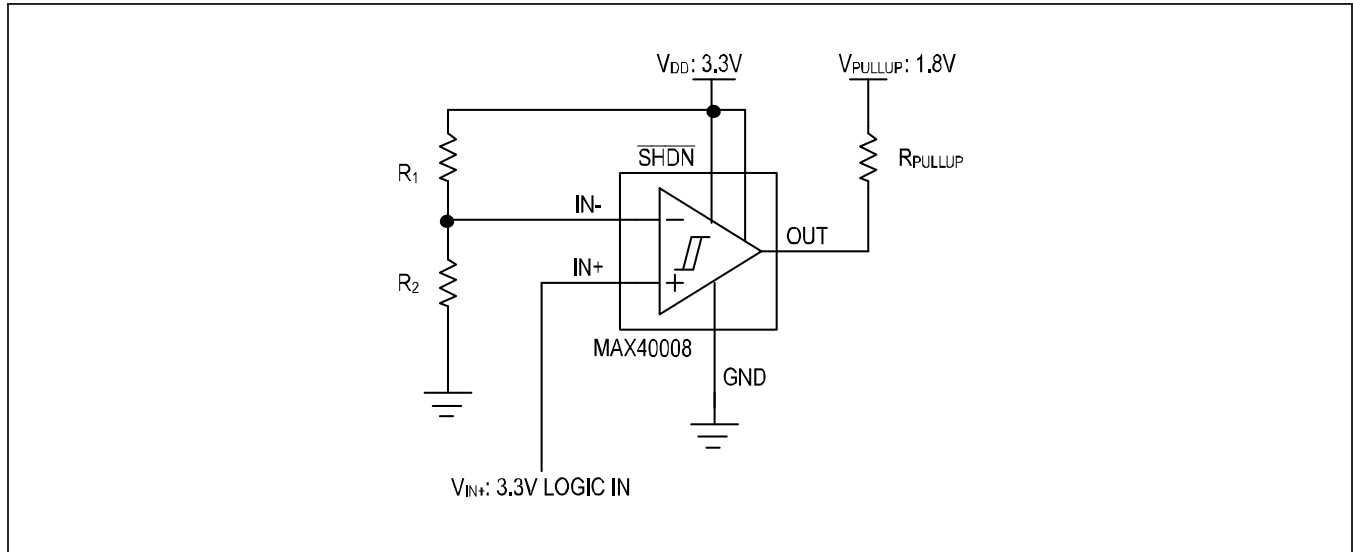

Figure 3. Time Averaging of the Input Signal for Data Recovery

**Typical Application Circuit**

**Logic Level Translator**



**Ordering Information**

PART NUMBER	TEMP RANGE	PIN-PACKAGE	TOP MARK
MAX40008ANT+T	-40°C to +125°C	6 WLP	+3
MAX40009ANT+T	-40°C to +125°C	6 WLP	+4
MAX40008AUT+T*	-40°C to +125°C	6 SOT23	+ACUW
MAX40009AUT+T*	-40°C to +125°C	6 SOT23	+ACUX

\* Denotes a lead (Pb)-free/RoHS-compliant package.

T = Tape and reel.

Future Product—Contact factory for availability.

## Revision History

REVISION NUMBER	REVISION DATE	DESCRIPTION	PAGES CHANGED
0	12/16	Initial release	—
1	5/17	Removed future product asterisk from MAX40008ANT+T part number	13

For pricing, delivery, and ordering information, please contact Maxim Direct at 1-888-629-4642, or visit Maxim Integrated's website at [www.maximintegrated.com](http://www.maximintegrated.com).

*Maxim Integrated cannot assume responsibility for use of any circuitry other than circuitry entirely embodied in a Maxim Integrated product. No circuit patent licenses are implied. Maxim Integrated reserves the right to change the circuitry and specifications without notice at any time. The parametric values (min and max limits) shown in the Electrical Characteristics table are guaranteed. Other parametric values quoted in this data sheet are provided for guidance.*