

## CLP0424/428 Open Frame Power Supply

90 - 265Vac input; 24/28Vdc output; 450W Output Power



### Applications

- Industrial equipment
- Telecommunications equipment
- Robotics
- 3D Printers

### Description

In a small 3 x 5 inch footprint, the 24/28Vdc single-output CLP0424 open frame power supply delivers greater than 91 percent typical power efficiency and full load output at 50°C and 1m/s airflow. Protection features include output overcurrent (OCP), overvoltage (OVP), and overtemperature (OTP).

### Features

- Compact size 76.2 mm x 127 mm x 35 mm (3 in x 5 in x 1.38 in) with density of 21.4 W/in<sup>3</sup>
- Universal AC Input Range (90 - 265VAC)
- Output voltage of 24/28V (adjustable ±5%)
- Standby output of 5V @ 1A
- Standby input power consumption < 0.5W
- Maximum output current of 18.8A @ 24Vout, 16.1A @ 28V out (450W)
- High efficiency (>92% at full load, 230VAC in)
- Full load capability at 50°C and 1m/s airflow with derating at higher temperatures or lower airflows
- Capable of ≥340W out in sealed enclosure applications with enclosure ambient at 55°C
- Output overcurrent protection (non-latching)
- Overtemperature protection
- Output overvoltage protection
- Minimum of 11ms of holdup time at 450W out
- Parallelable with output current sharing
- Active power factor corrected input
- Conducted EMI - meets CISPR22 (EN55022) and FCC Class B requirements
- Meets IEC61000-4-5, Level 4 (2kV/4kV)
- Compliant to RoHS EU Directive 2002/95/EC
- UL and cUL approved to UL/CSA60950-1, TUV (EN60950-1), CE Mark (for LVD) and CB Report available
- ISO\*\* 9001 and ISO 14001 certified manufacturing facilities

\* UL is a registered trademark of Underwriters Laboratories, Inc.

† CSA is a registered trademark of Canadian Standards Association.

‡ VDE is a trademark of Verband Deutscher Elektrotechniker e.V.

\*\* ISO is a registered trademark of the International Organization of Standards

## CLP0424/428 Open Frame Power Supply

90 - 265Vac input; 24/28Vdc output; 450W Output Power

### Absolute Maximum Ratings

Stresses over the absolute maximum ratings can cause permanent damage to the device. These are absolute stress ratings only; functional operation of the device is not implied at these or any other conditions in excess of those given in the operations sections of the data sheet. Exposure to absolute maximum ratings for extended periods can adversely affect the device reliability.

Parameter	Device	Min	Max	Unit
Input Voltage - Continuous	All	90	265	Vac
For up to 10 seconds	All	90	275	Vac
Operating Ambient Temperature see (Thermal Considerations section) -40C Start Vout Stable after 20 minutes warm up period with 50% loading All specifications met at -10C or above	All	-40	85	°C
Storage Temperature	All	-40	85	°C
Humidity (non-condensing)	All	5	95	%
Altitude	All		5000	m
Isolation Voltage - Input to output	All		3000	Vac
Input to safety ground	All		1500	Vac
Outputs to safety ground	All		50	Vac

### Electrical Specifications

Parameter	Device	Min	Typ	Max	Unit
Operating Input Voltage	All	90	115/230	265	Vac
Input Source Frequency	All	0	50/60	63	Hz
Input Current ( $V_{IN} = 90\text{Vac}$ )	All			6	$A_{RMS}$
Input Power Factor (230Vac, Full Load)	All	0.95			
Inrush Transient Current ( $V_{IN} = 265\text{Vac}$ , $T_{amb} = 25^{\circ}\text{C}$ )	All			60	A Peak
Leakage Current to earth ground ( $V_{IN} = 265\text{Vac}$ )	All			3.5	mA
Output Voltage Setpoint	24V out Version		24		Vdc
	28V out version		28		Vdc
Output Voltage Tolerance (due to set point, temperature variations, load and line regulation)	All	-2		2	%
Output Voltage Adjustment Range	24V out Version	22.8	24	25.2	Vdc
	28V out version	26.6	28	29.4	Vdc
Output Remote Sense Range	All			1	Vdc
Output Load Regulation	All			1	%Vout
Output Line Regulation	All	-0.5		0.5	%Vout
Output Ripple and Noise - measured with 0.1 $\mu\text{F}$ ceramic capacitor in parallel with 470 $\mu\text{F}$ electrolytic capacitor (p-p with 20MHz Bandwidth)	All			350	mV p-p
Dynamic Load Response - 50% to 100% load transient, 1A/ $\mu\text{s}$ slew rate	All			5%	%
Output voltage deviation	All			500	$\mu\text{s}$
Settling Time	All				
Output Current	24V out version	0		18.75	Adc
	28V out version	0		16.1	Adc
Output Current Limit Inception	All	110		145	% $I_{O,max}$
Maximum Output Capacitance	All			5000	$\mu\text{F}$
Standby Output Voltage	All		5		Vdc
Standby Output Current	All			1	Adc
Efficiency: $V_{IN} = 230\text{Vac}$ , 20% load	All	88.0			%
50% load	All	92.0			%
100% load	All	88.0			%
$V_{IN} = 115\text{Vac}$ , 20% load	All	87.0			%
50% load	All	90.0			%
100% load	All	87.0			%

## CLP0424/428 Open Frame Power Supply

90 - 265Vac input; 24/28Vdc output; 450W Output Power

Parameter	Device	Min	Typ	Max	Unit
Holdup Time <sup>1</sup> - $V_{IN} = 115\text{Vac}$ , 450W load	All	11			ms
$V_{IN} = 230\text{Vac}$ , 450W load	All	11			ms
Input Power Consumption in Standby Mode (main output off, 0.2W load on standby output) AC input Version only	All			0.5	W

### General Specifications

Parameter	Device	Symbol	Typ.	Unit
Calculated Reliability based on Telcordia SR-332 Issue 2: Method 1 Case 3 ( $V_{IN}=230\text{Vac}$ , $I_o = 18.75\text{A}$ , $T_A = 40^\circ\text{C}$ , airflow 200LFM, 90% confidence)	All	MTBF	>750,000	Hours
Weight	All		389 13.72	g oz.

### Feature Specifications

Parameter	Device	Min	Typ	Max	Unit
On/Off Signal Interface - signal referenced to GND	All				
Logic Low (Power Supply ON)	All				
Input Low Current	All			7	mA
Input Low Voltage	All			1	V
Logic High (Power Supply OFF)	All				
Input High Current	All			600	$\mu\text{A}$
Input Voltage	All	2.5		5.5	V
Delay from ON/OFF being enabled to start of output voltage rise	All			200	ms
Output Voltage Rise Time (from 10 to 90% of final value)	All		20		ms
Delay from Input being applied to all outputs being in regulation	All			1000	ms
Output Overvoltage Protection	24V out version	27.6		32	Vdc
	28V out version	32.2		37.3	Vdc
Input Under voltage lockout <sup>2</sup>					
Turn-on Threshold (100% load)	All			90	Vac
Turn-off Threshold (100% load)	All			88	Vac
DC OK - open collector, High when output available					
Sink Current	All			4	mA
Maximum Collector Voltage	All			12	V

<sup>1</sup> Holdup time may be lower at cold temperatures

<sup>2</sup> Under voltage lockout threshold may vary with output load current level - decreasing as load goes lower

## CLP0424/428 Open Frame Power Supply

90 - 265Vac input; 24/28Vdc output; 450W Output Power

### Environmental Specifications

Parameter	Device	Specification/Test
Radiated Emissions <sup>3</sup>	All	CISPR22 Class B with 3dB margin
Conducted Emissions	All	CISPR22 Class B with 6dB margin
ESD	All	IEC61000-4-2, Level 3
Radiated Susceptibility <sup>4</sup>	All	IEC61000-4-3, Level 3
Electrical Fast Transient Common Mode	All	IEC61000-4-4, Level 3
Surge Immunity (note- overshoot or undershoot may be observed during an event > 5% for 20 us application dependent)	All	IEC61000-4-5, Level 4
Conducted RF Immunity	All	IEC61000-4-6, Level 3
Input Voltage Dips	All	Output stays within regulation for either ½ cycle interruption or 25% dip from nominal line for 1 second
Input Harmonics	All	IEC61000-3-2
Shock and Vibration	All	Per IPC-9592B, Class II

### Safety Specifications

Parameter	Device	Specification
Dielectric Withstand Voltage (between input and output)	All	Minimum of 4,250Vdc for 1 minute
Insulation Resistance (between input and output)	All	Minimum of 5 MΩ
Safety Standards	All	Class 1, IEC60950, EN60950, with the following deviations: Nemko, UL 60950 (Recognized Component), cUL (Canadian Approval by UL)

<sup>3</sup> Shall meet when tested in a suitable enclosure

<sup>4</sup> Shall meet when tested in a suitable enclosure

CLP0424/428 Open Frame Power Supply  
 90 - 265Vac input; 24/28Vdc output; 450W Output Power

Characteristic Curves

The following figures provide typical characteristics for the CLP0424 power supply

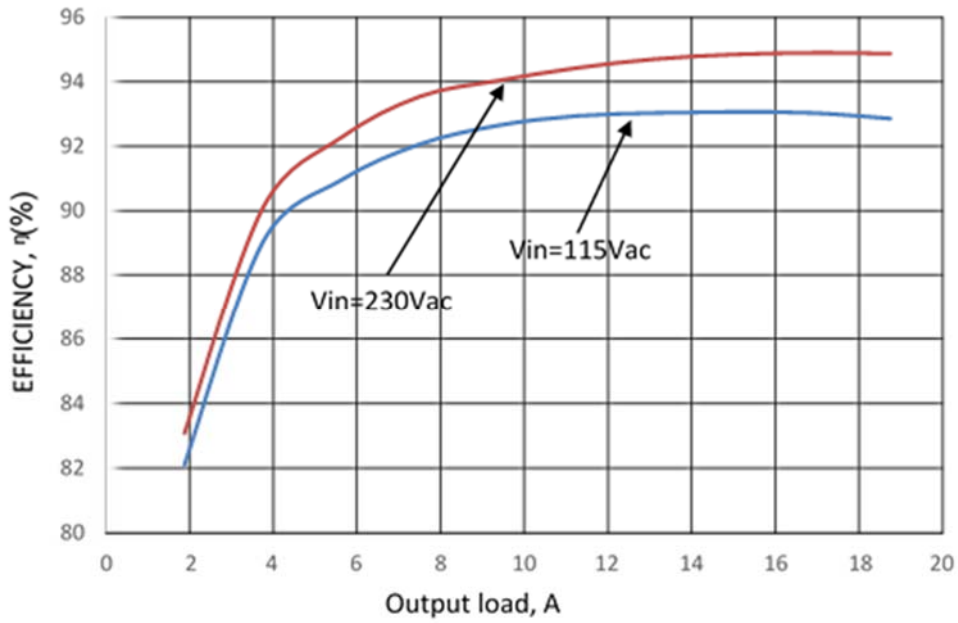

Figure 1. Power Supply Efficiency versus Output Current

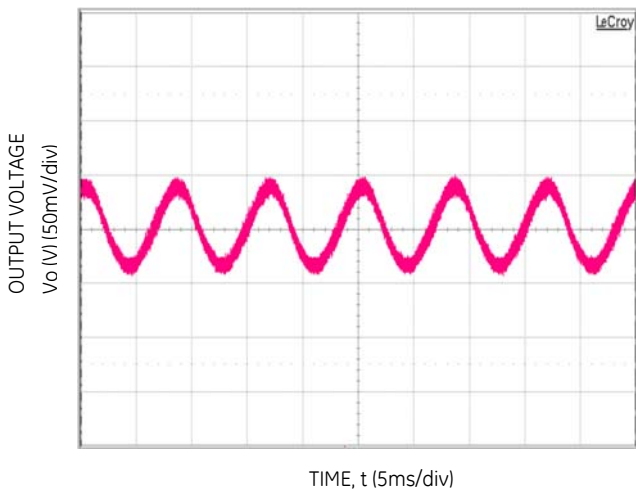

Figure 2. Typical output ripple and noise ( $V_{IN} = 230V_{ac}$  100% load).

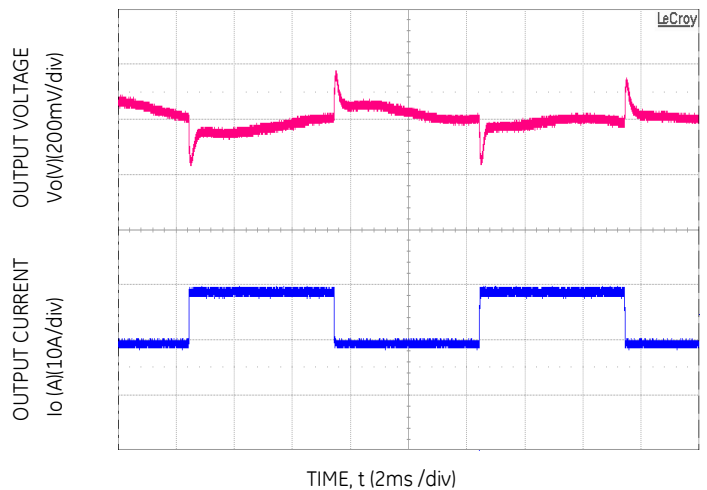

Figure 3. Transient Response to Dynamic Load change from 50% to 100% at  $V_{in} = 230V_{ac}$ .

# CLP0424/428 Open Frame Power Supply

90 - 265Vac input; 24/28Vdc output; 450W Output Power

## Characteristic Curves (cont.)

The following figures provide typical characteristics for the CLP0424 power supply

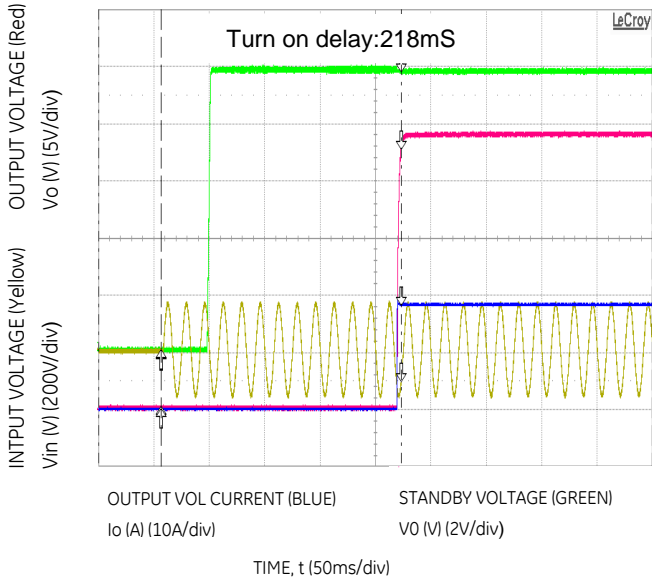

Figure 4. Typical Start-up ( $V_{IN} = 115\text{Vac}$ , Full Load).

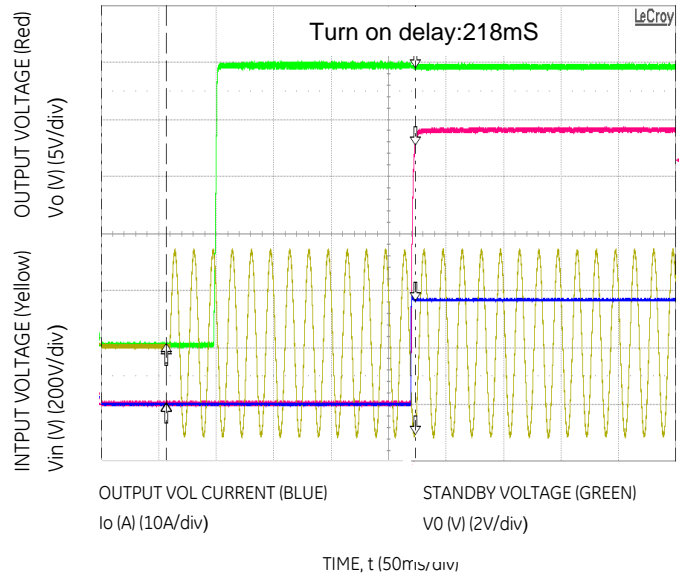

Figure 5. Typical Start-up ( $V_{IN} = 230\text{Vac}$ , Full Load).

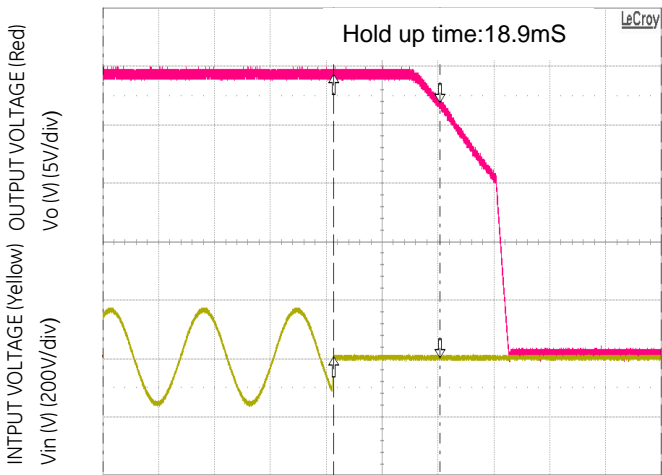

Figure 6. Typical Hold-up waveforms ( $V_{IN} = 115\text{V}$ , 100% Load)

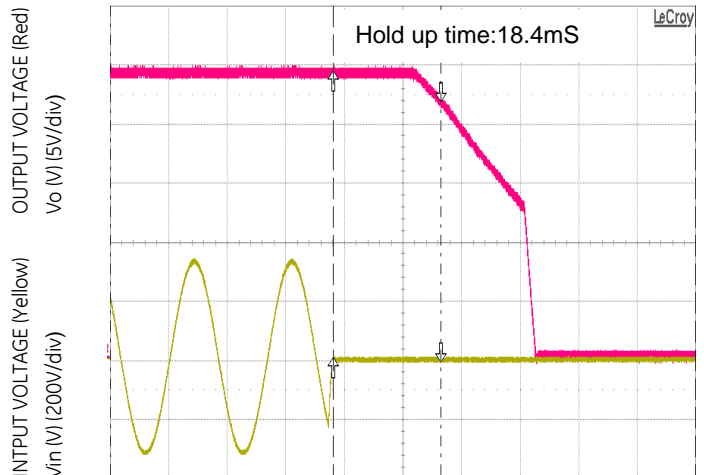
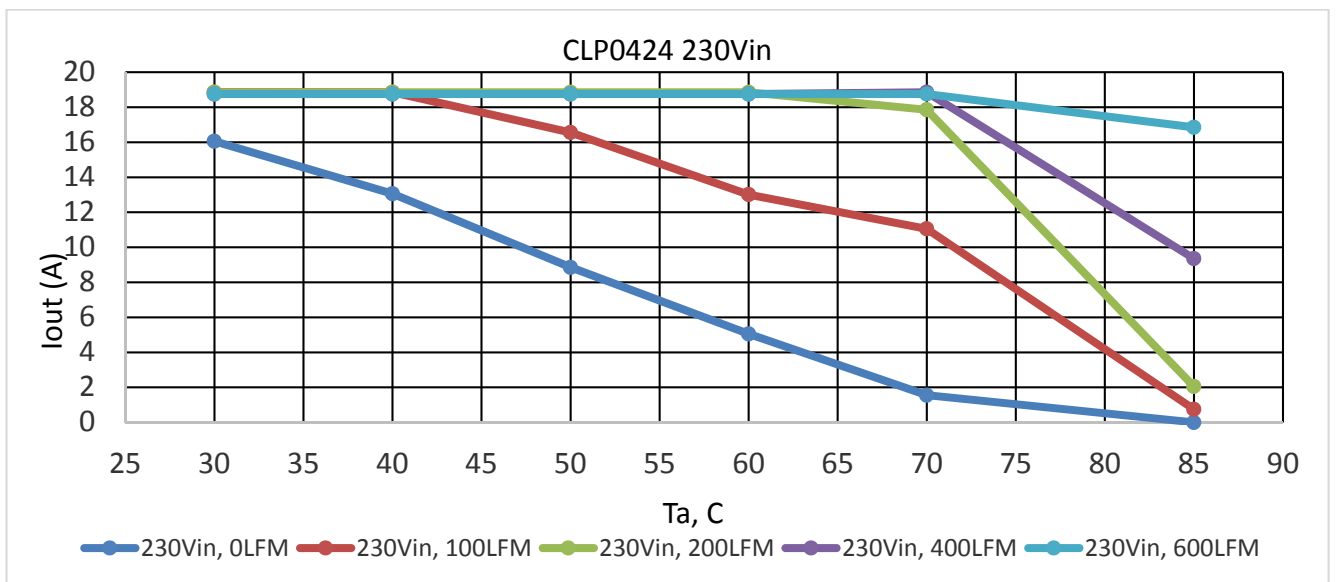
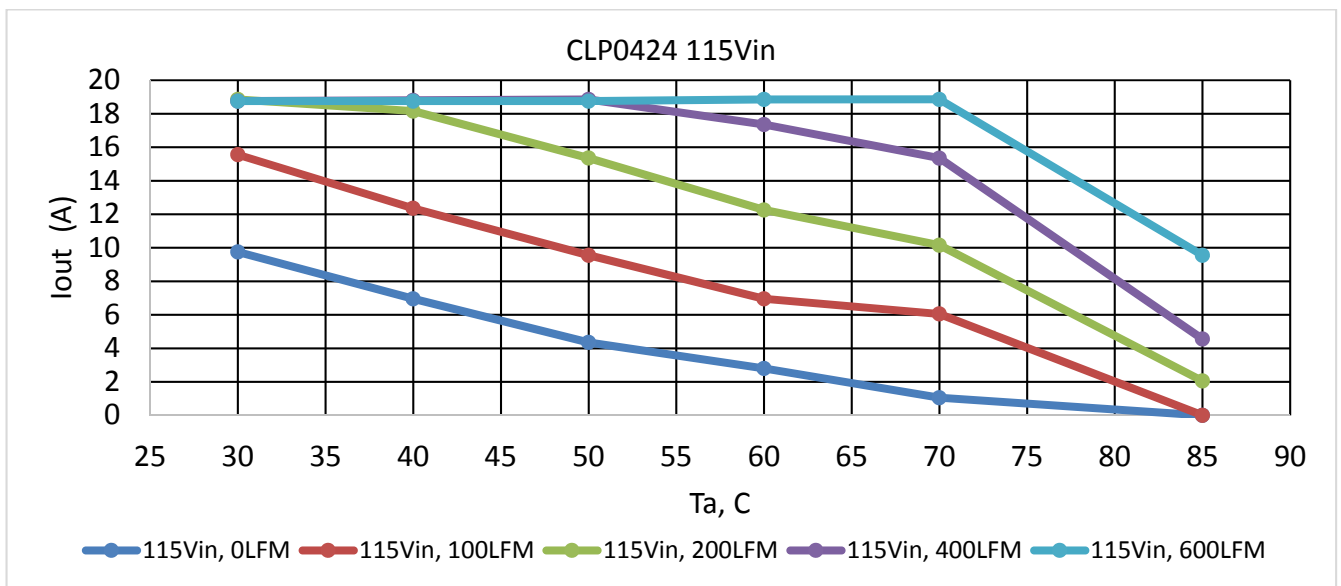

Figure 7. Typical Hold-up waveforms ( $V_{IN} = 230\text{V}$ , 100% load)

CLP0424/428 Open Frame Power Supply  
 90 - 265Vac input; 24/28Vdc output; 450W Output Power

Derating Curve (Open Frame Application)



CLP0424/428 Open Frame Power Supply  
 90 - 265Vac input; 24/28Vdc output; 450W Output Power

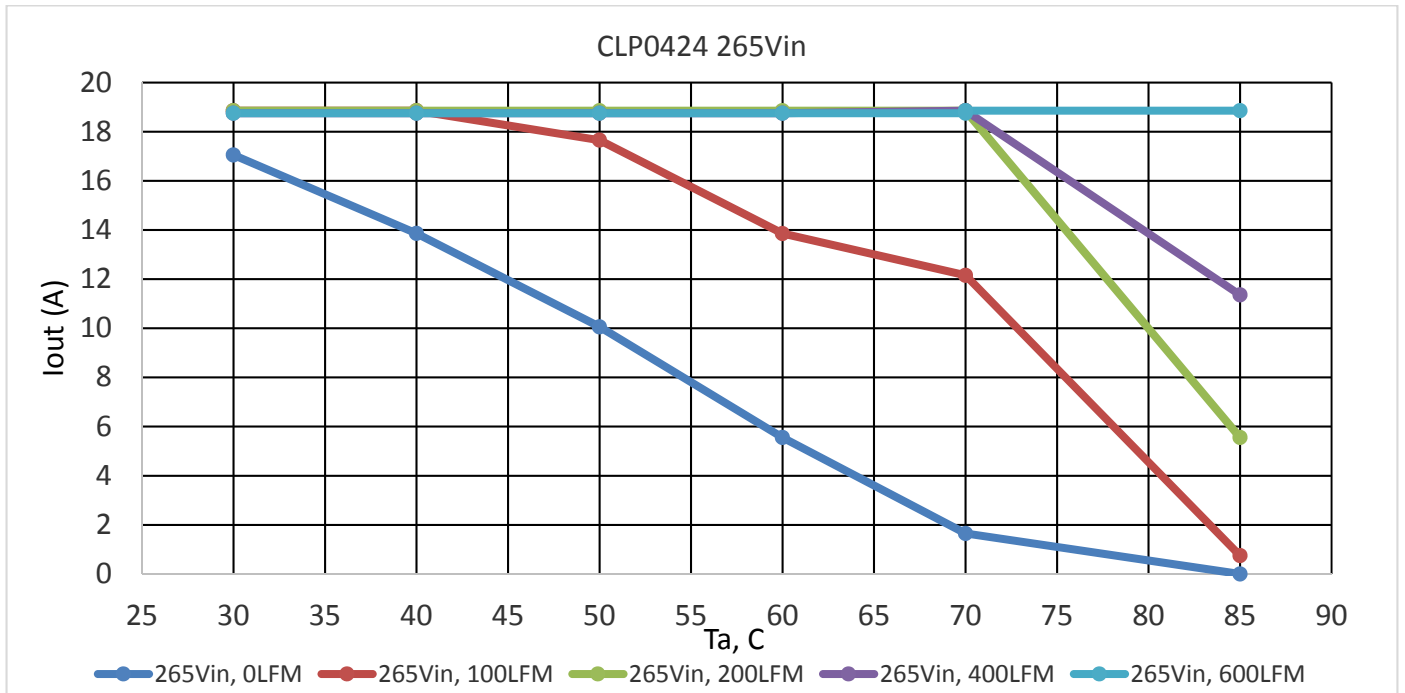

Derating Curve (Enclosure Application)

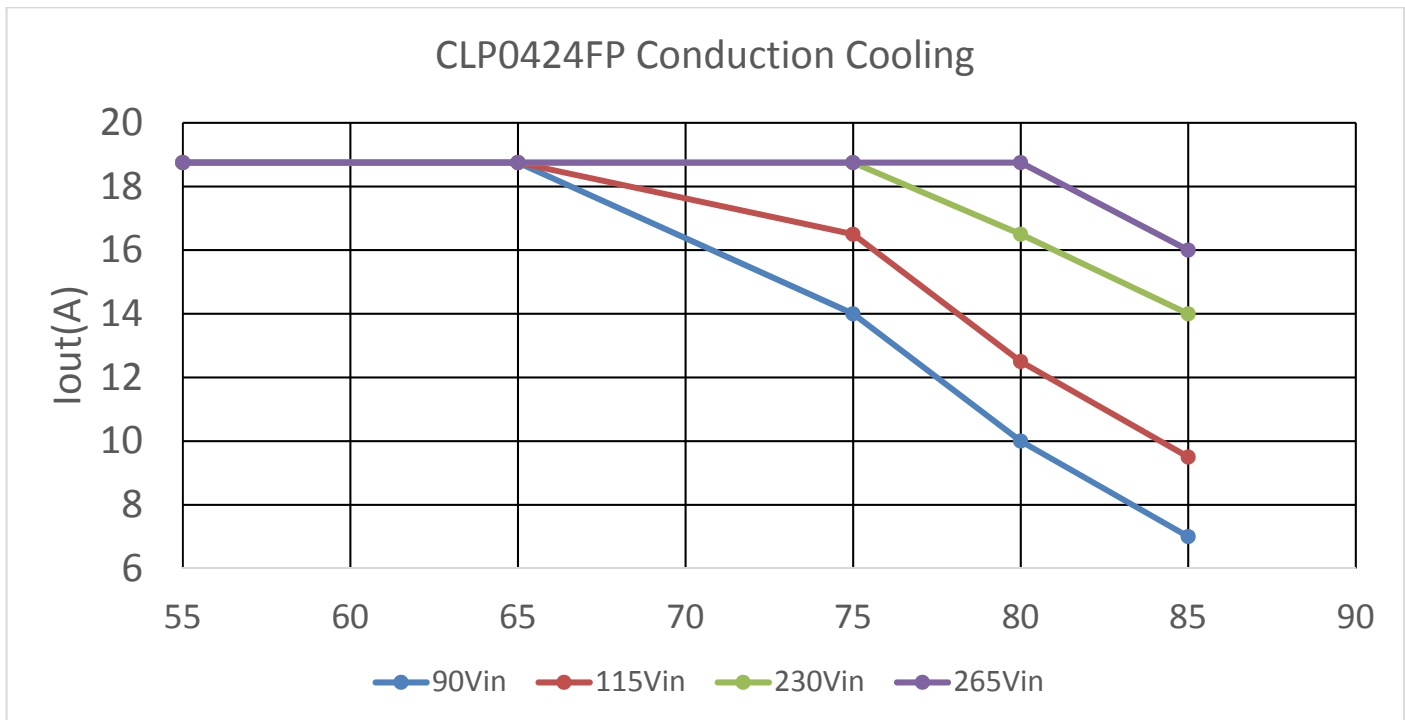



# CLP0424/428 Open Frame Power Supply

## 90 - 265Vac input; 24/28Vdc output; 450W Output Power

### Safety Considerations

The CLP0424 power supply is intended for inclusion in other equipment and the installer must ensure that it is complied with all the requirements of the end application. This product is only for inclusion by professional installers within other equipment and must not be operated as a stand-alone product. The power supply should meet Class 1, IEC60950, EN60950, with the following deviations: Nemko. UL 60950 (Recognized Component) C-UL (Canadian Approval by UL).

### Feature Descriptions

#### Standby Power Supply

A standby output of 5V in the CLP0424 power supply, shall come on when input in the operating range is applied.

#### Remote On/Off

The CLP0424 power supply shall feature a TTL-compatible On/Off control input. The power supply turns ON when the On/Off input goes low, and turns OFF when the input goes high. Note that if the On/Off pin is left unconnected, the power supply main output shall be ON.

#### Output Voltage Adjustment

The output voltage shall be capable of being adjusted between  $\pm 5\%$  around the nominal using a potentiometer on the power supply.

#### Remote Sense

The power supply shall have both positive and negative remote sense connections that can be connected to the positive and negative rails of the main output near the load. The power supply shall operate without the remote sense connections being made.

#### Overcurrent Protection

To provide protection in a fault condition (output overload), the power supply is equipped with internal current-limiting circuitry and can endure current limiting continuously. At the point of current-limit inception, the unit enters hiccup mode. The power supply operates normally once the output current is brought back into its specified range.

#### Overvoltage Protection

Overvoltage protection is a feature of the CLP0424 power supply that protects both the load and the power supply from an output overvoltage condition. When an overvoltage occurs, the power supply shuts down and latches off until the overvoltage condition is removed. It is necessary to recycle the input to restart the power supply when this protection is activated.

#### Overtemperature Protection

The CLP0424 also features overtemperature protection to provide additional protection in a fault condition. The power supply is equipped with a thermal shutdown circuit which detects excessive internal temperatures and shuts the unit down. Once the power supply goes into overtemperature

shutdown, it will cool before attempting to restart. The overtemperature protection circuit will typically kick in when the unit is operated at 450W output with an ambient temperature of TBD°C and 1m/s (200LFM) airflow.

#### Input Under Voltage Lockout

At input voltages below the input under voltage lockout limit, power supply operation shall be disabled. The power supply will begin to operate at an input voltage above the under-voltage lockout turn-on threshold

#### DC OK

The CLP0424 shall provide a DC OK signal that indicates when the output has come up and is in regulation. This is an open-collector type signal that goes high when the output is available and within regulation.

#### Power Good LED

A green LED on board the power supply shall illuminate when the main output voltage is above 90% of the nominal output voltage.

#### Paralleling with Active Output Current Sharing (option)

This power supply should be capable of parallel operation with active output current sharing in all options that have this feature. Paralleling of up to four power supplies should be supported. Paralleling will be accomplished by connecting the Current Share signals of multiple power supplies together. At load current levels above 20%, the output currents of multiple power supplies will be within  $\pm 5\%$  of the full load value.

# CLP0424/428 Open Frame Power Supply

90 - 265Vac input; 24/28Vdc output; 450W Output Power

## Thermal Considerations

The power supply can be operated in a variety of thermal environments, while sufficient cooling should be provided to ensure reliable operation.

Reliability should consider ambient temperature, airflow, power supply dissipation. A reduction in the operating temperature of the power supply will result in increased reliability. The power supply should be capable to deliver full output power of 450W/230Vac/200LFM at 50C or 450W/115Vacc/400LFM at 50C. The output power can be derated at higher output temperatures and lower airflow, and it should at least deliver 300W/115Vac/400LFM at 70C) of airflow.

In addition, in conduction-cooled applications with a suitable enclosure, the power supply should be capable to deliver 340W when the enclosure ambient temperature is 55°C, and 90VAC.

## Operation in a Sealed Enclosure

The CLP0424 power supply can also be operated in a sealed enclosure or in an environment where cooling is primarily via conduction. Figure 1 shows an arrangement where thermally conductive pads are used to transfer heat from the top and bottom of the power supply into the enclosure. Under such conditions, the power supply is capable of reduced power operation as shown in Table 1.

**Table 1. Output Power Capability when the CLP0424 is cooled primarily via conduction.**

Cold Wall Temperature (°C)	Max. Output Power (W)
90	340

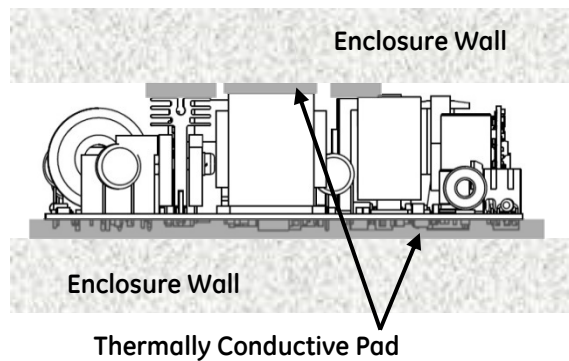
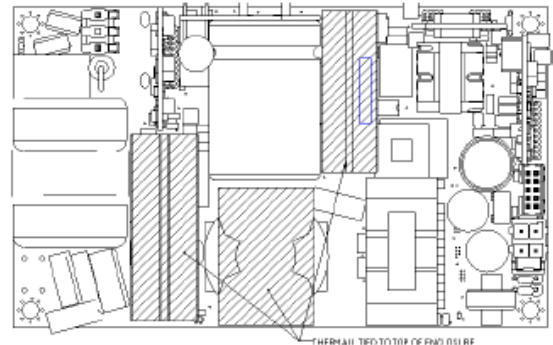

**Fig. 1. Example arrangement of the CLP0424 for sealed enclosure applications.**

## Heat Transfer Via Convection

Increased airflow through the power supply enhances the heat transfer via convection. Fig 2 shows the preferred airflow direction. Contact your GE technical representative for derating information in other airflow directions.

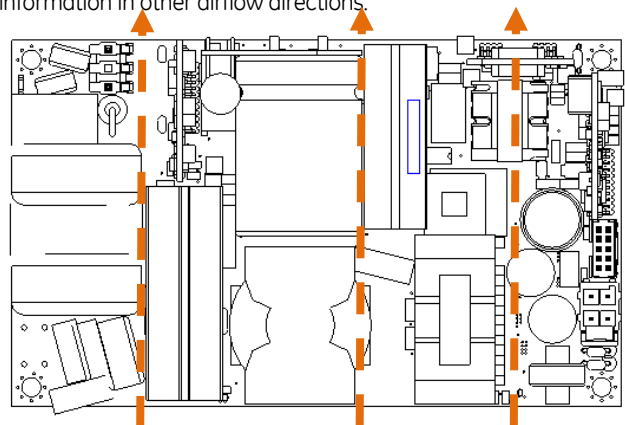

**Fig. 2. Preferred Airflow Direction for Cooling.**

# CLP0424/428 Open Frame Power Supply

90 - 265Vac input; 24/28Vdc output; 450W Output Power

## Mechanical Outline & Requirements

- The maximum outline of the power supply shall be 76.2 x 127 x 35mm

The top and sides views of the CLP0424 are shown below for reference.

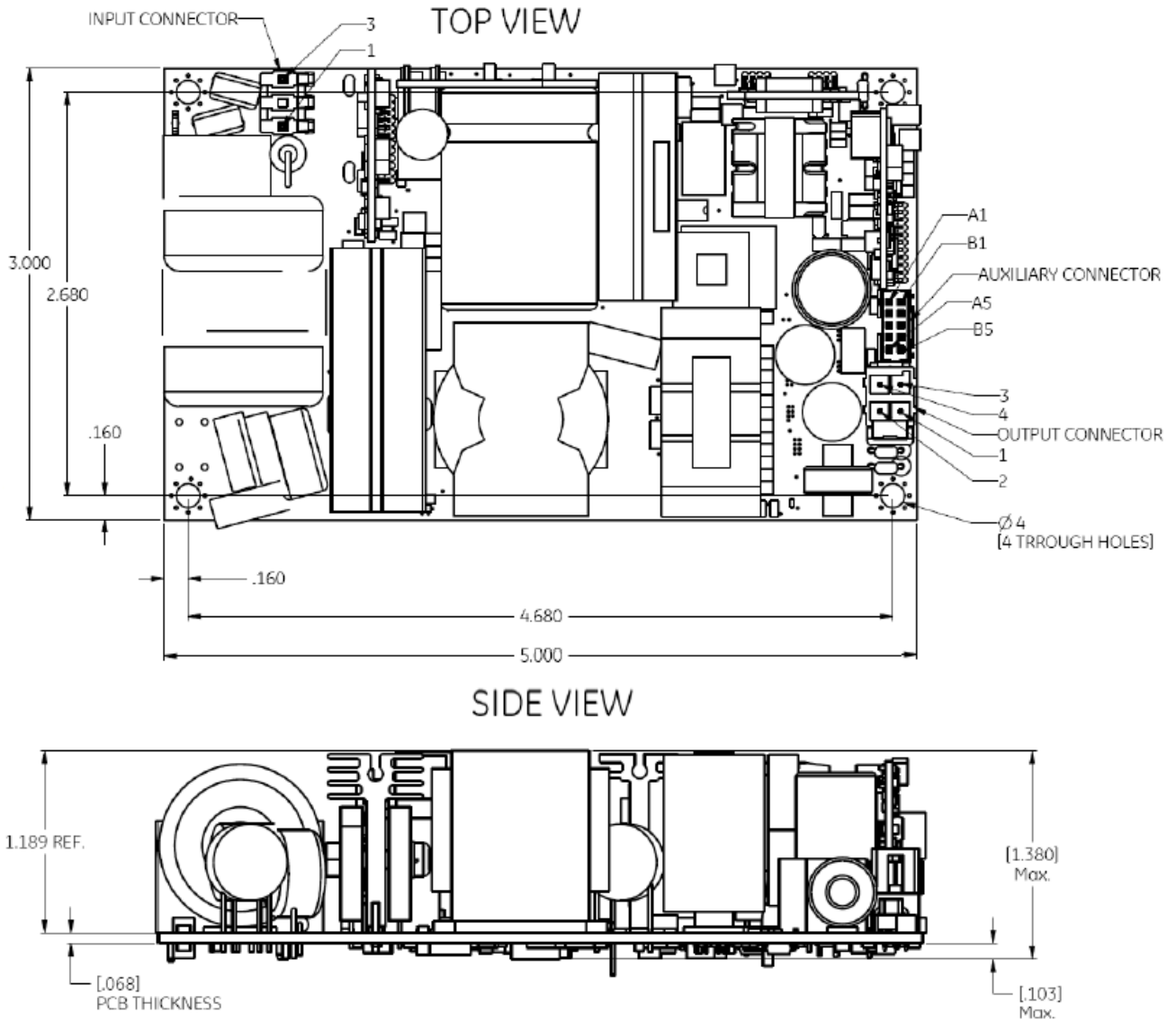

## CLP0424/428 Open Frame Power Supply

90 - 265Vac input; 24/28Vdc output; 450W Output Power

### Connector Information

Connector	Connector on Power Supply	Housing:
AC Input Connector (HDR200)	41671-3473 [Molex] (450048210) or equivalent	09-93-0300---KK® 3.96mm Crimp Terminal Housing, Friction Ramp, 3 Circuits, Glow Wire Compatible
DC Output Connector (HDR600)	Molex 172298-1204 (450053094) or equivalent	Molex 1722581104 or equivalent
Auxiliary Connector (HDR800)	98414-G06-10ULF [FCI] 450047899 or equivalent	FCI 10073599-010 or equivalent

### Pinout Information

Input Connector (HDR1)		DC Output Connector (HDR2)		Auxiliary Connector (HDR3)			
PIN 1	Line, VIN (+)	PINS 1	VOUT +	PIN A1	5V Standby	PIN B1	PARALLEL
PIN 2	NC (Removed)	PINS 2	VOUT +	PIN A2	5V Standby	PIN B2	5V Standby Return
PIN 3	Neutral, VIN (-)	PINS 3	VOUT – (Return)	PIN A3	NC	PIN B3	5V Standby Return
		PINS 4	VOUT – (Return)	PIN A4	REMOTE SENSE +	PIN B4	DC_OK
				PIN A5	REMOTE SENSE –	PIN B5	ON/OFF

## CLP0424/428 Open Frame Power Supply

90 - 265Vac input; 24/28Vdc output; 450W Output Power

### Ordering Information

Please contact your GE Sales Representative for pricing, availability and optional features.

**Table 1. Device Codes**

Device Code	Input Voltage Range	Output Voltage	Output Current	On/Off Control	Standby Supply	Temperature Range	Comcodes
CLP0424FPXXXZ01A	90 - 265Vac	24Vdc	18.8A	Negative Logic	5V @ 1A	-40 to 85°C	CLP0424FPXXXZ01A
CLP0428FPXXXZ01A	90 - 265Vac 100 - 300Vdc	28Vdc	16.1A	Negative Logic	5V @ 1A	-40 to 85°C	TBD

## Contact Us

For more information, call us at

USA/Canada:

**+1 877 546 3243**, or +1 972 244 9288

Asia-Pacific:

+86.021.54279977\*808

Europe, Middle-East and Africa:

+49.89.878067-280

[www.gecriticalpower.com](http://www.gecriticalpower.com)



GE Critical Power reserves the right to make changes to the product(s) or information contained herein without notice, and no liability is assumed as a result of their use or application. No rights under any patent accompany the sale of any such product(s) or information.