

HFBR-3810Z and HFBR-3810MSZ

650 nm Fiber Optics Link for DC to 10 Mbaud



Description

The Broadcom[®] HFBR-3810Z consists of an optic transmitter and receiver operating at 650 nm wavelength. The pin to pin air gap distance of 25.1 mm provides transient voltage suppression of 12 kV.

Applications

- Drives/Inverters
- Galvanic isolation on one single PCB

Features

- Data transmission at signal rates of DC to 10 MBaud
- DC coupled receiver with CMOS/TTL output for easy designs: no data encoding or digitizing circuitry required
- High noise immunity
- RoHS compliant
- Transient voltage suppression of up to 12 kV according IEC 60664-1
- Laser class 1 according to IEC-60825: Amendment 2001

HFBR-3810Z and HFBR-3810MSZ DC to 10 MBaud Data Link

NOTE: All the data in this specification refers to the following operating conditions and over lifetime unless otherwise stated.

Absolute Maximum Ratings

ATTENTION: Stresses above those listed here may cause permanent damage to the device. Exposure to absolute maximum rating conditions for extended periods may affect device reliability.

Parameter	Symbol	Min.	Max.	Units
Signaling Rate	f_s	DC	10	Mbd
Storage and Operating Temperature	$T_{S,O}$	-40	+85	°C
Receiver Supply Voltage	V_{CC}	-0.5	+5.5	V
Receiver Average Output Current	$I_{O,AVG}$	-16	16	mA
Receiver Output Power Dissipation	P_{OD}	—	80	mW
Transmitter Peak Forward Input Current ^a	$I_{F,PK}$	—	90	mA
Transmitter Reverse Input Voltage	V_R	—	3	V
Rated impulse voltage ^b	V_T	—	12	kV
Lead Soldering Cycle ^{c, d}	Temperature	T_{SOL}	+260	°C
	Time		10	seconds
Nominal Voltage of the supply system ^b	V_{eff}	—	1000	V

a. For $I_{F,PK} > 60\text{mA}$, the duty cycle factor must maintain $I_{F,AV} \leq 60\text{mA}$ and pulse width $\leq 1 \mu\text{s}$.

b. [IEC 60664-1] Overvoltage category 4; inhomogeneous field; pollution degree 3; material group 2; altitude up to 2000m for HFBR-3810MSZ and up to 3000m for HFBR-3810Z above sea level.

c. 1.6 mm below seating plane; wave soldering only.

d. MSL class 3.

Recommended Operating Conditions

Parameter	Symbol	Min.	Max.	Units
Ambient Temperature	T_A	-40	85	°C
Power Supply Voltage ^a	V_{CC}	4.75	5.25	V
Transmitter Peak Forward Current ^b	$I_{F,P}$	54	90	mA
Transmitter Average Forward Current ^b	$I_{F,AV}$	—	60	mA

a. <100mp-p noise.

b. Current applied at the transmitter must not exceed 50 μA in order to guarantee a logical "1" at the RX output.

Mechanical Dimensions

Parameter	Symbol	HFBR 3810Z	HFBR 3810MSZ	Units
Clearance	d_C	25.1	20.1	mm
Creepage	d_{CP}	28.7	23.1	mm
Clearance Internal ^a	d_{CI}	21.1	21.1	mm
Creepage Internal ^{a, b}	d_{CPI}	25.1	25.1	mm

a. Only air gap with nonconductive mold the distance is 24.6 mm.

b. CTI value of the housing material is 600.

Electrical Input Characteristics

Parameter	Symbol	Min.	Typ.	Max.	Units
Forward Voltage ^a	V_F	1.8	2.1	2.65	V
Forward Voltage Temperature Coefficient	$\Delta V_F / \Delta T$	—	-1.8	—	mV/°C
Reverse Input Breakdown Voltage ^b	V_{BR}	3.0	13	—	V
Diode Capacitance ^c	C_0	—	60	—	pF

a. $I_{F,dc} = 60$ mA.

b. $I_{F,dc} = -10$ μ A.

c. $V_F = 0$ V; $f = 1$ MHz.

Electrical Output Signal Characteristics

Parameter	Symbol	Min.	Typ.	Max.	Units	Condition
Supply Current (without LED current)	I_{CC}	—	27	45	mA	
High Level Output Voltage	V_{OH}	4.2	4.7	—	V	
Low Level Output Voltage	V_{OL}	—	0.22	0.4	V	
Output Risetime (10–90%) ^{a, b}	t_r	—	10	20	ns	
Output Falltime (90–10%) ^{a, b}	t_f	—	10	20	ns	
Power Supply Noise Immunity	PSNI	0.1	0.4	—	V _{pp}	Sine Wave, DC – 10 MHz

a. $C_L = 10$ pF.

b. In the recommended drive circuit.

Specified Link Performance

T_A = -40°C to +85°C, DC to 10 Mbaud, unless otherwise noted.

Parameter	Symbol	Min.	Typ	Max.	Unit	Condition
Signaling Rate	f _s	DC	—	10	Mbaud	NRZ
Pulse Width Variation ^a	PWV	80	—	120	ns	10 Mbaud
Propagation Delay Time ^b	t _D	—	95	—	ns	Assuming a delay of 10 ns from the application (already included)
Duty Cycle Distortion ^c	DCD	-10	—	+10	ns	10 Mbaud

a. Minimum/maximum duty cycle distortion ± 10 ns.

b. Determined from 50% of the rising edge of data_in to 50% of the consecutive falling edge of data_out.

c. ± 10% of the nominal pulse width.

Package Views – HFBR-3810Z

TOP

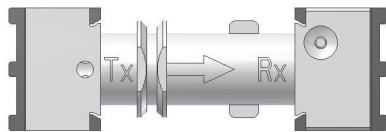

BOTTOM

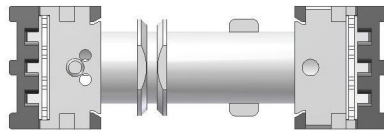

SIDE

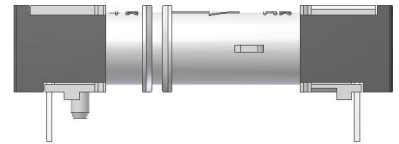

Package Views – HFBR-3810MSZ

TOP

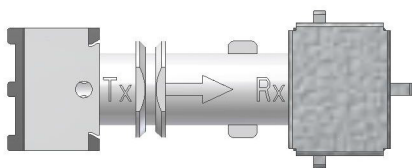

BOTTOM

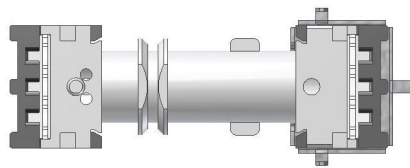

SIDE

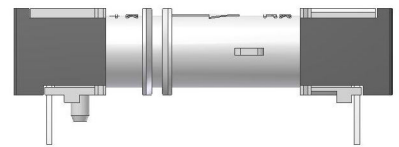

Mandatory Drive Circuit – Top View

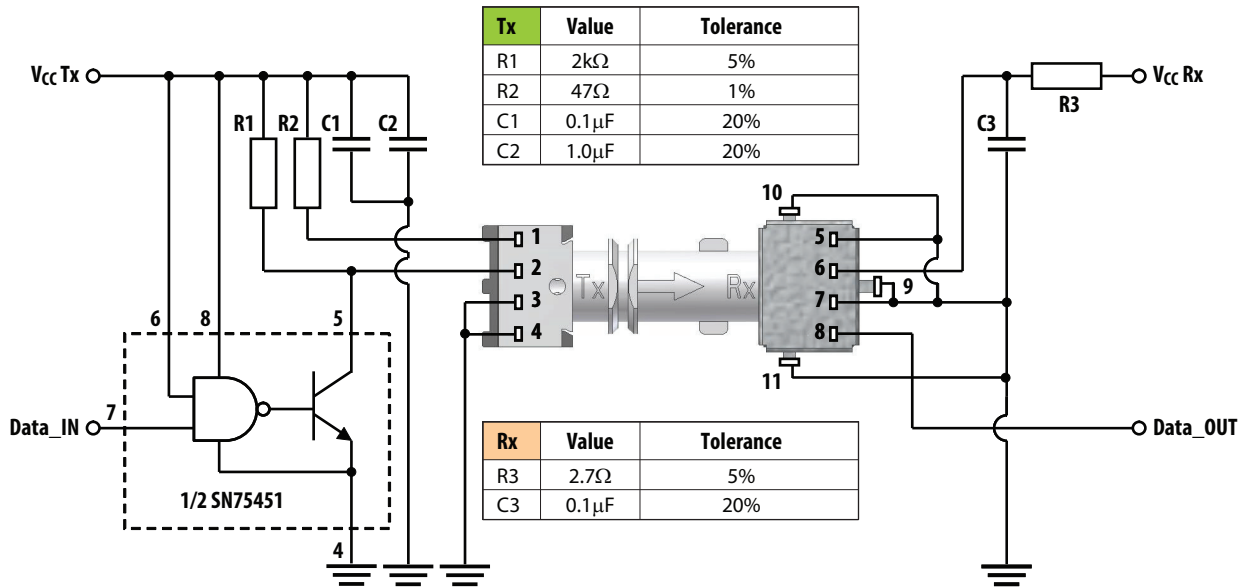

Pin Description

Pin Number	Transmitter
1	Anode
2	Cathode
3	GND
4	GND

Pin Number	Receiver
5	GND
6	VCC (5V)
7	GND
8	Data_OUT
9, 10, 11	GND (shield option ^a)

a. Pins 9,10, and 11 are not available if HFBR-3810Z is used and therefore do not need to be considered.

Mechanical Dimensions – HFBR-3810Z

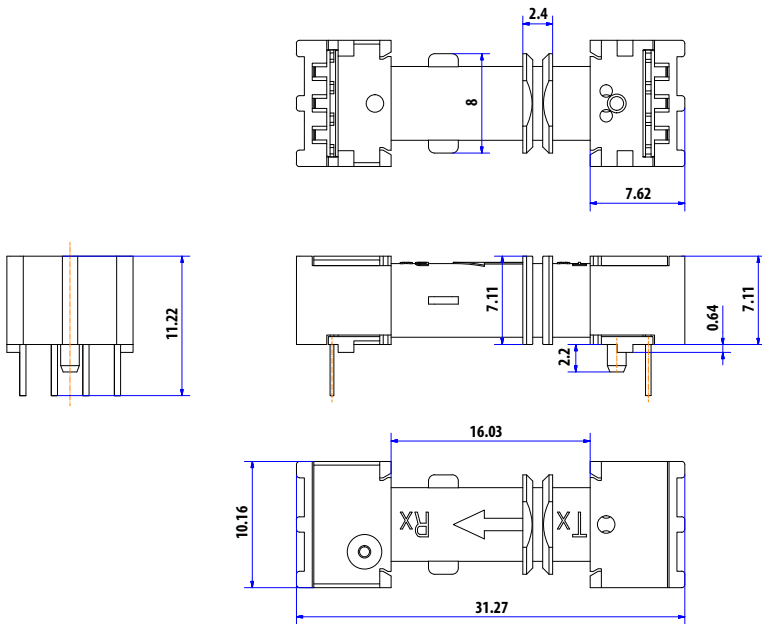

NOTE: Dimensions are in millimeters (mm).

Mechanical Dimensions – HFBR-3810MSZ

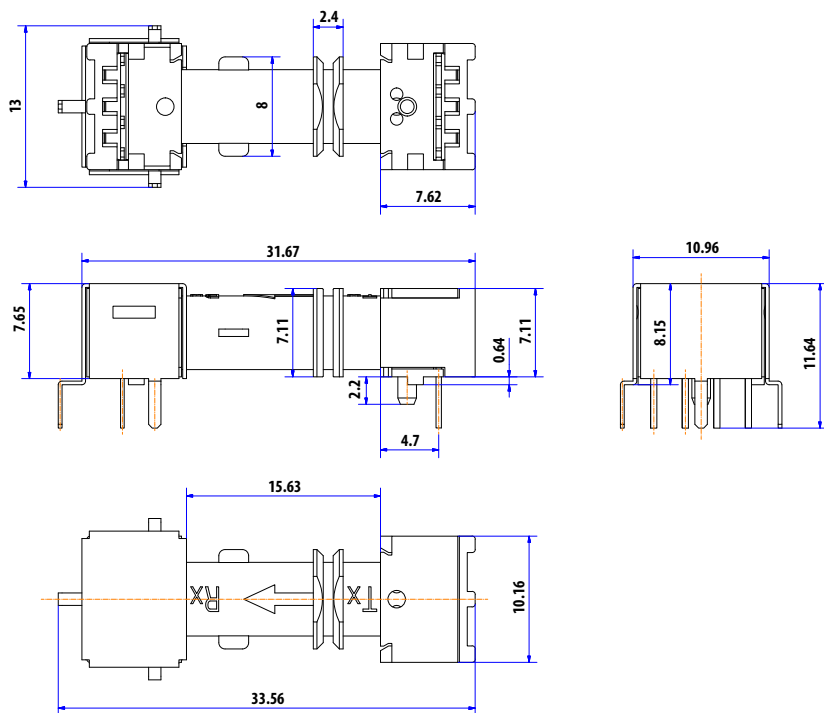

NOTE: Dimensions are in millimeters (mm).

Footprint Bottom View – HFBR-3810Z and HFBR-3810MSZ

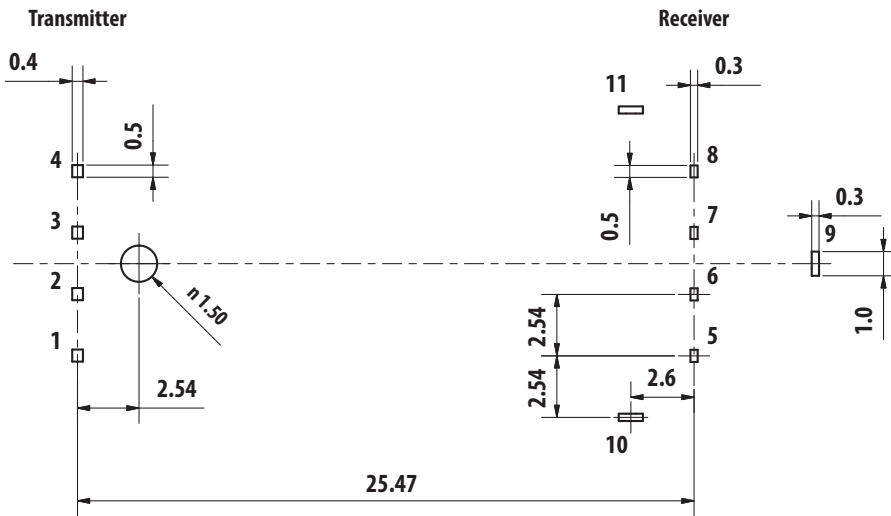

NOTE: Dimensions are in millimeters (mm).

Marking – HFBR-3810Z and HFBR-3810MSZ

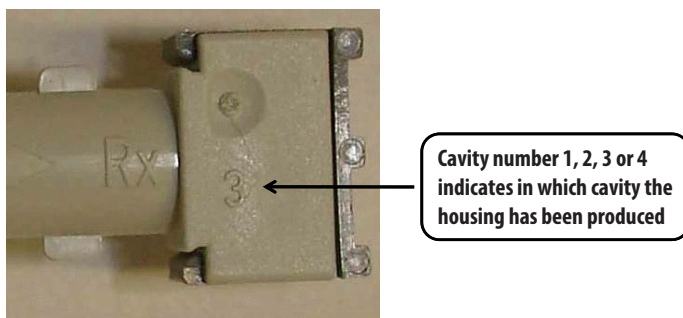
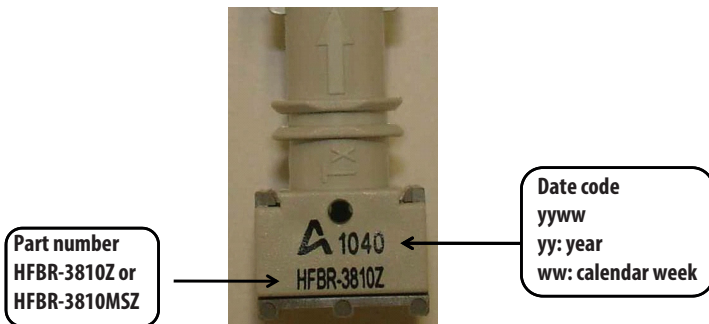

Broadcom, the pulse logo, Connecting everything, Avago Technologies, Avago, and the A logo are among the trademarks of Broadcom and/or its affiliates in the United States, certain other countries, and/or the EU.

Copyright © 2011–2018 Broadcom. All Rights Reserved.

The term “Broadcom” refers to Broadcom Inc. and/or its subsidiaries. For more information, please visit www.broadcom.com.

Broadcom reserves the right to make changes without further notice to any products or data herein to improve reliability, function, or design. Information furnished by Broadcom is believed to be accurate and reliable. However, Broadcom does not assume any liability arising out of the application or use of this information, nor the application or use of any product or circuit described herein, neither does it convey any license under its patent rights nor the rights of others.