

# Apacer Memory Product Specification

## 1024MB DDR2 32bits SDRAM SO-DIMM

1024MB DDR2 SDRAM 32bits SO-DIMM based 128Mx8, 8Banks, 1.8V DDR2 SDRAM with SPD

### Features

Performance range

(Bandwidth 5.3GB/sec)

Part No.	Max Freq. (Clock)	Speed Grade
78.02G87.405	333MHz(3ns@CL5)	667 Mbps

- JEDEC standard 1.8V ± 0.1V Power Supply
- VDDQ = 1.8V ± 0.1V
- Internal Bank: 8 Bank
- Posted CAS
- Programmable CAS Latency: 3, 4, 5
- Programmable Additive Latency: 0, 1, 2, 3 and 4
- Write Latency(WL) = Read Latency(RL) -1
- Burst Length: 4, 8(Interleave/nibble sequential)
- Programmable Sequential / Interleave Burst Mode
- Bi-directional Differential Data-Strobe (Single-ended data-strobe is an optional feature)
- Off-Chip Driver(OCD) Impedance Adjustment
- On Die Termination
- Refresh and Self Refresh
  - Average Refresh Period 7.8us
- Serial presence detect with EEPROM
- Compliance with RoHS
- Compliance with CE
- Operating Temperature Rang:
  - Commercial 0°C ≤ TC ≤ 85°C
  - Refresh: auto-refresh, self-refresh
    - Average refresh period
    - 7.8us at 0°C ≤ TC ≤ 85°C
    - 3.9us at 85°C ≤ TC ≤ 95°C

### Description

This module is 256M x 32 bit Double Data Rate SDRAM high density memory modules based on first generation of 1024MB DDR2 SDRAM respectively.

It consists of sixteen CMOS 128M x 8bit with 8banks Double Data Rate SDRAMs in 60Ball FBGA packages mounted on a 200pin glass-epoxy substrate. Three 0.1uF decoupling capacitors are mounted on the printed circuit board in parallel for each DDR2 SDRAM.

Synchronous design allows precise cycle control with the use of system clock. Data I/O transactions are possible on both edges of DQS. Range of operating frequencies, programmable latencies and burst lengths allow the same device to be useful for a variety of high bandwidth, high performance memory system applications.

# Apacer Memory Product Specification

## Pin Configurations (Front side/Back side)

Pin	Front	Pin	Back	Pin	Front	Pin	Back	Pin	Front	Pin	Back	Pin	Front	Pin	Back
1	V <sub>REF</sub>	2	V <sub>SS</sub>	51	DQS2	52	DM2	101	A1	102	A0	151	NC	152	NC
3	V <sub>SS</sub>	4	DQ4	53	V <sub>SS</sub>	54	V <sub>SS</sub>	103	V <sub>DD</sub>	104	V <sub>DD</sub>	153	NC	154	NC
5	DQ0	6	DQ5	55	DQ18	56	DQ22	105	A10/AP	106	BA1	155	V <sub>SS</sub>	156	V <sub>SS</sub>
7	DQ1	8	V <sub>SS</sub>	57	DQ19	58	DQ23	107	BA0	108	RAS	157	NC	158	NC
9	V <sub>SS</sub>	10	DM0	59	V <sub>SS</sub>	60	V <sub>SS</sub>	109	WE	110	S0	159	NC	160	NC
11	DQS0	12	V <sub>SS</sub>	61	DQ24	62	DQ28	111	V <sub>DD</sub>	112	V <sub>DD</sub>	161	V <sub>SS</sub>	162	V <sub>SS</sub>
13	DQS0	14	DQ6	63	DQ25	64	DQ29	113	CAS	114	ODT0	163	NC, TEST	164	CK1
15	V <sub>SS</sub>	16	DQ7	65	V <sub>SS</sub>	66	V <sub>SS</sub>	115	NC/S1	116	A13	165	V <sub>SS</sub>	166	CK1
17	DQ2	18	V <sub>SS</sub>	67	DM3	68	DQS3	117	V <sub>DD</sub>	118	V <sub>DD</sub>	167	NC	168	V <sub>SS</sub>
19	DQ3	20	DQ12	69	NC	70	DQS3	119	NC/ODT1	120	NC	169	NC	170	NC
21	V <sub>SS</sub>	22	DQ13	71	V <sub>SS</sub>	72	V <sub>SS</sub>	121	V <sub>SS</sub>	122	V <sub>SS</sub>	171	V <sub>SS</sub>	172	V <sub>SS</sub>
23	DQ8	24	V <sub>SS</sub>	73	DQ26	74	DQ30	123	NC	124	NC	173	NC	174	NC
25	DQ9	26	DM1	75	DQ27	76	DQ31	125	NC	126	NC	175	NC	176	NC
27	V <sub>SS</sub>	28	V <sub>SS</sub>	77	V <sub>SS</sub>	78	V <sub>SS</sub>	127	V <sub>SS</sub>	128	V <sub>SS</sub>	177	V <sub>SS</sub>	178	V <sub>SS</sub>
29	DQS1	30	CK0	79	CKE0	80	NC/CKE1	129	NC	130	NC	179	NC	180	NC
31	DQS1	32	CK0	81	V <sub>DD</sub>	82	V <sub>DD</sub>	131	NC	132	V <sub>SS</sub>	181	NC	182	NC
33	V <sub>SS</sub>	34	V <sub>SS</sub>	83	NC	84	NC	133	V <sub>SS</sub>	134	NC	183	V <sub>SS</sub>	184	V <sub>SS</sub>
35	DQ10	36	DQ14	85	BA2	86	NC	135	NC	136	NC	185	NC	186	NC
37	DQ11	38	DQ15	87	V <sub>DD</sub>	88	V <sub>DD</sub>	137	NC	138	V <sub>SS</sub>	187	V <sub>SS</sub>	188	NC
39	V <sub>SS</sub>	40	V <sub>SS</sub>	89	A12	90	A11	139	V <sub>SS</sub>	140	NC	189	NC	190	V <sub>SS</sub>
41	V <sub>SS</sub>	42	V <sub>SS</sub>	91	A9	92	A7	141	NC	142	NC	191	NC	192	NC
43	DQ16	44	DQ20	93	A8	94	A6	143	NC	144	V <sub>SS</sub>	193	V <sub>SS</sub>	194	NC
45	DQ17	46	DQ21	95	V <sub>DD</sub>	96	V <sub>DD</sub>	145	V <sub>SS</sub>	146	NC	195	SDA	196	V <sub>SS</sub>
47	V <sub>SS</sub>	48	V <sub>SS</sub>	97	A5	98	A4	147	NC	148	NC	197	SCL	198	SA0
49	DQS2	50	NC	99	A3	100	A2	149	V <sub>SS</sub>	150	V <sub>SS</sub>	199	V <sub>DD</sub> SPD	200	SA1

## Pin Description

Pin Name	Function	Pin Name	Function
CK0,CK1	Clock Inputs, positive line	SDA	SPD Data Input/Output
CK0,CK1	Clock Inputs, negative line	SA1,SA0	SPD address
CKE0,CKE1	Clock Enables	DQ0~DQ31	Data Input/Output
RAS	Row Address Strobe	DM0~DM3	Data Masks
CAS	Column Address Strobe	DQS0~DQS3	Data strobes
WE	Write Enable	DQS0~DQS3	Data strobes complement
S0	Chip Selects	TEST	Logic Analyzer specific test pin (No connect on So-DIMM)
A0~A9, A11~A13	Address Inputs	V <sub>DD</sub>	Core and I/O Power
A10/AP	Address Input/Autoprecharge	V <sub>SS</sub>	Ground
BA0,BA2	SDRAM Bank Address	V <sub>REF</sub>	Input/Output Reference
ODT0,ODT1	On-die termination control	V <sub>DD</sub> SPD	SPD Power
SCL	Serial Presence Detect (SPD) Clock Input	NC	Spare pins, No connect

# Apacer Memory Product Specification

## Input/Output Functional Description

Symbol	Type	Function
CK0-CK1 CK0-CK1	Input	The system clock inputs. All address and command lines are sampled on the cross point of the rising edge of CK and falling edge of CK. A Delay Locked Loop (DLL) circuit is driven from the clock input and output timing for read operations is synchronized to the input clock.
CKE0-CKE1	Input	Activates the DDR2 SDRAM CK signal when high and deactivates the CK signal when low, By deactivating the clocks, CKE low initiates the Power Down mode or the Self Refresh mode.
$\overline{S0}$	Input	Enables the associated DDR2 SDRAM command decoder when low and disables the command decoder when high. When the command decoder is disabled, new commands are ignored but previous operations continue. Rank 0 is selected by $\overline{S0}$ , Rank 1 is selected by $\overline{S1}$ . Ranks are also called "Physical banks".
$\overline{RAS}$ , $\overline{CAS}$ , $\overline{WE}$	Input	When sampled at the cross point of the rising edge of CK and falling edge of $\overline{CK}$ , $\overline{CAS}$ , $\overline{RAS}$ , and $\overline{WE}$ define the operation to be executed by the SDRAM.
BA0~BA2	Input	Selects which DDR2 SDRAM internal bank is activated.
ODT0~ODT1	Input	Asserts on-die termination for DQ, DM, DQS, and $\overline{DQS}$ signals if enabled via the DDR2 SDRAM Extended Mode Register Set (EMRS).
A0~A9, A10/AP, A11~A13	Input	During a Bank Activate command cycle, $\overline{A0}$ defines the row address when sampled at the cross point of the rising edge of CK and falling edge of $\overline{CK}$ . During a Read or Write command cycle, $\overline{A0}$ defines the column address when sampled at the cross point of the rising edge of CK and falling edge of CK. In addition to the column address, AP is used to invoke autoprecharge operation at the end of the burst read or write cycle. If AP is high, autoprecharge is selected and BA0-BAn defines the bank to be precharged. If AP is low, autoprecharge is disabled. During a Precharge command cycle, AP is used in conjunction with BA0-BAn to control which bank(s) to precharge. If AP is high, all banks will be precharged regardless of the state of BA0-BAn inputs. If AP is low, then BA0-BAn are used to define which bank to precharge.
DQ0~DQ31	In/Out	Data Input/Output pins.
DM0~DM3	Input	The data write masks, associated with one data byte. In Write mode, DM operates as a byte mask by allowing input data to be written if it is low but blocks the write operation if it is high. In Read mode, DM lines have no effect.
DQS0~DQS3 $\overline{DQS0}$ ~ $\overline{DQS3}$	In/Out	The data strobes, associated with one data byte, sourced with data transfers. In Write mode, the data strobe is sourced by the controller and is centered in the data window. In Read mode, the data strobe is sourced by the DDR2 SDRAMs and is sent at the leading edge of the data window. $\overline{DQS}$ signals are complements, and timing is relative to the crosspoint of respective DQS and $\overline{DQS}$ If the module is to be operated in single ended strobe mode, all DQS signals must be tied on the system board to VSS and DDR2 SDRAM mode registers programmed appropriately.
$V_{DD}$ , $V_{DD}$ SPD, $V_{SS}$	Supply	Power supplies for core, I/O, Serial Presence Detect, and ground for the module.
SDA	In/Out	This is a bidirectional pin used to transfer data into or out of the SPD EEPROM. A resistor must be connected to $V_{DD}$ to act as a pull up.
SCL	Input	This signal is used to clock data into and out of the SPD EEPROM. A resistor may be connected from SCL to $V_{DD}$ to act as a pull up.
SA0~SA1	Input	Address pins used to select the Serial Presence Detect base address.
TEST	In/Out	The TEST pin is reserved for bus analysis tools and is not connected on normal memory modules(SO-DIMMs).

# Apacer Memory Product Specification

## FUNCTIONAL BLOCK DIAGRAM

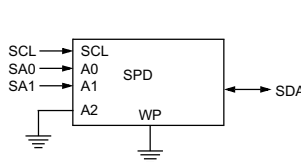
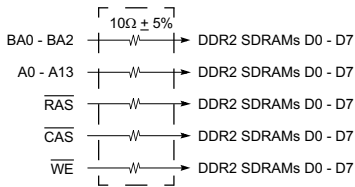
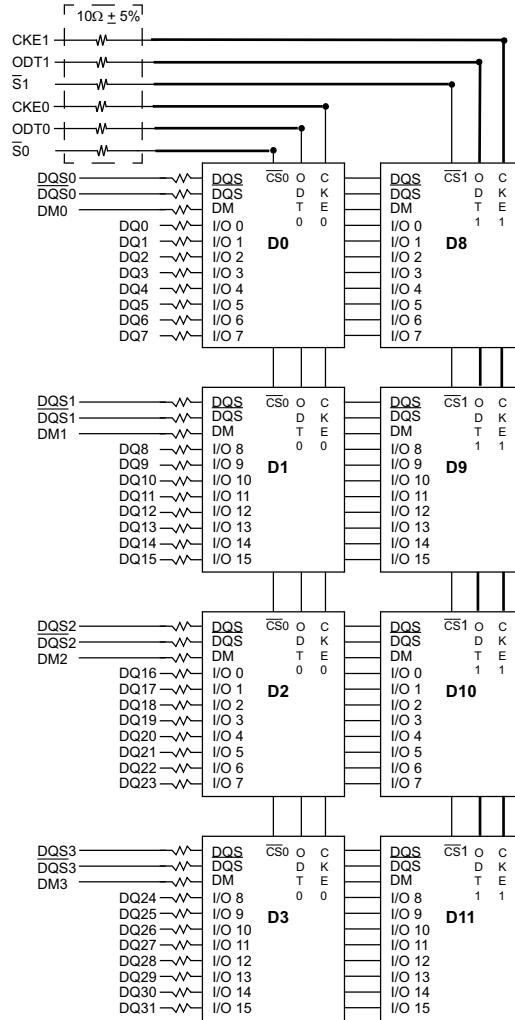

* Clock Wiring	
Clock Input	DDR2 SDRAMs
*CK0/CK0	8 DDR2 SDRAMs
*CK1/CK1	8 DDR2 SDRAMs

\* Wire per Clock Loading Table/Wiring Diagrams

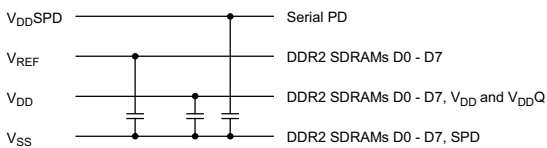

- Notes :**
1. DQ,DM,  $\overline{DQS}/\overline{DQS}$  resistors : 22 Ohms  $\pm$  5%.
  2. BAx, Ax, RAS, CAS, WE resistors : 3.0 Ohms  $\pm$  5%.

# Apacer Memory Product Specification

## PACKAGE DIMENSIONS

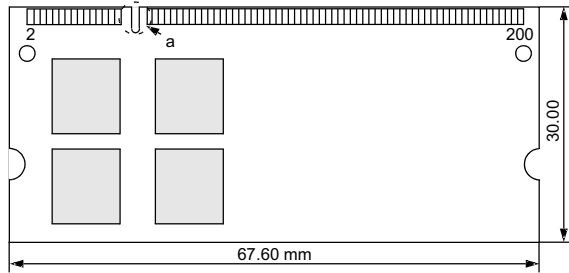
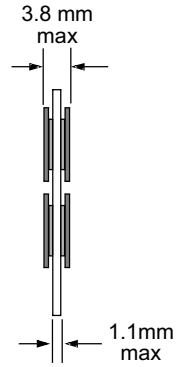
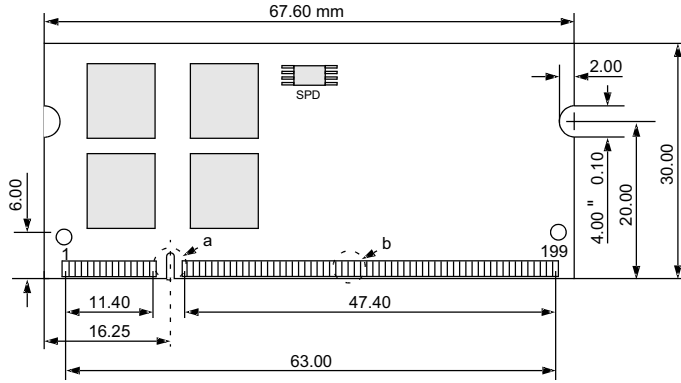

**DETAIL a**

**DETAIL b**

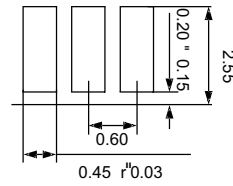
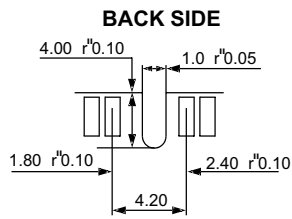
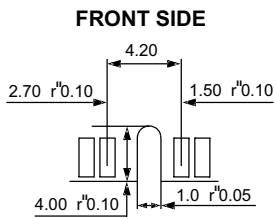

Tolerances: +0.15mm unless otherwise specified