

## High-resolution, high-stability 3-axis digital accelerometer

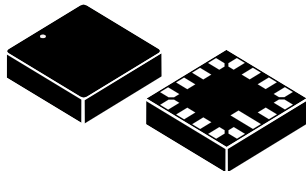

**Ceramic cavity LGA-16**  
(5x5x1.7 mm)



### Features

- Included in the 10-year longevity program
- 3-axis,  $\pm 2.5 g$  full-scale
- Ultra-low noise performance:  $45 \mu g/\sqrt{Hz}$
- Excellent stability over temperature ( $<0.4 mg/^\circ C$ ) and time
- 16-bit data output
- SPI 4-wire digital output interface
- Embedded FIFO (depth 32 levels)
- Embedded temperature sensor
- 12-bit temperature data output
- High shock survivability
- Extended operating temperature range ( $-40^\circ C$  to  $+85^\circ C$ )
- ECOPACK<sup>®</sup>, RoHS and “Green” compliant

### Applications

- Precision inclinometer
- Antenna and platform pointing and leveling
- Leveling instruments

### Description

The IIS3DHHC is an ultra-low noise, high-stability three-axis linear accelerometer.

The IIS3DHHC has a full scale of  $\pm 2.5 g$  and is capable of providing the measured accelerations to the application through an SPI 4-wire digital interface.

The sensing element is manufactured using a dedicated micromachining process developed by STMicroelectronics to produce inertial sensors and actuators on silicon wafers.

The IC interface is manufactured using a CMOS process that allows a high level of integration to design a dedicated circuit which is trimmed to better match the characteristics of the sensing element.

The IIS3DHHC is available in a high-performance (low-stress) ceramic cavity land grid array (CC LGA) package and can operate within a temperature range of  $-40^\circ C$  to  $+85^\circ C$ .

Maturity status link	
<a href="#">IIS3DHHC</a>	
Device summary	
<b>Order code</b>	IIS3DHHCTR
<b>Temperature range [°C]</b>	-40 to +85
<b>Package</b>	CC LGA-16 (5x5x1.7 mm)
<b>Packing</b>	Tape and reel



## 2 Mechanical and electrical specifications

### 2.1 Mechanical characteristics

@ Vdd = 2.8 V, T = 25 °C unless otherwise noted.

**Table 2. Mechanical characteristics**

Symbol	Parameter	Test condition	Min. <sup>(1)</sup>	Typ. <sup>(2)</sup>	Max. <sup>(1)</sup>	Unit
FS	Measurement range <sup>(3)</sup>			±2.5		g
So	Sensitivity <sup>(4)</sup>		-7%	0.076	+7%	mg/digit
TCSO	Sensitivity change vs. temperature	From -40 °C to +85 °C, delta from 25°C	-1.35	0.7	+1.35	%
Off	Zero-g level offset accuracy <sup>(5)</sup>		-35	±20	+35	mg
TCOff	Zero-g level change vs. temperature <sup>(6)</sup>	From -40 °C to +85 °C, delta from 25 °C	-0.4		0.4	mg/°C
NL	Non linearity	Best-fit straight line			2	% FS
Zgn	Zero-g noise density	FS = ±2.5 g		45	65	µg/√(Hz)
ODR	Digital output data rate			1.1		kHz
Bw	Bandwidth	For both FIR and IIR filters		235 or 440		Hz
StartT	Startup time	For cold start condition			150	ms
ST	Self-test positive difference <sup>(7)</sup>	X, Y-axis	75		650	mg
		Z-axis	75		1400	
Top	Operating temperature range		-40		+85	°C

1. Min/Max values are based on characterization results, not tested in production and not guaranteed.
2. Typical specifications are not guaranteed.
3. Sensor is designed with larger dynamic to avoid variation of FS limits in the operative bandwidth. Consequently to trim operations at factory final test.
4. Sensitivity range after MSL3 preconditioning.
5. Typical zero-g level offset value after MSL3 preconditioning.
6. Valid if OFF\_TCOMP\_EN in Section 7.4 CTRL\_REG4 (23h) is set to '1'. Min/max at 3 sigma. Based on characterization data for a limited number of samples, not measured during final test for production.
7. Self-test positive difference is defined as:  $OUTPUT[mg](Section\ 7.4\ CTRL\_REG4\ (23h)\ ST2,\ ST1\ bits = 01) - OUTPUT[mg](Section\ 7.4\ CTRL\_REG4\ (23h)\ ST2,\ ST1\ bits = 00)$  in steady state.

## 2.2 Electrical characteristics

@ Vdd = 2.8 V, T = 25 °C unless otherwise noted.

**Table 3. Electrical characteristics**

Symbol	Parameter	Test condition	Min.	Typ. <sup>(1)</sup>	Max.	Unit
Vdd	Supply voltage		1.71	2.8	3.6	V
Vdd_IO	I/O pins supply voltage		1.71		Vdd+0.1	V
Idd	Supply current			2.5	5	mA
V <sub>IH</sub>	Digital high-level input voltage		0.7*Vdd_IO			V
V <sub>IL</sub>	Digital low-level input voltage				0.3*Vdd_IO	V
V <sub>OH</sub>	High-level output voltage	I <sub>OH</sub> = 4 mA <sup>(2)</sup>	Vdd_IO - 0.2			V
V <sub>OL</sub>	Low-level output voltage	I <sub>OL</sub> = 4 mA <sup>(2)</sup>			0.2	V
Top	Operating temperature range		-40		+85	°C
SPI_Fr	SPI frequency	4-wire interface		5	10	MHz
Trise	Time for power supply rising <sup>(3)</sup>		0.01		100	ms
Twait	Time delay between Vdd_IO and Vdd <sup>(3)</sup>		0		10	ms

1. Typical specifications are not guaranteed.

2. 4 mA is the maximum driving capability, i.e. the maximum DC current that can be sourced/sunk by the digital pad in order to guarantee the correct digital output voltage levels V<sub>OH</sub> and V<sub>OL</sub>.

3. Please refer to [Figure 2. Recommended power-up sequence](#) for more details.

### 2.2.1 Recommended power-up sequence

For the power-up sequence please refer to the following figure, where:

- Trise is the time for the power supply to rise from 10% to 90% of its final value
- Twait is the time delay between the end of the Vdd\_IO ramp (90% of its final value) and the start of the Vdd ramp

In the power-down sequence Vdd and Vdd\_IO can come down in any order.

**Figure 2. Recommended power-up sequence**

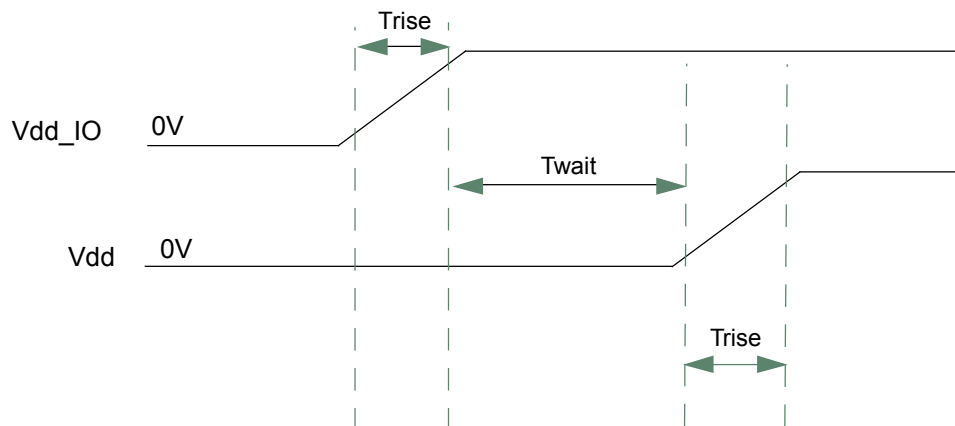

## 2.3 Temperature sensor characteristics

@ Vdd = 2.8 V, T = 25 °C unless otherwise noted.

**Table 4. Temperature sensor characteristics**

Symbol	Parameter	Test condition	Min. <sup>(1)</sup>	Typ. <sup>(2)</sup>	Max. <sup>(1)</sup>	Unit
TSDr	Temperature sensor output change vs. temperature			16		digit/°C
Tn	Temperature sensor noise ( <i>RMS</i> )				0.1	°C
Ta	Temperature accuracy		-15		+15	°C
TODR	Temperature refresh rate	Equal to ODR/16	62.5			Hz
TNL	Temperature nonlinearity	Best-fit straight line		5		% Top
Top	Operating temperature range		-40		+85	°C

1. *Min/Max values are based on characterization results, not tested in production and not guaranteed*

2. *Typical specifications are not guaranteed.*

### 3 Absolute maximum ratings

Stresses above those listed as “Absolute maximum ratings” may cause permanent damage to the device. This is a stress rating only and functional operation of the device under these conditions is not implied. Exposure to maximum rating conditions for extended periods may affect device reliability.

**Table 5. Absolute maximum ratings**

Symbol	Ratings	Maximum value	Unit
Vdd and Vdd_IO	Supply voltage	-0.3 to 4.8	V
T <sub>STG</sub>	Storage temperature range	-40 to +85	°C
Sg	Acceleration g for 0.2 ms	10,000	g
ESD	Electrostatic discharge protection (HBM)	2	kV
Vin	Input voltage on any control pin (including CS, SPC, SDI, SDO)	-0.3 to Vdd_IO +0.3	V

*Note:* Supply voltage on any pin should never exceed 4.8 V.



This device is sensitive to mechanical shock, improper handling can cause permanent damage to the part.



This device is sensitive to electrostatic discharge (ESD), improper handling can cause permanent damage to the part.

## 4 Communication interface characteristics

### 4.1 SPI - serial peripheral interface

Subject to general operating conditions for Vdd and Top.

**Table 6. SPI slave timing values**

Symbol	Parameter	Value		Unit
		Min	Max	
$t_{c(SPC)}$	SPI clock cycle	100		ns
$f_{c(SPC)}$	SPI clock frequency		10	MHz
$t_{su(CS)}$	CS setup time	5		ns
$t_{h(CS)}$	CS hold time	20		
$t_{su(SI)}$	SDI input setup time	5		
$t_{h(SI)}$	SDI input hold time	15		
$t_{v(SO)}$	SDO valid output time		35	
$t_{h(SO)}$	SDO output hold time	5		
$t_{dis(SO)}$	SDO output disable time		50	

1. Values are guaranteed at 10 MHz clock frequency for SPI 4 wires, based on characterization results, not tested in production

**Figure 4. SPI slave timing diagram**

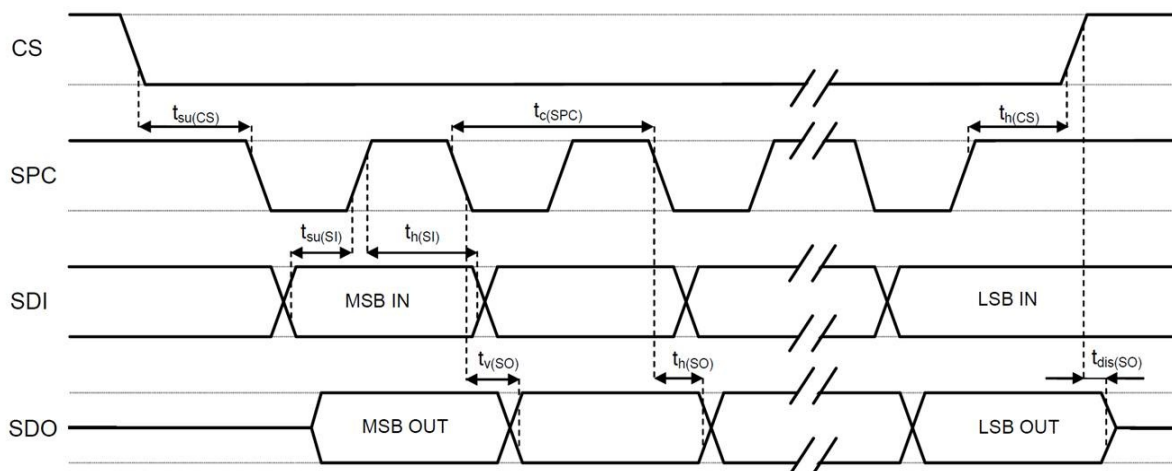

**Note:** Measurement points are done at  $0.2 \cdot V_{dd\_IO}$  and  $0.8 \cdot V_{dd\_IO}$ , for both input and output ports.

The SPI state machine is reset each time the CS signal is de-asserted.

## 4.2 SPI bus interface

The IIS3DHHHC SPI is a bus slave. The SPI allows writing to and reading from the registers of the device.

The serial interface interacts with the application using 4 wires: **CS**, **SPC**, **SDI** and **SDO**.

**Figure 5. Read and write protocol**

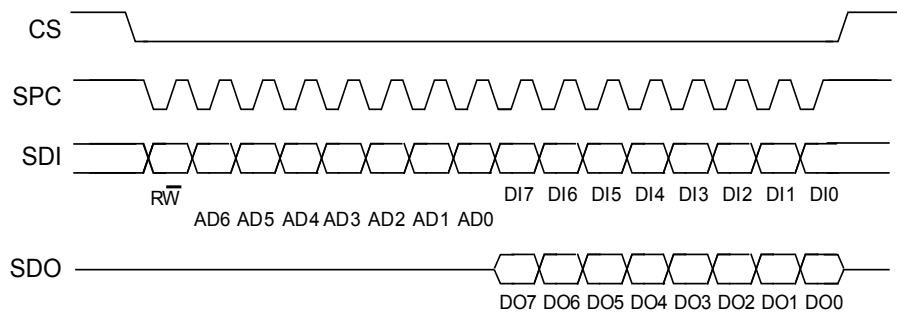

**CS** is the serial port enable and it is controlled by the SPI master. It goes low at the start of the transmission and goes back high at the end. **SPC** is the serial port clock and it is controlled by the SPI master. It is stopped high when **CS** is high (no transmission). **SDI** and **SDO** are respectively the serial port data input and output. These lines are driven at the falling edge of **SPC** and should be captured at the rising edge of **SPC**.

Both the read register and write register commands are completed in 16 clock pulses or in multiples of 8 in case of multiple read/write bytes. Bit duration is the time between two falling edges of **SPC**. The first bit (bit 0) starts at the first falling edge of **SPC** after the falling edge of **CS** while the last bit (bit 15, bit 23, ...) starts at the last falling edge of **SPC** just before the rising edge of **CS**.

**bit 0:** RW bit. When 0, the data DI(7:0) is written into the device. When 1, the data DO(7:0) from the device is read. In latter case, the chip will drive **SDO** at the start of bit 8.

**bit 1-7:** address AD(6:0). This is the address field of the indexed register.

**bit 8-15:** data DI(7:0) (write mode). This is the data that is written into the device (MSb first).

**bit 8-15:** data DO(7:0) (read mode). This is the data that is read from the device (MSb first).

In multiple read/write commands further blocks of 8 clock periods will be added. When the [Section 7.1 CTRL\\_REG1 \(20h\)](#) (IF\_ADD\_INC) bit is '0' the address used to read/write data remains the same for every block. When [Section 7.1 CTRL\\_REG1 \(20h\)](#)(IF\_ADD\_INC) bit is '1' the address used to read/write data is increased at every block.

The function and the behavior of **SDI** and **SDO** remain unchanged.



### 4.2.1 SPI read

Figure 6. SPI read protocol

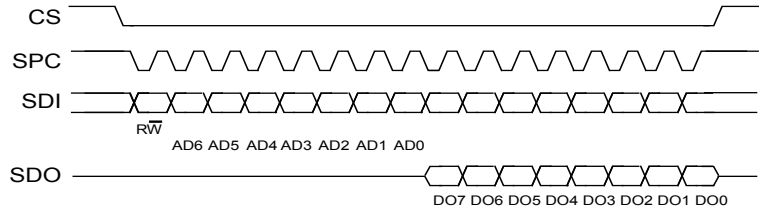

The SPI read command is performed with 16 clock pulses. The multiple byte read command is performed by adding blocks of 8 clock pulses to the previous one.

**bit 0:** READ bit. The value is 1.

**bit 1-7:** address AD(6:0). This is the address field of the indexed register.

**bit 8-15:** data DO(7:0) (read mode). This is the data that will be read from the device (MSb first).

**bit 16-...** : data DO(...-8). Further data in multiple byte reads.

Figure 7. Multiple byte SPI read protocol (2-byte example)

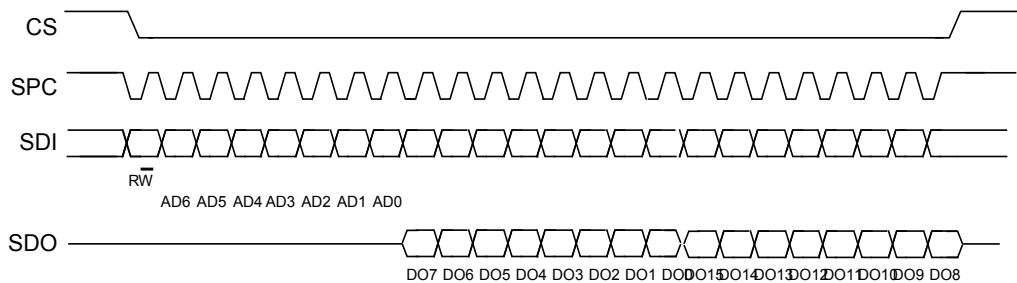

#### 4.2.2 SPI write

Figure 8. SPI write protocol

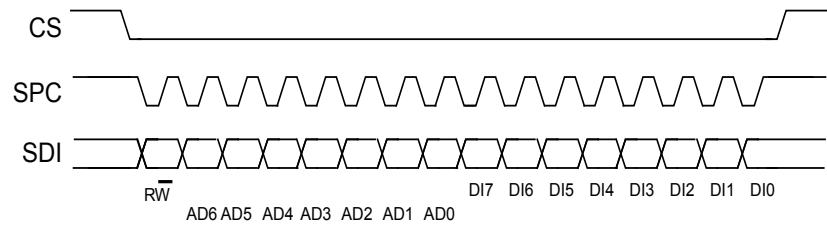

The SPI write command is performed with 16 clock pulses. The multiple byte write command is performed by adding blocks of 8 clock pulses to the previous one.

**bit 0:** WRITE bit. The value is 0.

**bit 1 -7:** address AD(6:0). This is the address field of the indexed register.

**bit 8-15:** data DI(7:0) (write mode). This is the data that is written inside the device (MSb first).

**bit 16-...** : data DI(...-8). Further data in multiple byte writes.

Figure 9. Multiple byte SPI write protocol (2-byte example)

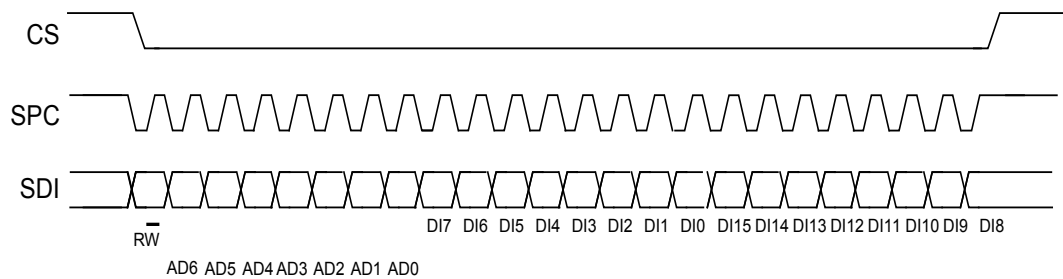

## 5 FIFO

The IIS3DHHHC embeds 32 slots of 16-bit data FIFO for each of the accelerometer's three output channels, X, Y and Z. This allows consistent power saving for the system since the host processor does not need to continuously poll data from the sensor, but it can wake up only when needed and burst the significant data out from the FIFO. This buffer can work accordingly to five different modes: Bypass mode, FIFO mode, Continuous mode, Continuous-to-FIFO mode and Bypass-to-Continuous mode. Each mode is selected by the FMODE [2:0] bits in the [Section 7.11 FIFO\\_CTRL \(2Eh\)](#) register. Programmable FIFO threshold status, FIFO overrun events and the number of unread samples stored are available in the [Section 7.12 FIFO\\_SRC \(2Fh\)](#) register and can be set to generate dedicated interrupts on the INT1 and INT2 pins using the [Section 7.2 INT1\\_CTRL \(21h\)](#) and [Section 7.3 INT2\\_CTRL \(22h\)](#) registers.

[Section 7.12 FIFO\\_SRC \(2Fh\)](#)(FTH) goes to '1' when the number of unread samples ([Section 7.12 FIFO\\_SRC \(2Fh\)](#) (FSS5:0)) is greater than or equal to FTH [4:0] in [Section 7.11 FIFO\\_CTRL \(2Eh\)](#). If [Section 7.11 FIFO\\_CTRL \(2Eh\)](#) (FTH[4:0]) is equal to 0, [Section 7.12 FIFO\\_SRC \(2Fh\)](#)(FTH) goes to '0'.

[Section 7.12 FIFO\\_SRC \(2Fh\)](#)(OVRN) is equal to '1' if a FIFO slot is overwritten.

[Section 7.12 FIFO\\_SRC \(2Fh\)](#)(FSS [5:0]) contains stored data levels of unread samples. When FSS [5:0] is equal to '000000', FIFO is empty. When FSS [5:0] is equal to '100000', FIFO is full and the unread samples are 32.

The FIFO feature is enabled by writing '1' in [Section 7.4 CTRL\\_REG4 \(23h\)](#) (FIFO\_EN).

To guarantee the correct acquisition of data during the switching into and out of FIFO mode, the first sample acquired must be discarded.

### 5.1 Bypass mode

In Bypass mode ([Section 7.11 FIFO\\_CTRL \(2Eh\)](#)(FMODE [2:0]= 000), the FIFO is not operational, no data is collected in FIFO memory, and it remains empty with the only actual sample available in the output registers.

Bypass mode is also used to reset the FIFO when in FIFO mode.

As described in [Figure 10. Bypass mode](#), for each channel only the first address is used. When new data is available the old data is overwritten.

**Figure 10. Bypass mode**

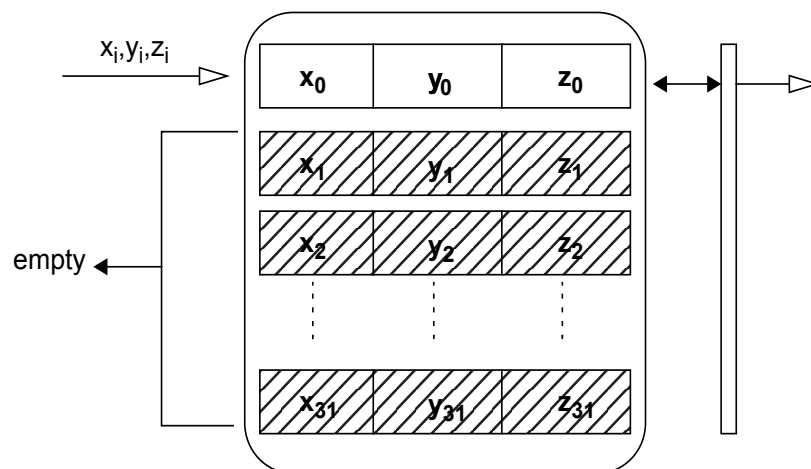

## 5.2 FIFO mode

In FIFO mode (Section 7.11 FIFO\_CTRL (2Eh) (FMODE [2:0] = 001) data from the output channels are stored in the FIFO memory until it is full, when 32 unread samples are stored in memory, data collecting is stopped.

To reset FIFO content, Bypass mode should be selected by writing Section 7.11 FIFO\_CTRL (2Eh) (FMODE [2:0]) to '000'. After this reset command, it is possible to restart FIFO mode, writing Section 7.11 FIFO\_CTRL (2Eh) (FMODE [2:0]) to '001'.

A FIFO threshold interrupt can be enabled (INT1\_OVR bit in Section 7.2 INT1\_CTRL (21h) or INT2\_OVR bit in Section 7.3 INT2\_CTRL (22h)) in order to be raised when the FIFO is filled to the level specified by the FTH[4:0] bits of Section 7.11 FIFO\_CTRL (2Eh).

Figure 11. FIFO mode

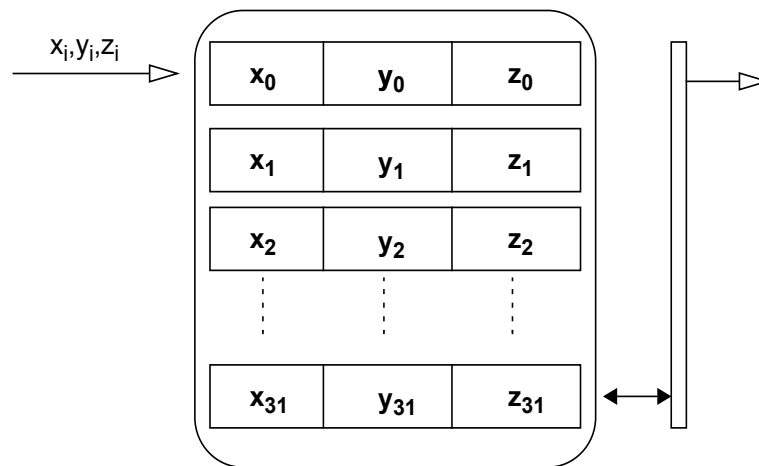

### 5.3 Continuous mode

Continuous mode (Section 7.11 FIFO\_CTRL (2Eh) (FMODE[2:0] = 110) provides a continuous FIFO update: when 32 unread samples are stored in memory, as new data arrives the oldest data is discarded and overwritten by the newer.

A FIFO threshold flag Section 7.12 FIFO\_SRC (2Fh)(FTH) is asserted when the number of unread samples in FIFO is greater than or equal to Section 7.11 FIFO\_CTRL (2Eh)(FTH4:0).

It is possible to route Section 7.12 FIFO\_SRC (2Fh)(FTH) to the INT1 pin by writing the INT1\_FTH bit to '1' in register Section 7.2 INT1\_CTRL (21h) or to the INT2 pin by writing the INT2\_FTH bit to '1' in register Section 7.3 INT2\_CTRL (22h).

A full-flag interrupt can be enabled (Section 7.2 INT1\_CTRL (21h) (INT\_FSS5)= '1' or Section 7.3 INT2\_CTRL (22h) (INT\_FSS5)= '1') when the FIFO becomes saturated and in order to read the contents all at once. If an overrun occurs, the oldest sample in FIFO is overwritten and the OVRN flag in Section 7.12 FIFO\_SRC (2Fh) is asserted.

In order to empty the FIFO before it is full, it is also possible to pull from FIFO the number of unread samples available in Section 7.12 FIFO\_SRC (2Fh) (FSS[5:0]).

Figure 12. Continuous mode

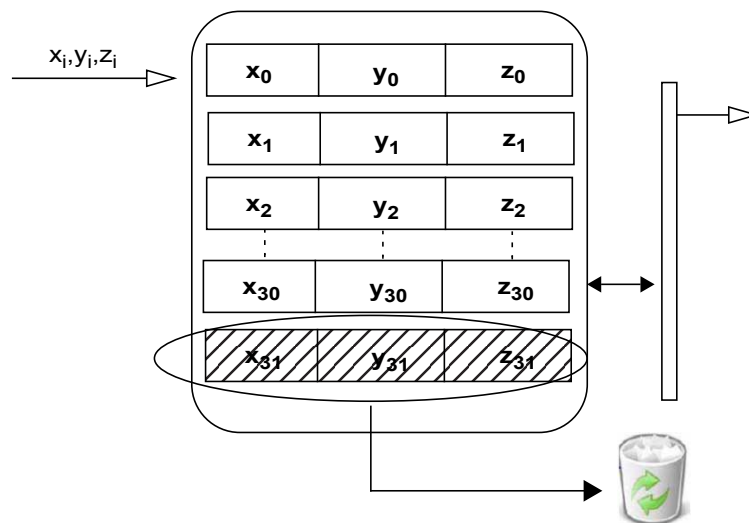

## 5.4 Continuous-to-FIFO mode

In Continuous-to-FIFO mode (Section 7.11 FIFO\_CTRL (2Eh)(FMODE [2:0] = 011), FIFO operates in Continuous mode and FIFO mode starts on the INT1 edge trigger event. When the FIFO is full, data collecting is stopped.

Figure 13. Continuous-to-FIFO mode

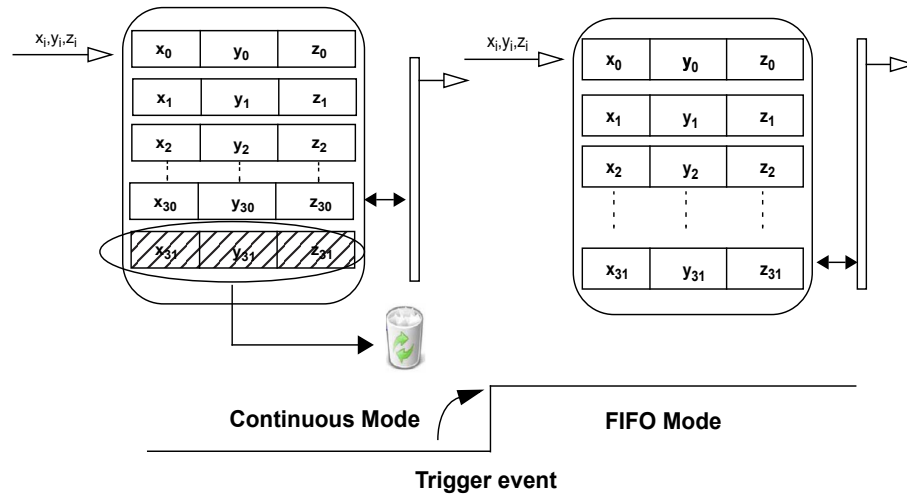
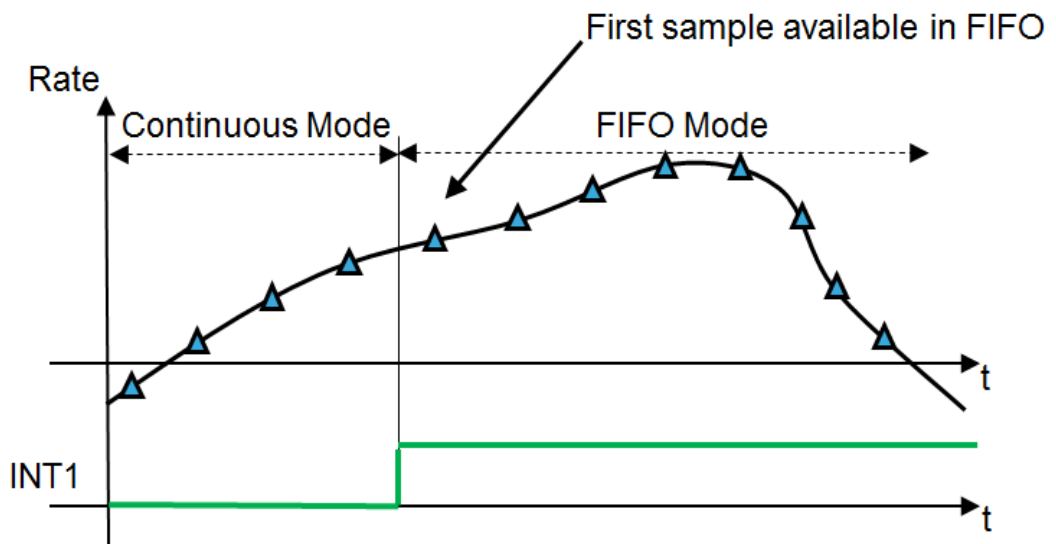

Figure 14. External asynchronous trigger to FIFO for Continuous-to-FIFO mode



## 5.5 Bypass-to-Continuous mode

In Bypass-to-Continuous mode (Section 7.11 FIFO\_CTRL (2Eh)(FMODE[2:0] = '100'), data measurement storage inside FIFO starts in Continuous mode on the INT1 edge trigger event, then the sample that follows the trigger is available in FIFO.

**Figure 15. Bypass-to-Continuous mode**

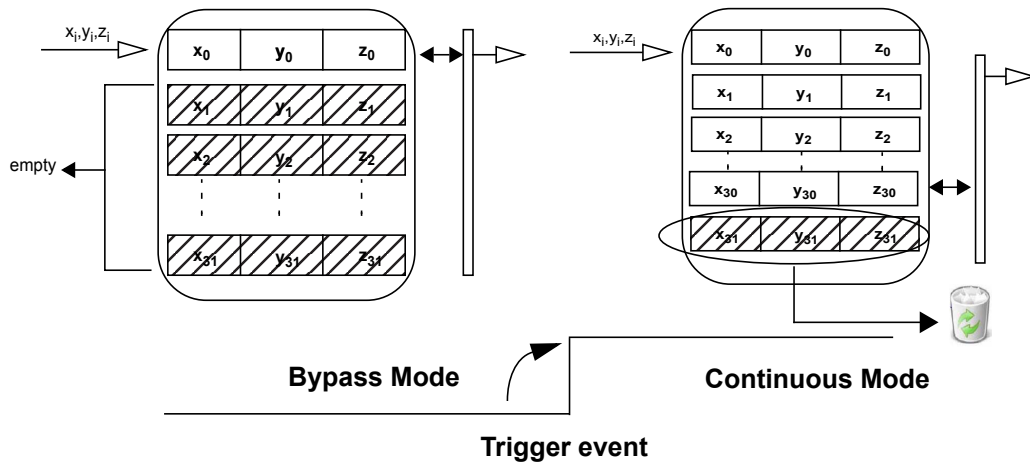

**Figure 16. External asynchronous trigger to FIFO for Bypass-to-Continuous mode**

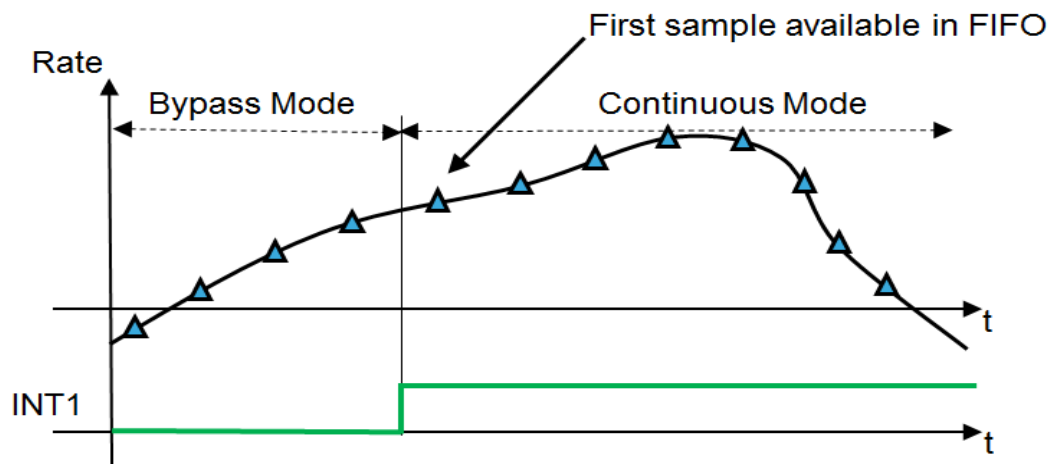

## 6 Register mapping

The table given below provides a list of the 8/16-bit registers embedded in the device and the corresponding addresses.

**Table 7. Register mapping**

Name	Type	Register address		Default	Note
		Hex	Binary		
Reserved	--	00-0E	--	--	Reserved
WHO_AM_I	r	0F	00001111	00010001	
Reserved	--	10-1F	--	--	Reserved
CTRL_REG1	r/w	20	00100000	00000000	
INT1_CTRL	r/w	21	00100001	00000000	
INT2_CTRL	r/w	22	00100010	00000000	
CTRL_REG4	r/w	23	00100011	00000000	
CTRL_REG5	r/w	24	00100100	00000000	
OUT_TEMP_L	r	25	00100101	output	
OUT_TEMP_H	r	26	00100110	output	
STATUS	r	27	00100111	output	
OUT_X_L_XL	r	28	00101000	output	
OUT_X_H_XL	r	29	00101001	output	
OUT_Y_L_XL	r	2A	00101010	output	
OUT_Y_H_XL	r	2B	00101011	output	
OUT_Z_L_XL	r	2C	00101100	output	
OUT_Z_H_XL	r	2D	00101101	output	
FIFO_CTRL	r/w	2E	00101110	00000000	
FIFO_SRC	r	2F	00101111	output	
Reserved	--	30-32	--	--	Reserved

Registers marked as Reserved must not be changed. Writing to those registers may affect the correct behavior of the device.

Their content is automatically restored when the device is powered up.



## 7 Register description

The device contains a set of registers which are used to control its behavior and to retrieve linear acceleration and temperature data. The register addresses, consisting of 7 bits, are used to identify them and to write the data through the serial interface.

### 7.1 CTRL\_REG1 (20h)

Control register 1

**Table 8. CTRL\_REG1 register**

NORM_	IF_ADD_INC	0 <sup>(1)</sup>	0 <sup>(1)</sup>	BOOT	SW_RESET	DRDY_	BDU
MOD_EN						PULSE	

1. These bits must be set to '0' for the correct operation of the device.

**Table 9. CTRL\_REG1 register description**

NORM_MOD_EN	Normal mode enable. Default value: 0 (0: power down; 1: enabled)
IF_ADD_INC	Register address automatically incremented during a multiple byte access with SPI serial interface. Default value: 1 (0: disabled; 1: enabled)
BOOT	Reboot memory content. Default value: 0 (0: normal mode; 1: reboot memory content <sup>(1)</sup> )
SW_RESET	Software reset. Default value: 0 With SW_RESET the values in the writable CTRL registers are changed to the default values. (0: normal mode; 1: reset device) This bit is cleared by hardware at the end of the operation.
DRDY_PULSE	Data-ready on INT1 pin. Default value: 0 (0: DRDY latched; 1: DRDY pulsed, pulse duration is 1/4 ODR)
BDU	Block Data Update. Default value: 0 (0: continuous update; 1: output registers not updated until MSB and LSB read)

1. Boot request is executed as soon as the internal oscillator is turned on. It is possible to set the bit while in power-down mode, in this case it will be served at the next normal mode.

## 7.2 INT1\_CTRL (21h)

INT1 pin control register

**Table 10. INT1\_CTRL register**

INT1_ DRDY	INT1_ BOOT	INT1_ OVR	INT1_ FSS5	INT1_ FTH	INT1_ EXT	0 <sup>(1)</sup>	0 <sup>(1)</sup>
---------------	---------------	--------------	---------------	--------------	--------------	------------------	------------------

1. These bits must be set to '0' for the correct operation of the device.

INT1_DRDY	Accelerometer data ready on INT1 pin. Default value: 0 (0: disabled; 1: enabled)
INT1_BOOT	Boot status available on INT1 pin. Default value: 0 (0: disabled; 1: enabled)
INT1_OVR	Overflow flag on INT1 pin. Default value: 0 (0: disabled; 1: enabled)
INT1_FSS5	FSS5 full FIFO flag on INT1 pin. Default value: 0 (0: disabled; 1: enabled)
INT1_FTH	FIFO threshold flag on INT1 pin. Default value: 0 (0: disabled; 1: enabled)
INT1_EXT	INT1 pin configuration. Default value: 0 It configures the INT1 pad as output for FIFO flags or as external asynchronous input trigger to FIFO. INT2 pad is always available as output for FIFO flags. (0: INT1 as output interrupt; 1: INT1 as input channel)

### 7.3 INT2\_CTRL (22h)

INT2 pin control register

**Table 11. INT2\_CTRL register**

INT2_DRDY	INT2_BOOT	INT2_OVR	INT2_FSS5	INT2_FTH	0 <sup>(1)</sup>	0 <sup>(1)</sup>	0 <sup>(1)</sup>
-----------	-----------	----------	-----------	----------	------------------	------------------	------------------

1. These bits must be set to '0' for the correct operation of the device.

INT2_DRDY	Accelerometer data ready on INT2 pin. Default value: 0 (0: disabled; 1: enabled)
INT2_BOOT	Boot status available on INT2 pin. Default value: 0 (0: disabled; 1: enabled)
INT2_OVR	Overflow flag on INT2 pin. Default value: 0 (0: disabled; 1: enabled)
INT2_FSS5	FSS5 full FIFO flag on INT2 pin. Default value: 0 (0: disabled; 1: enabled)
INT2_FTH	FIFO threshold flag on INT2 pin. Default value: 0 (0: disabled; 1: enabled)

### 7.4 CTRL\_REG4 (23h)

Control register 4

**Table 12. CTRL\_REG4 register**

DSP_LP_ TYPE	DSP_BW_ SEL	ST2	ST1	PP_OD_ INT2	PP_OD_ INT1	FIFO_EN	OFF_TCOMP_ _EN
-----------------	----------------	-----	-----	----------------	----------------	---------	-------------------

**Table 13. CTRL\_REG4 register description**

DSP_LP_TYPE	Digital filtering selection. Default value: 0 (0: FIR Linear Phase; 1: IIR Nonlinear Phase)
DSP_BW_SEL	User-selectable bandwidth. Default value: 0 (0: 440 Hz typ.; 1: 235 Hz typ.)
ST [2:1]	Self-test enable. Default value: 00 (00: Self-test disabled; Other: See <a href="#">Table 14. Self-test mode selection</a> )
PP_OD_INT2	Push-pull/open drain selection on INT2 pin. Default value: 0 (0: push-pull mode; 1: open drain mode)
PP_OD_INT1	Push-pull/open drain selection on INT1 pin. Default value: 0 (0: push-pull mode; 1: open drain mode)
FIFO_EN	FIFO memory enable. Default value: 0 (0: disabled; 1: enabled)
OFF_TCOMP_EN	Offset temperature compensation enable. Default value: 0 (0: disabled; 1: enabled)

**Table 14. Self-test mode selection**

ST2	ST1	Self-test mode
0	0	Normal mode
0	1	Positive sign self-test
1	0	Negative sign self-test
1	1	Not allowed

## 7.5 CTRL\_REG5 (24h)

Control register 5

**Table 15. CTRL\_REG5 register**

0 <sup>(1)</sup>	0 <sup>(1)</sup>	0 <sup>(1)</sup>	0 <sup>(1)</sup>	0 <sup>(1)</sup>	0 <sup>(1)</sup>	0 <sup>(1)</sup>	FIFO_SPI_ HS_ON
------------------	------------------	------------------	------------------	------------------	------------------	------------------	--------------------

1. These bits must be set to '0' for correct operation of the device.

**Table 16. CTRL\_REG5 register description**

FIFO_SPI_HS_ON	Enables the SPI high speed configuration for the FIFO block that is used to guarantee a minimum duration of the window in which writing operation of RAM output is blocked. This bit is recommended for SPI clock frequencies higher than 6 MHz. Default value: 0 (0: not enabled; 1: enabled)
----------------	---

## 7.6 OUT\_TEMP\_L (25h), OUT\_TEMP\_H (26h)

Temperature data output register. L and H registers together express a 16-bit word in two's complement left-justified.

**Table 17. OUT\_TEMP\_L register**

Temp3	Temp2	Temp1	Temp0	0	0	0	0
-------	-------	-------	-------	---	---	---	---

**Table 18. OUT\_TEMP\_H register**

Temp11	Temp10	Temp9	Temp8	Temp7	Temp6	Temp5	Temp4
--------	--------	-------	-------	-------	-------	-------	-------

**Table 19. OUT\_TEMP register description**

Temp [11:0]	Temperature sensor output data. The value is expressed as two's complement sign. 0 LSB represents T=25 °C ambient.
-------------	--

## 7.7 STATUS (27h)

Status register (r)

**Table 20. Status register**

ZYXOR	ZOR	YOR	XOR	ZYXDA	ZDA	YDA	XDA
-------	-----	-----	-----	-------	-----	-----	-----

**Table 21. Status register description**

ZYXOR	Logic OR of the single X-, Y- and Z-axis data overrun. Default value: 0 (0: no overrun has occurred; 1: a new set of data has overwritten the previous set)
ZOR	Z-axis data overrun. Default value: 0 (0: no overrun has occurred; 1: new data for the Z-axis has overwritten the previous data)
YOR	Y-axis data overrun. Default value: 0 (0: no overrun has occurred; 1: new data for the Y-axis has overwritten the previous data)
XOR	X-axis data overrun. Default value: 0 (0: no overrun has occurred; 1: new data for the X-axis has overwritten the previous data)
ZYXDA	Logic AND of the single X-, Y- and Z-axis new data available. Default value: 0 (0: a new set of data is not yet available; 1: a new set of data is available)
ZDA	Z-axis new data available. Default value: 0 (0: new data for the Z-axis is not yet available; 1: new data for the Z-axis is available)
YDA	Y-axis new data available. Default value: 0 (0: new data for the Y-axis is not yet available; 1: new data for the Y-axis is available)
XDA	X-axis new data available. Default value: 0 (0: new data for the X-axis is not yet available; 1: new data for the X-axis is available)

## 7.8 OUT\_X (28h - 29h)

Linear acceleration sensor X-axis output register. The value is expressed as a 16-bit word in two's complement.

## 7.9 OUT\_Y (2Ah - 2Bh)

Linear acceleration sensor Y-axis output register. The value is expressed as a 16-bit word in two's complement.

## 7.10 OUT\_Z (2Ch - 2Dh)

Linear acceleration sensor Z-axis output register. The value is expressed as a 16-bit word in two's complement.

## 7.11 FIFO\_CTRL (2Eh)

FIFO control register

**Table 22. FIFO\_CTRL register**

FMODE2	FMODE1	FMODE0	FTH4	FTH3	FTH2	FTH1	FTH0
--------	--------	--------	------	------	------	------	------

**Table 23. FIFO\_CTRL register description**

FMODE [2:0]	FIFO mode selection bits. Default value: 000 For further details refer to <a href="#">Table 24. FIFO mode selection</a> .
FTH [4:0]	FIFO threshold level setting. Default value: 0 0000

**Table 24. FIFO mode selection**

FMODE2	FMODE1	FMODE0	Mode
0	0	0	Bypass mode. FIFO turned off
0	0	1	FIFO mode. Stops collecting data when FIFO is full.
0	1	0	Reserved
0	1	1	Continuous mode until trigger is asserted, then FIFO mode.
1	0	0	Bypass mode until trigger is asserted, then Continuous mode.
1	0	1	Reserved
1	1	0	Continuous mode. If the FIFO is full, the new sample overwrites the older sample.
1	1	1	Reserved

## 7.12 FIFO\_SRC (2Fh)

FIFO status register

**Table 25. FIFO\_SRC register**

FTH	OV RN	FSS5	FSS4	FSS3	FSS2	FSS1	FSS0
FTH	FIFO threshold status. (0: FIFO filling is lower than threshold level; 1: FIFO filling is equal to or higher than the threshold level)						
OV RN	FIFO overrun status. (0: FIFO is not completely filled; 1: FIFO is completely filled and at least one sample has been overwritten) For further details refer to <a href="#">Table 26. FIFO_SRC example: OVR/FSS details</a> .						
FSS [5:0]	Number of unread samples stored in FIFO. (000000: FIFO empty; 100000: FIFO full, 32 unread samples) For further details refer to <a href="#">Table 26. FIFO_SRC example: OVR/FSS details</a> .						

**Table 26. FIFO\_SRC example: OVR/FSS details**

FTH	OV RN	FSS5	FSS4	FSS3	FSS2	FSS1	FSS0	Description
0	0	0	0	0	0	0	0	FIFO empty
-- (1)	0	0	0	0	0	0	1	1 unread sample
...								
--(1)	0	1	0	0	0	0	0	32 unread samples
0(1)	1	1	0	0	0	0	0	At least one sample has been overwritten

1. When the number of unread samples in FIFO is equal to or greater than the threshold level set in register [Section 7.11 FIFO\\_CTRL \(2Eh\)](#), the FTH value is '1'.

The FSS is the FIFO stored data level of the unread samples. When it is equal to FTH, all data available in FIFO are read without additional read operations.

The INT output is high when the number of samples to read is equal to or greater than FTH.

Figure 17. Continuous mode: FTH/FSS details

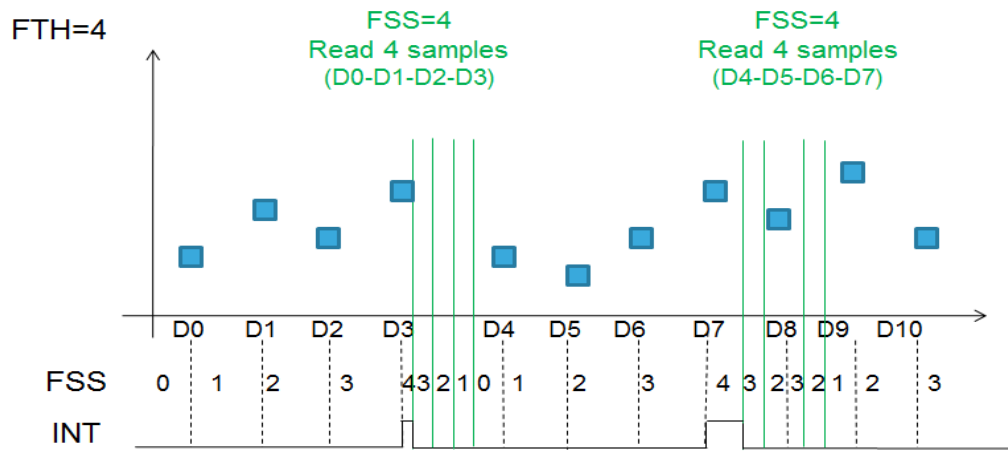



## 8 Package information

In order to meet environmental requirements, ST offers these devices in different grades of ECOPACK® packages, depending on their level of environmental compliance. ECOPACK® specifications, grade definitions and product status are available at: [www.st.com](http://www.st.com). ECOPACK® is an ST trademark.

### 8.1 LGA-16 package information

Figure 18. Ceramic cavity LGA-16: package outline and mechanical data

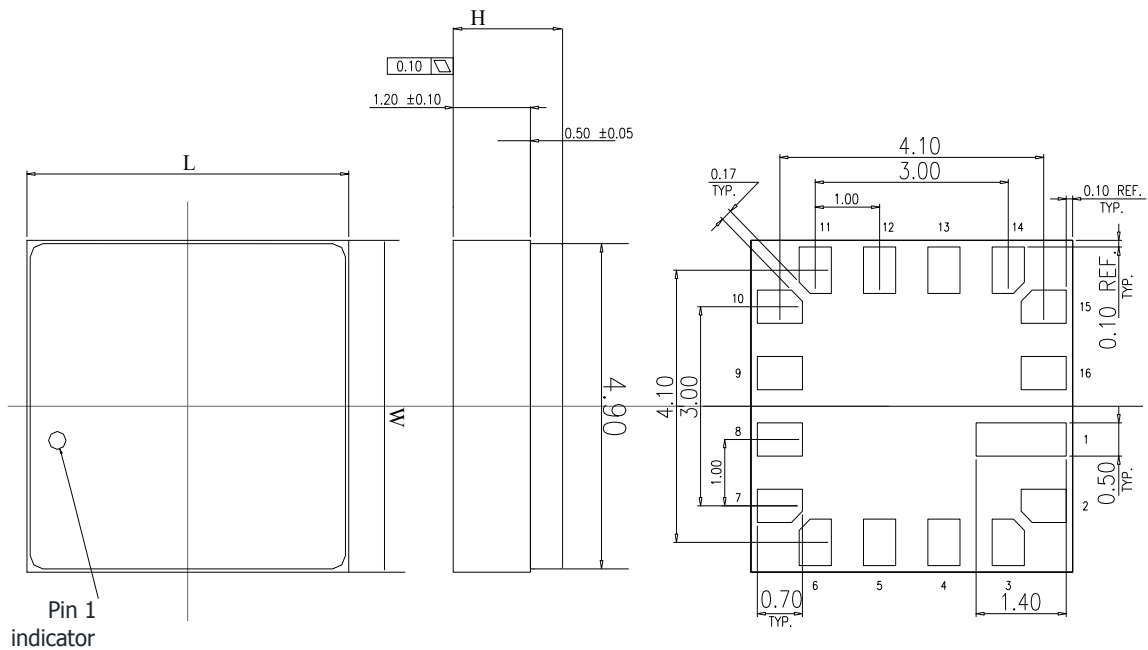

8535893\_A

Note: Top and bottom view: dimensions are expressed in mm

Table 27. Outer dimensions

ITEM	Dimension [mm]	Tolerance [mm]
Length [L]	5	±0.15
Width [W]	5	±0.15
Height [H]	1.7 typ	±0.15
Pad size	0.7 x 0.5	±0.15

Note: General tolerance is ±0.1 mm unless otherwise specified

## Revision history

**Table 28. Document revision history**

Date	Revision	Changes
02-Oct-2017	1	Initial release
19-Jan-2018	2	Added information concerning 10-year longevity commitment Updated <a href="#">Figure 2. Recommended power-up sequence</a>

## Contents

<b>1</b>	<b>Pin description</b>	<b>2</b>
<b>2</b>	<b>Mechanical and electrical specifications</b>	<b>3</b>
2.1	Mechanical characteristics	3
2.2	Electrical characteristics	4
2.2.1	Recommended power-up sequence	4
2.3	Temperature sensor characteristics	5
<b>3</b>	<b>Absolute maximum ratings</b>	<b>6</b>
<b>4</b>	<b>Communication interface characteristics</b>	<b>7</b>
4.1	SPI - serial peripheral interface	7
4.2	SPI bus interface	8
4.2.1	SPI read	9
4.2.2	SPI write	10
<b>5</b>	<b>FIFO</b>	<b>11</b>
5.1	Bypass mode	11
5.2	FIFO mode	11
5.3	Continuous mode	13
5.4	Continuous-to-FIFO mode	14
5.5	Bypass-to-Continuous mode	15
<b>6</b>	<b>Register mapping</b>	<b>16</b>
<b>7</b>	<b>Register description</b>	<b>17</b>
7.1	CTRL_REG1 (20h)	17
7.2	INT1_CTRL (21h)	18
7.3	INT2_CTRL (22h)	19
7.4	CTRL_REG4 (23h)	19
7.5	CTRL_REG5 (24h)	20
7.6	OUT_TEMP_L (25h), OUT_TEMP_H (26h)	20
7.7	STATUS (27h)	21
7.8	OUT_X (28h - 29h)	21
7.9	OUT_Y (2Ah - 2Bh)	21

---

7.10	OUT_Z (2Ch - 2Dh).....	21
7.11	FIFO_CTRL (2Eh).....	22
7.12	FIFO_SRC (2Fh).....	23
<b>8</b>	<b>Package information.....</b>	<b>25</b>
8.1	LGA-16 package information.....	25
	<b>Revision history.....</b>	<b>26</b>

## List of tables

<b>Table 1.</b>	Pin description . . . . .	2
<b>Table 2.</b>	Mechanical characteristics . . . . .	3
<b>Table 3.</b>	Electrical characteristics . . . . .	4
<b>Table 4.</b>	Temperature sensor characteristics . . . . .	5
<b>Table 5.</b>	Absolute maximum ratings . . . . .	6
<b>Table 6.</b>	SPI slave timing values. . . . .	7
<b>Table 7.</b>	Register mapping. . . . .	16
<b>Table 8.</b>	CTRL_REG1 register . . . . .	17
<b>Table 9.</b>	CTRL_REG1 register description . . . . .	17
<b>Table 10.</b>	INT1_CTRL register . . . . .	18
<b>Table 11.</b>	INT2_CTRL register . . . . .	19
<b>Table 12.</b>	CTRL_REG4 register . . . . .	19
<b>Table 13.</b>	CTRL_REG4 register description . . . . .	19
<b>Table 14.</b>	Self-test mode selection . . . . .	20
<b>Table 15.</b>	CTRL_REG5 register . . . . .	20
<b>Table 16.</b>	CTRL_REG5 register description . . . . .	20
<b>Table 17.</b>	OUT_TEMP_L register . . . . .	20
<b>Table 18.</b>	OUT_TEMP_H register. . . . .	20
<b>Table 19.</b>	OUT_TEMP register description. . . . .	20
<b>Table 20.</b>	Status register . . . . .	21
<b>Table 21.</b>	Status register description. . . . .	21
<b>Table 22.</b>	FIFO_CTRL register. . . . .	22
<b>Table 23.</b>	FIFO_CTRL register description. . . . .	22
<b>Table 24.</b>	FIFO mode selection . . . . .	22
<b>Table 25.</b>	FIFO_SRC register . . . . .	23
<b>Table 26.</b>	FIFO_SRC example: OVR/FSS details . . . . .	23
<b>Table 27.</b>	Outer dimensions. . . . .	25
<b>Table 28.</b>	Document revision history . . . . .	26

## List of figures

<b>Figure 1.</b>	Pin connections . . . . .	2
<b>Figure 2.</b>	Recommended power-up sequence . . . . .	4
<b>Figure 4.</b>	SPI slave timing diagram . . . . .	7
<b>Figure 5.</b>	Read and write protocol . . . . .	8
<b>Figure 6.</b>	SPI read protocol . . . . .	9
<b>Figure 7.</b>	Multiple byte SPI read protocol (2-byte example). . . . .	9
<b>Figure 8.</b>	SPI write protocol . . . . .	10
<b>Figure 9.</b>	Multiple byte SPI write protocol (2-byte example) . . . . .	10
<b>Figure 10.</b>	Bypass mode . . . . .	11
<b>Figure 11.</b>	FIFO mode . . . . .	12
<b>Figure 12.</b>	Continuous mode . . . . .	13
<b>Figure 13.</b>	Continuous-to-FIFO mode . . . . .	14
<b>Figure 14.</b>	External asynchronous trigger to FIFO for Continuous-to-FIFO mode . . . . .	14
<b>Figure 15.</b>	Bypass-to-Continuous mode . . . . .	15
<b>Figure 16.</b>	External asynchronous trigger to FIFO for Bypass-to-Continuous mode . . . . .	15
<b>Figure 17.</b>	Continuous mode: FTH/FSS details. . . . .	24
<b>Figure 18.</b>	Ceramic cavity LGA-16: package outline and mechanical data . . . . .	25

**IMPORTANT NOTICE – PLEASE READ CAREFULLY**

STMicroelectronics NV and its subsidiaries (“ST”) reserve the right to make changes, corrections, enhancements, modifications, and improvements to ST products and/or to this document at any time without notice. Purchasers should obtain the latest relevant information on ST products before placing orders. ST products are sold pursuant to ST’s terms and conditions of sale in place at the time of order acknowledgement.

Purchasers are solely responsible for the choice, selection, and use of ST products and ST assumes no liability for application assistance or the design of Purchasers’ products.

No license, express or implied, to any intellectual property right is granted by ST herein.

Resale of ST products with provisions different from the information set forth herein shall void any warranty granted by ST for such product.

ST and the ST logo are trademarks of ST. All other product or service names are the property of their respective owners.

Information in this document supersedes and replaces information previously supplied in any prior versions of this document.

© 2018 STMicroelectronics – All rights reserved