

N ATTENUATOR
5 DB 2 GHZ 2W

R412.705.000
Series : **ATTENUATOR**

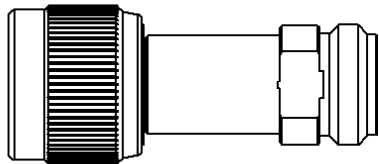

SCALE 1/1

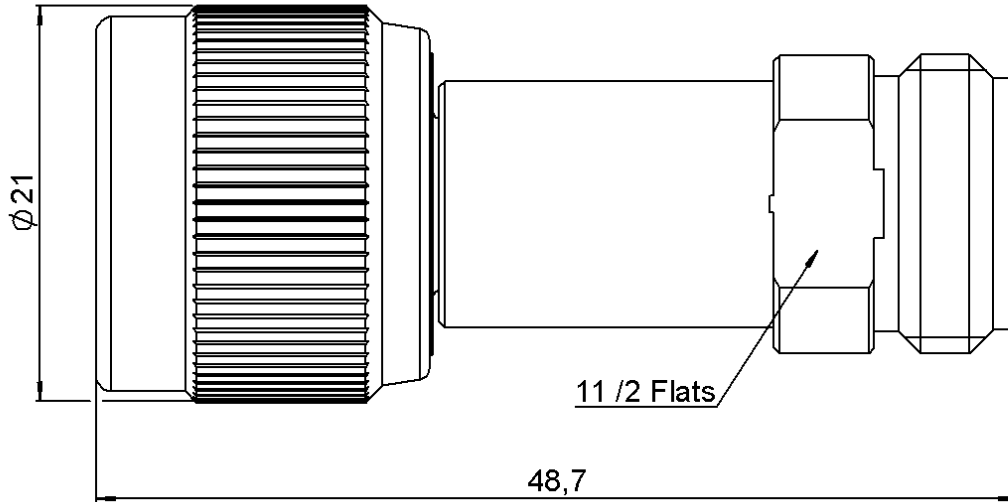

All dimensions are in mm.



COMPONENTS	MATERIALS	PLATING(μm)
BODY	BRASS	NICKEL 5
MALE CENTER CONTACT	BERYLLIUM COPPER	GOLD 2.5 OVER NICKEL 1
FEMALE CENTER CONTACT	BERYLLIUM COPPER	GOLD 2.5 OVER NICKEL 1
OUTER CONTACT	BRASS	NICKEL 2
INSULATOR	PTFE	
GASKET	SILICONE RUBBER	
SUBSTRATE	ALUMINA	
RESISTOR	Thin film	
OTHERS PARTS		

Issue : 0821 F

In the effort to improve our products, we reserve the right to make changes judged to be necessary.



N ATTENUATOR
5 DB 2 GHZ 2W

R412.705.000
 Series : ATTENUATOR

ELECTRICAL CHARACTERISTICS

Frequency (GHz) DC - 2
 V.S.W.R (≤) 1.15
 Deviation(±dB) 0.35

Operating Frequency Range	DC - 2	GHz
Impedance	50	Ω
Nominal Attenuation	5	dB
Peak power at 25°C (1μs, 1%)	100	W
Average power at 25°C	2	W (Free Air Cooled)
		W (Conduction Cooled)

MECHANICAL CHARACTERISTICS

Connectors	N	Male Female	MIL-C 39012
Weight	59,9700 g		

ENVIRONMENTAL CHARACTERISTICS

Operating temperature range	-55 /+125 °C
Storage temperature range	-55 /+125 °C

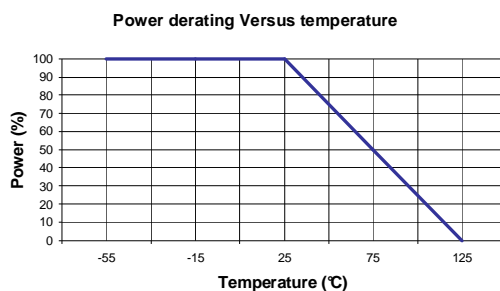

SPECIFICATION

OTHER CHARACTERISTICS

Issue : 0821 F

In the effort to improve our products, we reserve the right to make changes judged to be necessary.

