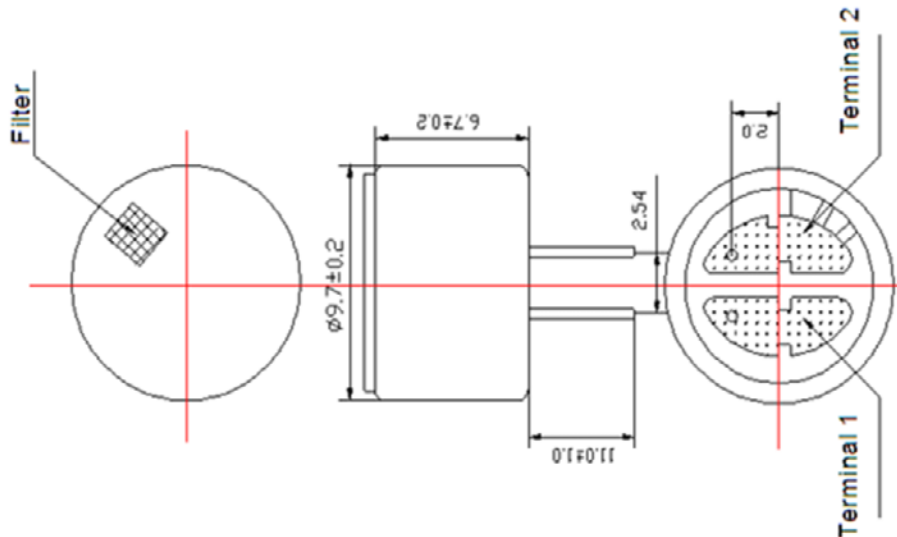

Sales Outline DrawingRevision **A****Specifications:**

Sensitivity Range	-46 ± 2 dB $R_L = 2.2$ k Ω $V_s = 4.5$ v (1 kHz 0 dB = 1 v/Pa)
Impedance	Max. 2.2k Ω 1 kHz ($R_L = 2.2$ k Ω)
Frequency	50 - 20000 Hz
Current Consumption	Max 0.5 mA
Operating Voltage Range	1.0 – 10 V
Max SPL (dB)	115 dB
S/N Ration	More than 58 dB
Sensitivity Reduction	4.5 –3.0V Variation less than 3 dB
Storage Condition	-30 ~ +70°C
Operating Condition	-20 ~ +60°C
Weight (g)	0.8
Options	For other options contact factory

Dimensions: (units: mm)

ROHS Compliant

**Schematic Diagram:**