

### Features

- Black case enhances contrast ratio.
- Wide viewing angle.
- High reliability life measured in years.
- Moisture sensitivity level : level 3.
- Housing material: PPA.
- Housing UL rating : 94V-0.
- High temperature resistant housing.
- High glass transition temperature epoxy.
- RoHS compliant.

### Description

The Yellow source color devices are made with Gallium Arsenide Phosphide on Gallium Phosphide Yellow Light Emitting Diode.

### Package Dimensions

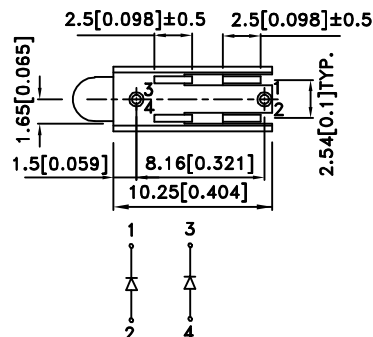
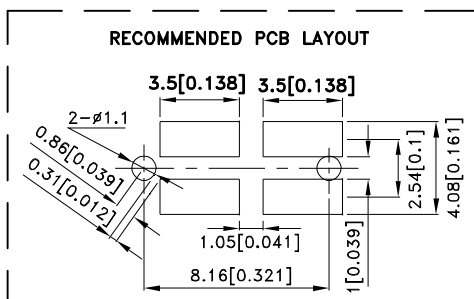
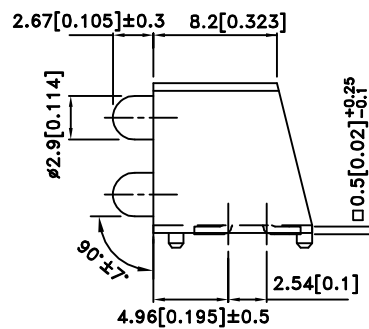
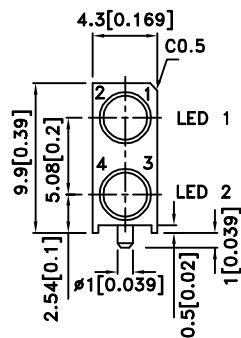

#### Notes:

1. All dimensions are in millimeters (inches).
2. Tolerance is ±0.25(0.01") unless otherwise noted.
3. The specifications, characteristics and technical data described in the datasheet are subject to change without prior notice.



## Selection Guide

Part No.	Dice	Lens Type	Iv (mcd) [2] @ 10mA		Viewing Angle [1]
			Min.	Typ.	2θ1/2
WP7104ALUP/2YD-0L	Yellow (GaAsP/GaP)	Yellow Diffused	8	15	40°

Notes:

1. θ1/2 is the angle from optical centerline where the luminous intensity is 1/2 of the optical peak value.
2. Luminous intensity/ luminous Flux: +/-15%.
3. Luminous intensity value is traceable to the CIE127-2007 compliant national standards.

## Electrical / Optical Characteristics at TA=25°C

Symbol	Parameter	Device	Typ.	Max.	Units	Test Conditions
λ <sub>peak</sub>	Peak Wavelength	Yellow	590		nm	I <sub>F</sub> =20mA
λ <sub>D</sub> [1]	Dominant Wavelength	Yellow	588		nm	I <sub>F</sub> =20mA
Δλ <sub>1/2</sub>	Spectral Line Half-width	Yellow	35		nm	I <sub>F</sub> =20mA
C	Capacitance	Yellow	20		pF	V <sub>F</sub> =0V;f=1MHz
V <sub>F</sub> [2]	Forward Voltage	Yellow	2.1	2.5	V	I <sub>F</sub> =20mA
I <sub>R</sub>	Reverse Current	Yellow		10	uA	V <sub>R</sub> =5V

Notes:

1. Wavelength: +/-1nm.
2. Forward Voltage: +/-0.1V.
3. Wavelength value is traceable to the CIE127-2007 compliant national standards.

## Absolute Maximum Ratings at TA=25°C

Parameter	Yellow	Units
Power dissipation	75	mW
DC Forward Current	30	mA
Peak Forward Current [1]	140	mA
Reverse Voltage	5	V
Operating Temperature	-40°C To +85°C	
Storage Temperature	-40°C To +85°C	

Note:

1. 1/10 Duty Cycle, 0.1ms Pulse Width.

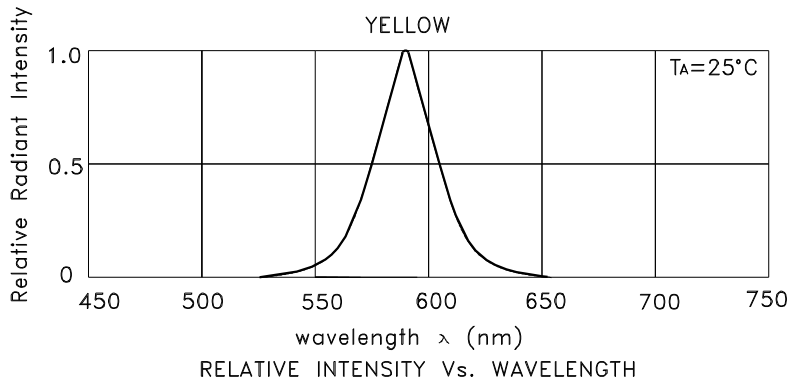

Yellow

WP7104ALUP/2YD-0L

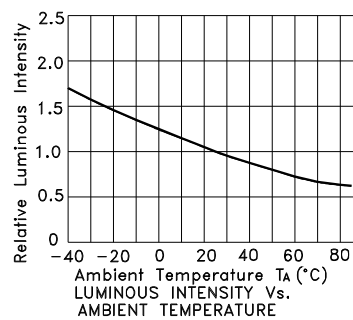

## WP7104ALUP/2YD-0L

Reflow Soldering Profile For Lead-free SMT Process.

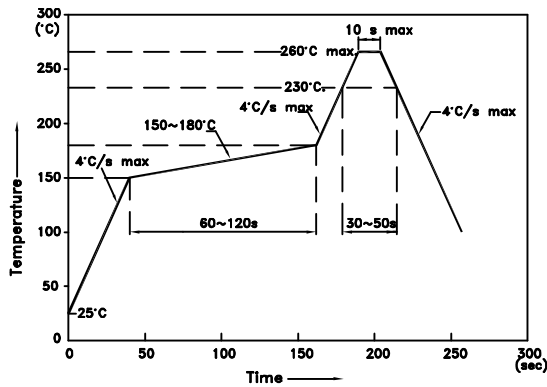

NOTES:

1. We recommend the reflow temperature 245°C(+/-5°C). The maximum soldering temperature should be limited to 260°C.
2. Don't cause stress to the epoxy resin while it is exposed to high temperature.
3. No more than once.

### Tape Dimensions (Units : mm)

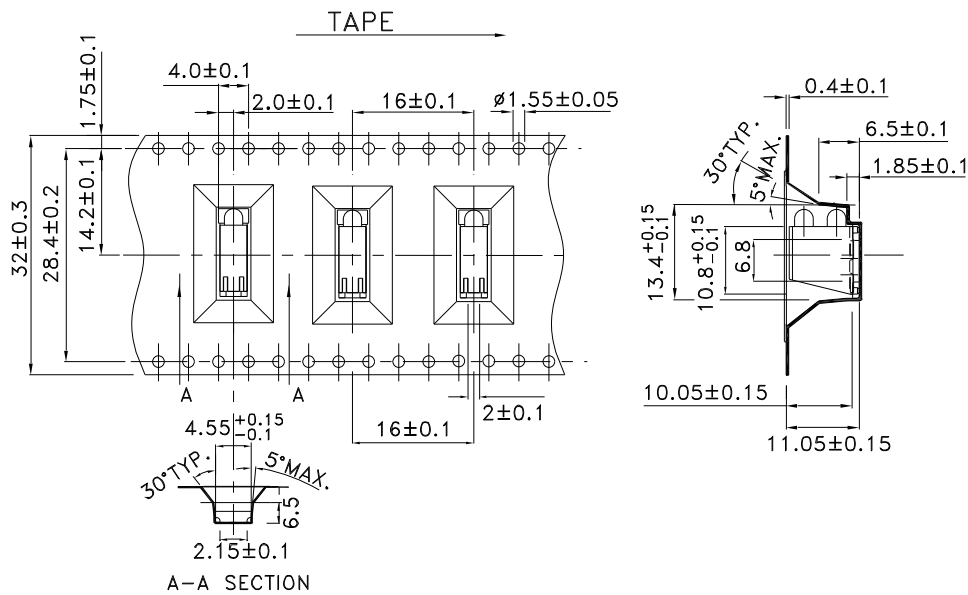

**PACKING & LABEL SPECIFICATIONS**

**WP7104ALUP/2YD-0L**

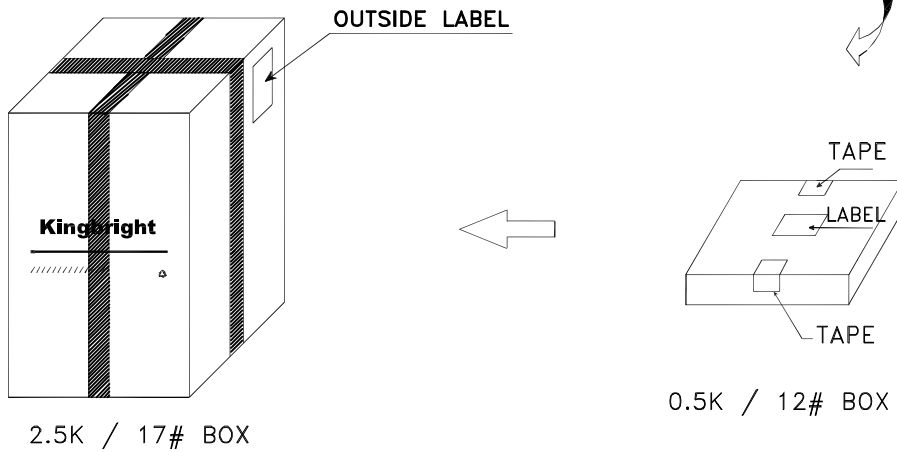
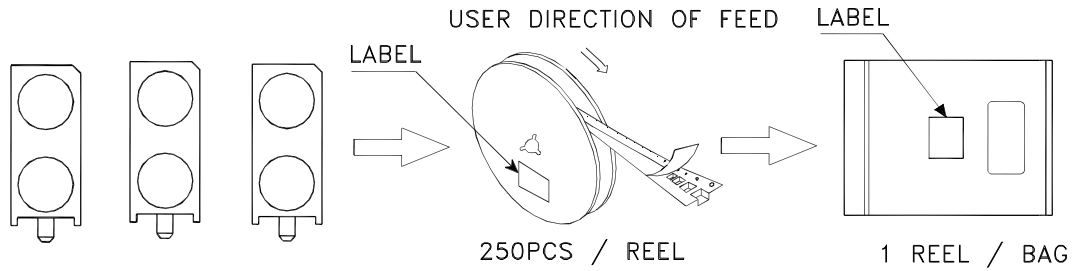

<b>Kingbright</b>				
P/NO: WP7104ALUPxxx				
QTY: 250 pcs	Q.C.			
S/N: XXXX	<table border="1"> <tr> <td>Q C</td> </tr> <tr> <td>XX XX XXXX</td> </tr> <tr> <td>PASSED</td> </tr> </table>	Q C	XX XX XXXX	PASSED
Q C				
XX XX XXXX				
PASSED				
CODE: XXX				
LOT NO:				
 xxxxxxxxxxxxxxxxxxxxxxxxxxxx				
RoHS Compliant				

## PRECAUTIONS

1. A moisture barrier bag (MBB) containing LEDs shall be kept in an environment with temperature below 40°C and humidity below 90% RH. A MBB shall be kept sealed until the LEDs contained in that bag are to be used immediately. Storage in an environment with temperature 5~30°C and humidity below 60% RH.
2. After a MBB has been opened, all LEDs contained in that bag shall complete soldering process within according to the conditions listed on the Kingbright MBB.
3. If the 10% spot of a humidity indicator card (HIC) indicates wet, LEDs shall be baked according to the conditions listed on the Kingbright MBB.
4. During soldering, component covers and holders should leave clearance to avoid placing damaging stress on the LED during soldering.

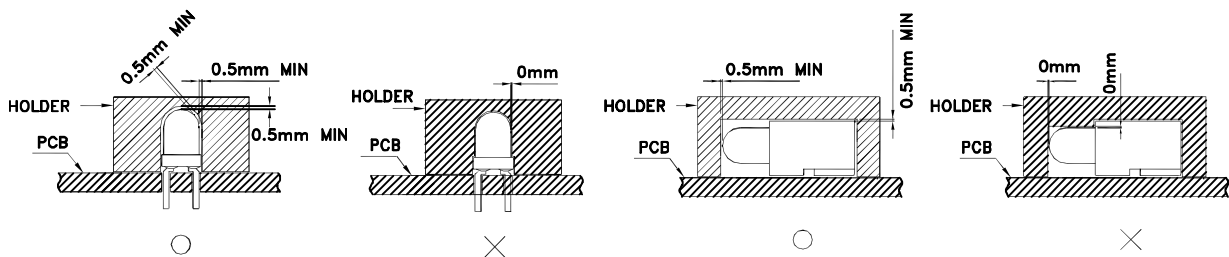

5. The tip of the soldering iron should never touch the lens epoxy.
6. After soldering, allow at least three minutes for the component to cool to room temperature before further operations.
7. If the LED will undergo multiple soldering passes or face other processes where the part may be subjected to intense heat, please check with Kingbright for compatibility.

All design applications should refer to Kingbright application notes available at <http://www.KingbrightUSA.com/ApplicationNotes>