

MMBT6521LT1G, SMMBT6521LT1G

Amplifier Transistor

NPN Silicon

Features

- AEC-Q101 Qualified and PPAP Capable
- S Prefix for Automotive and Other Applications Requiring Unique Site and Control Change Requirements
- These Devices are Pb-Free, Halogen Free/BFR Free and are RoHS Compliant*

MAXIMUM RATINGS

Rating	Symbol	Value	Unit
Collector-Emitter Voltage	V_{CEO}	25	Vdc
Collector-Base Voltage	V_{CBO}	40	Vdc
Emitter-Base Voltage	V_{EBO}	4.0	Vdc
Collector Current — Continuous	I_C	100	mAdc

THERMAL CHARACTERISTICS

Characteristic	Symbol	Max	Unit
Total Device Dissipation FR-5 Board (Note 1) @ $T_A = 25^\circ\text{C}$ Derate above 25°C	P_D	225 1.8	mW mW/ $^\circ\text{C}$
Thermal Resistance, Junction-to-Ambient	$R_{\theta JA}$	556	$^\circ\text{C}/\text{W}$
Total Device Dissipation Alumina Substrate, (Note 2) @ $T_A = 25^\circ\text{C}$ Derate above 25°C	P_D	300 2.4	mW mW/ $^\circ\text{C}$
Thermal Resistance, Junction-to-Ambient	$R_{\theta JA}$	417	$^\circ\text{C}/\text{W}$
Junction and Storage Temperature	T_J, T_{stg}	-55 to +150	$^\circ\text{C}$

Stresses exceeding Maximum Ratings may damage the device. Maximum Ratings are stress ratings only. Functional operation above the Recommended Operating Conditions is not implied. Extended exposure to stresses above the Recommended Operating Conditions may affect device reliability.

1. FR-5 = $1.0 \times 0.75 \times 0.062$ in.
2. Alumina = $0.4 \times 0.3 \times 0.024$ in. 99.5% alumina.

*For additional information on our Pb-Free strategy and soldering details, please download the ON Semiconductor Soldering and Mounting Techniques Reference Manual, SOLDERRM/D.



ON Semiconductor®

<http://onsemi.com>

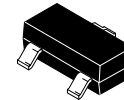

SOT-23 (TO-236)
CASE 318-08
STYLE 6

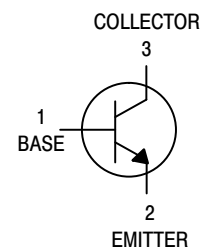

MARKING DIAGRAM

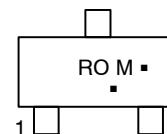

RO = Specific Device Code
M = Date Code*
■ = Pb-Free Package

(Note: Microdot may be in either location)

*Date Code orientation and/or overbar may vary depending upon manufacturing location.

ORDERING INFORMATION

Device	Package	Shipping†
MMBT6521LT1G	SOT-23 (Pb-Free)	3,000 / Tape & Reel
SMMBT6521LT1G	SOT-23 (Pb-Free)	3,000 / Tape & Reel

†For information on tape and reel specifications, including part orientation and tape sizes, please refer to our Tape and Reel Packaging Specification Brochure, BRD8011/D.

MMBT6521LT1G, SMMBT6521LT1G

ELECTRICAL CHARACTERISTICS (T_A = 25°C unless otherwise noted)

Characteristic	Symbol	Min	Max	Unit
OFF CHARACTERISTICS				
Collector - Emitter Breakdown Voltage (I _C = 0.5 mA, I _B = 0)	V _{(BR)CEO}	25	-	Vdc
Emitter - Base Breakdown Voltage (I _E = 10 μA, I _C = 0)	V _{(BR)EBO}	4.0	-	Vdc
Collector Cutoff Current (V _{CB} = 30 Vdc, I _E = 0)	I _{CBO}	-	0.5	μAdc
Emitter Cutoff Current (V _{EB} = 5.0 Vdc, I _C = 0)	I _{EBO}	-	10	nAdc
ON CHARACTERISTICS				
DC Current Gain (I _C = 100 μAdc, V _{CE} = 10 Vdc) (I _C = 2.0 mA, V _{CE} = 10 Vdc)	h _{FE}	150 300	- 600	-
Collector - Emitter Saturation Voltage (I _C = 50 mA, I _B = 5.0 mA)	V _{CE(sat)}	-	0.5	Vdc
SMALL-SIGNAL CHARACTERISTICS				
Output Capacitance (V _{CB} = 10 Vdc, I _E = 0, f = 1.0 MHz)	C _{obo}	-	3.5	pF
Noise Figure (I _C = 10 μAdc, V _{CE} = 5.0 Vdc, Power Bandwidth = 15.7 kHz, 3.0 dB points @ = 10 Hz and 10 kHz)	NF	-	3.0	dB

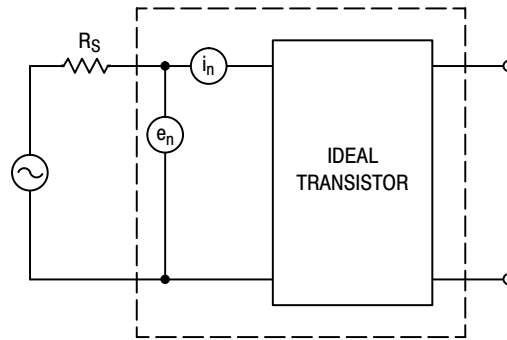

Figure 1. Transistor Noise Model

EQUIVALENT SWITCHING TIME TEST CIRCUITS

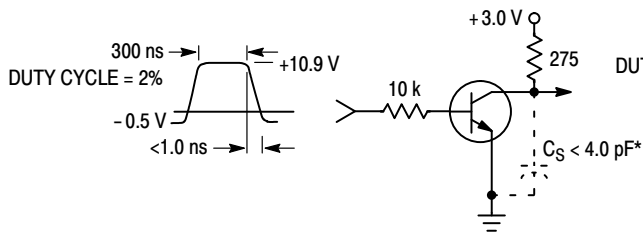

Figure 2. Turn-On Time

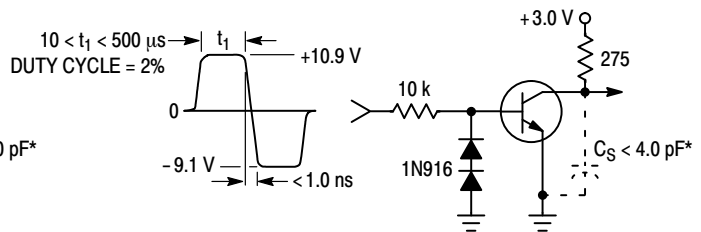

Figure 3. Turn-Off Time

*Total shunt capacitance of test jig and connectors

MMBT6521LT1G, SMMBT6521LT1G

TYPICAL NOISE CHARACTERISTICS

($V_{CE} = 5.0 \text{ Vdc}$, $T_A = 25^\circ\text{C}$)

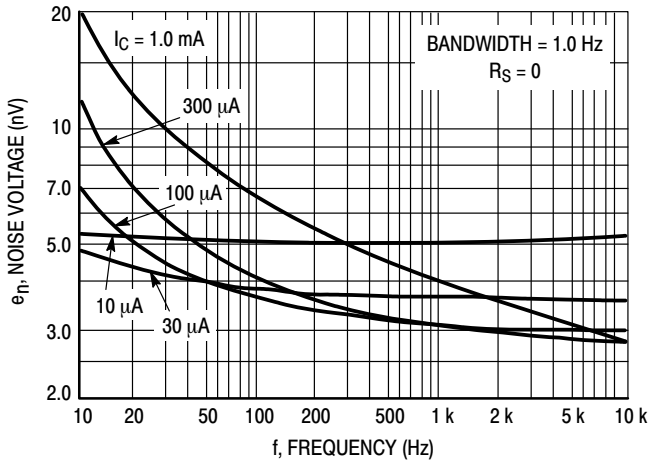

Figure 4. Noise Voltage

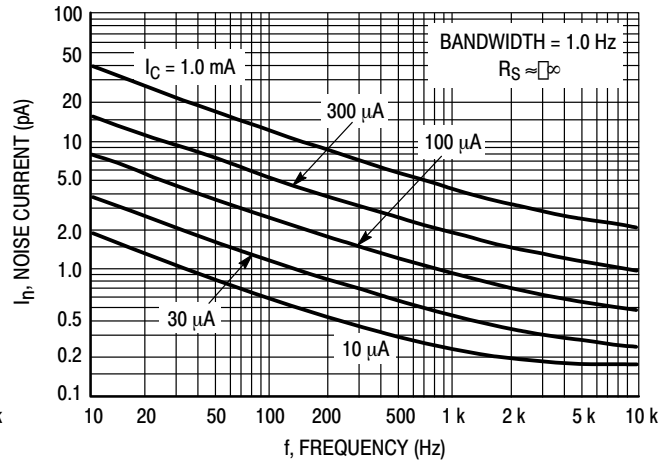

Figure 5. Noise Current

NOISE FIGURE CONTOURS

($V_{CE} = 5.0 \text{ Vdc}$, $T_A = 25^\circ\text{C}$)

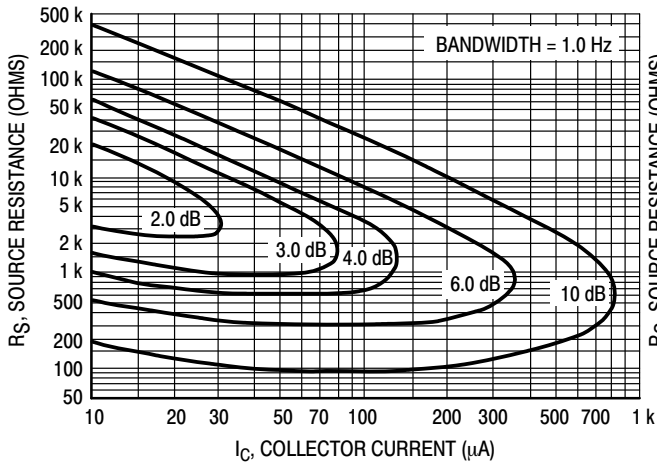

Figure 6. Narrow Band, 100 Hz

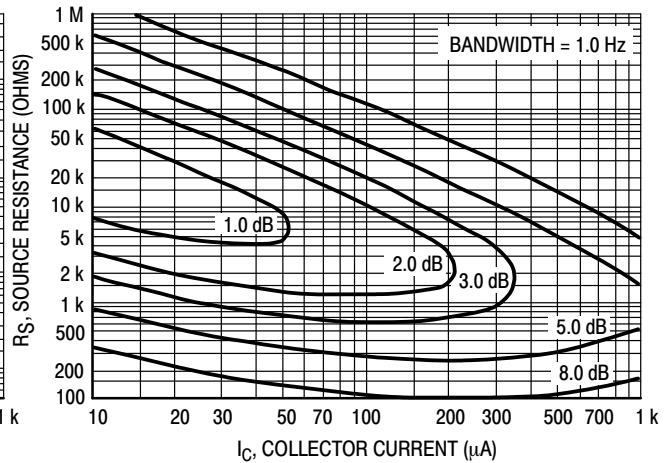

Figure 7. Narrow Band, 1.0 kHz

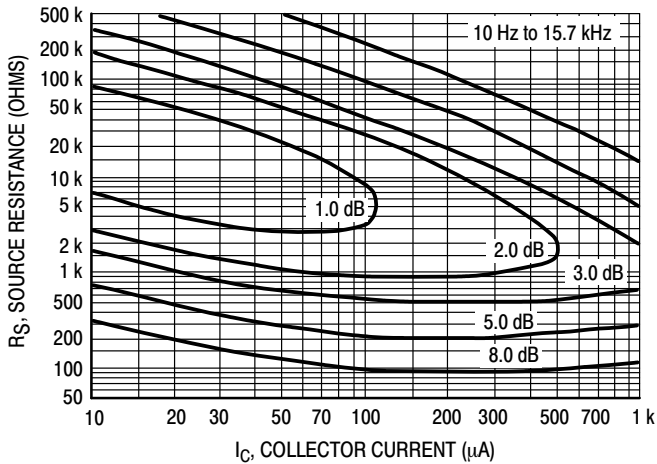

Figure 8. Wideband

Noise Figure is defined as:

$$NF = 20 \log_{10} \left(\frac{e_n^2 + 4KTR_S + I_n^2 R_S^2}{4KTR_S} \right)^{1/2}$$

e_n = Noise Voltage of the Transistor referred to the input. (Figure 3)

I_n = Noise Current of the Transistor referred to the input. (Figure 4)

K = Boltzman's Constant ($1.38 \times 10^{-23} \text{ J}^\circ\text{K}$)

T = Temperature of the Source Resistance ($^\circ\text{K}$)

R_S = Source Resistance (Ohms)

MMBT6521LT1G, SMMBT6521LT1G

TYPICAL STATIC CHARACTERISTICS

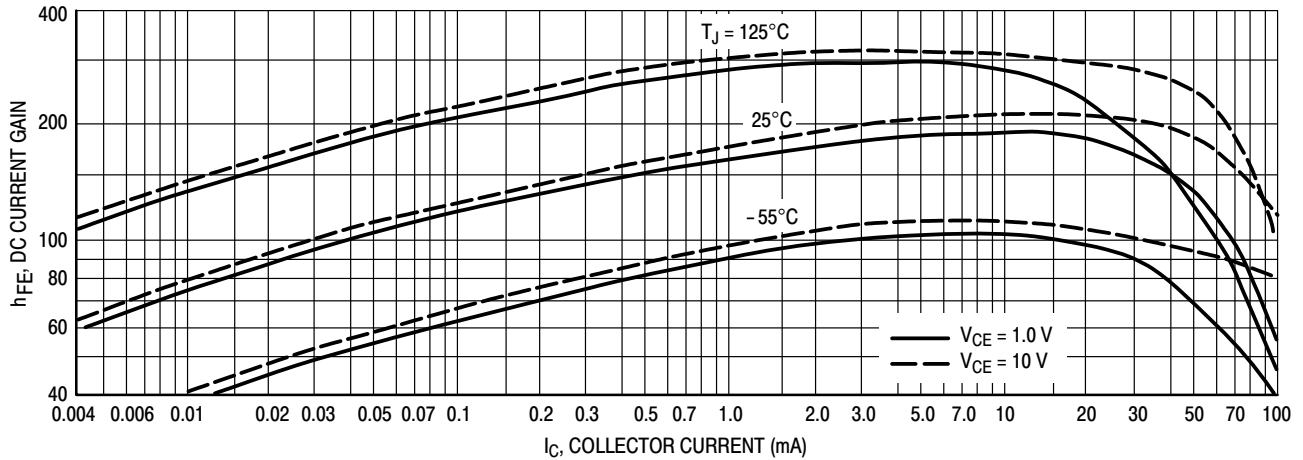

Figure 9. DC Current Gain

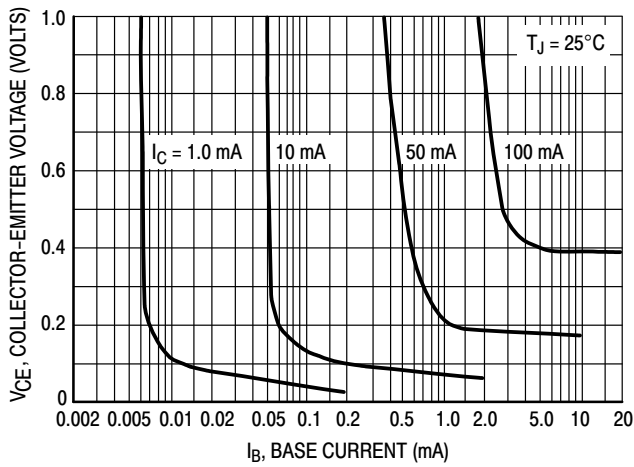

Figure 10. Collector Saturation Region

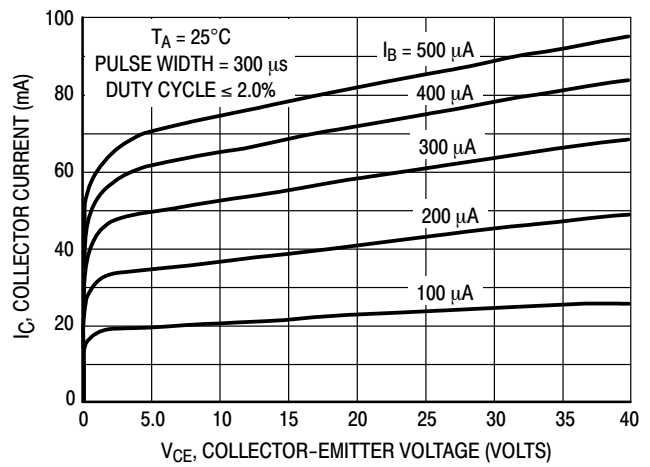

Figure 11. Collector Characteristics

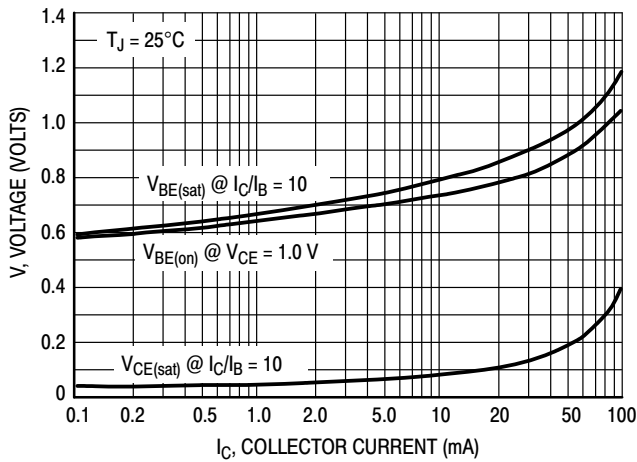

Figure 12. "On" Voltages

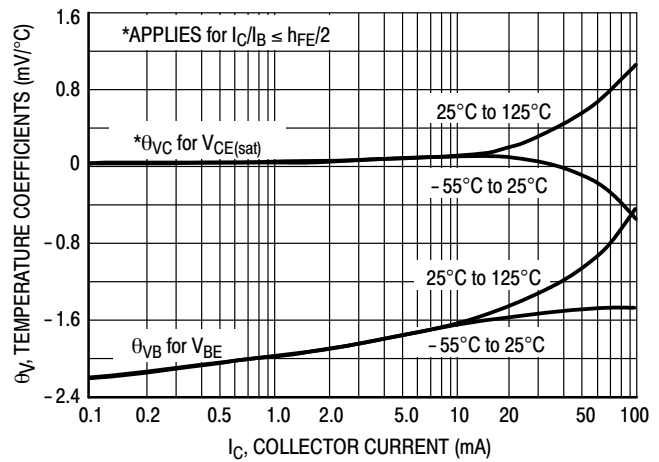

Figure 13. Temperature Coefficients

MMBT6521LT1G, SMMBT6521LT1G

TYPICAL DYNAMIC CHARACTERISTICS

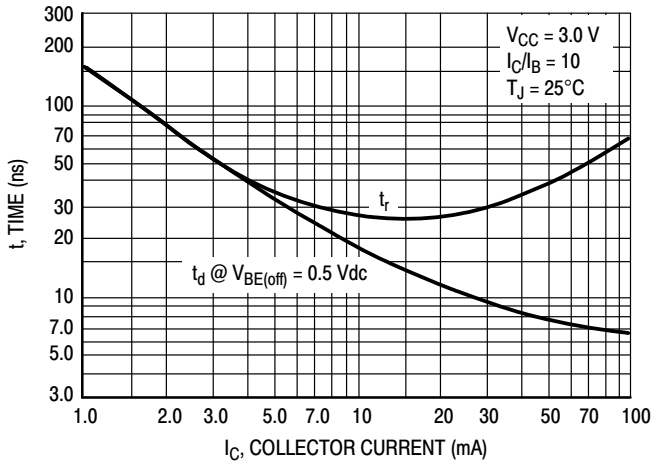

Figure 14. Turn-On Time

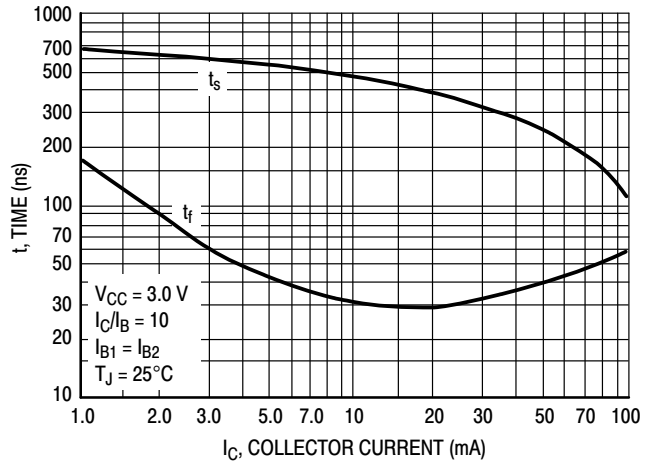

Figure 15. Turn-Off Time

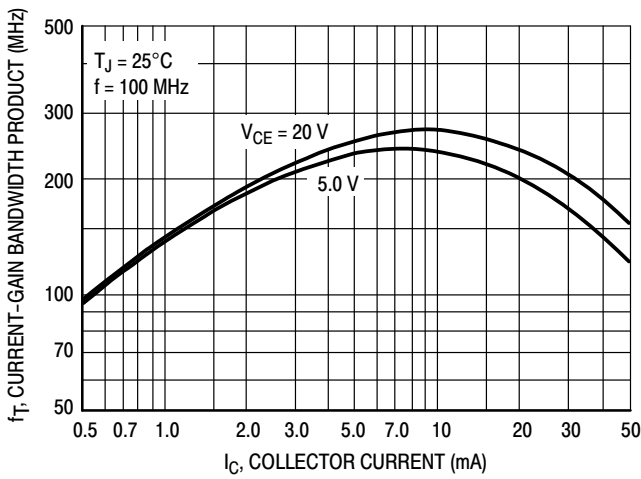

Figure 16. Current-Gain — Bandwidth Product

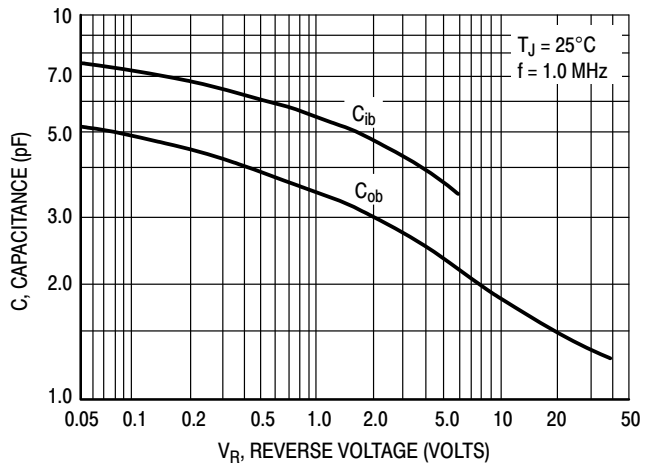

Figure 17. Capacitance

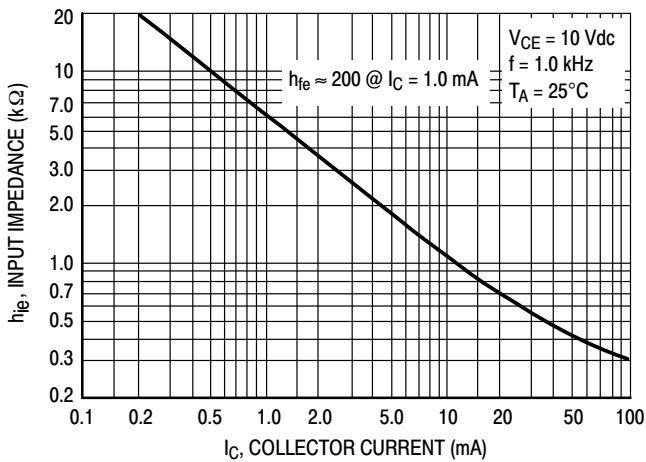

Figure 18. Input Impedance

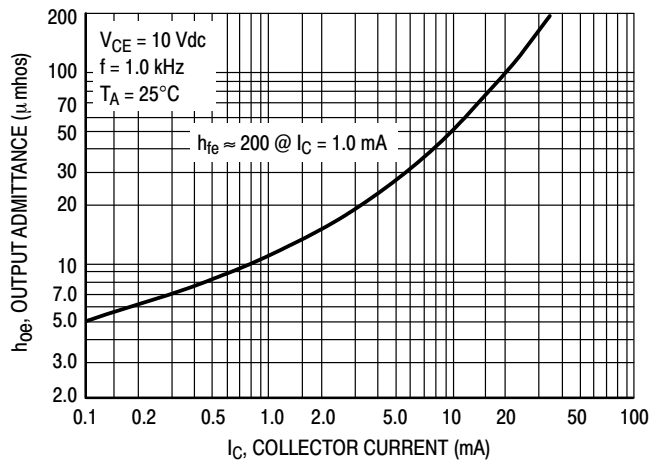

Figure 19. Output Admittance

MMBT6521LT1G, SMMBT6521LT1G

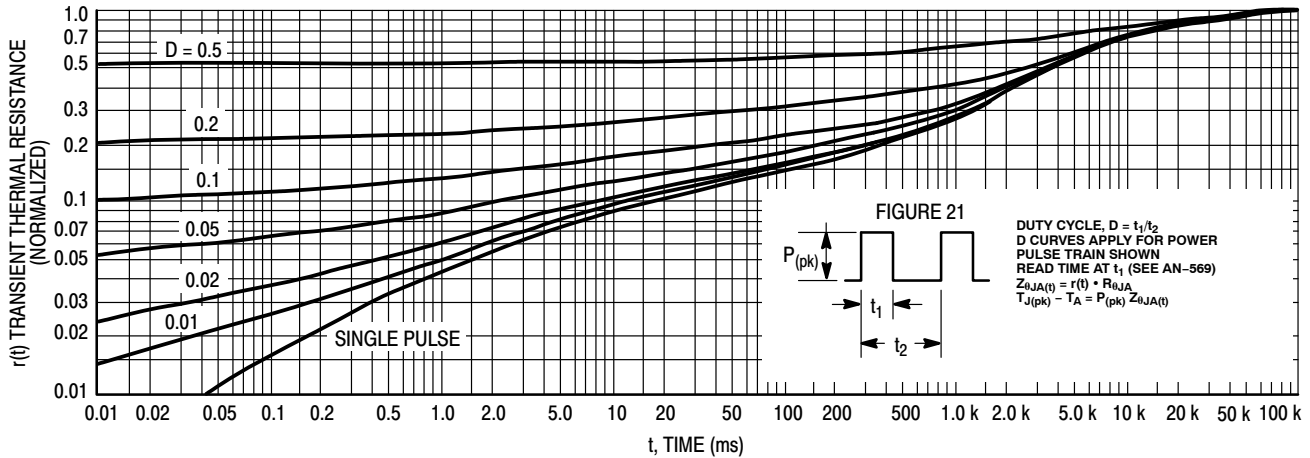

Figure 20. Thermal Response

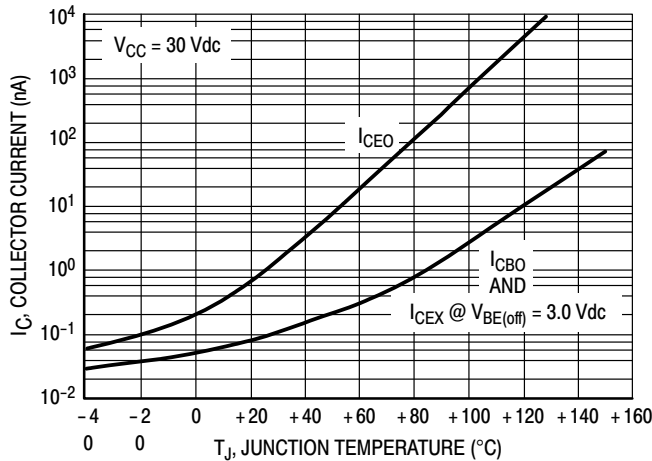

Figure 21.

DESIGN NOTE: USE OF THERMAL RESPONSE DATA

A train of periodical power pulses can be represented by the model as shown in Figure 21. Using the model and the device thermal response the normalized effective transient thermal resistance of Figure 20 was calculated for various duty cycles.

To find $Z_{\theta JA}(t)$, multiply the value obtained from Figure 20 by the steady state value $R_{\theta JA}$.

Example:

The MPS6521 is dissipating 2.0 watts peak under the following conditions:

$$t_1 = 1.0 \text{ ms}, t_2 = 5.0 \text{ ms. (D = 0.2)}$$

Using Figure 20 at a pulse width of 1.0 ms and D = 0.2, the reading of $r(t)$ is 0.22.

The peak rise in junction temperature is therefore

$$\Delta T = r(t) \times P_{(pk)} \times R_{\theta JA} = 0.22 \times 2.0 \times 200 = 88^\circ\text{C}.$$

For more information, see ON Semiconductor Application Note AN569/D, available from the Literature Distribution Center or on our website at www.onsemi.com.

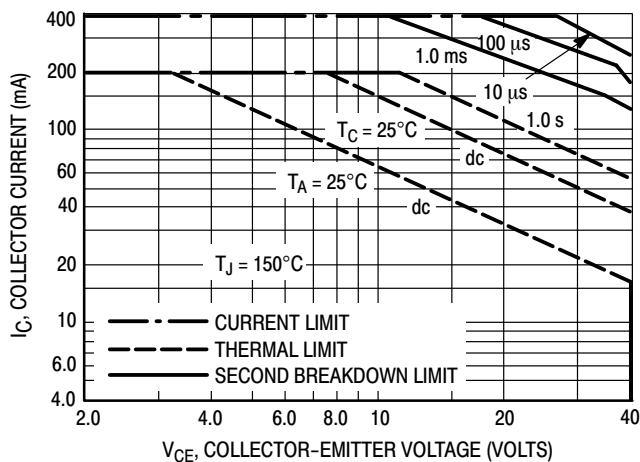

Figure 22.

The safe operating area curves indicate I_C - V_{CE} limits of the transistor that must be observed for reliable operation. Collector load lines for specific circuits must fall below the limits indicated by the applicable curve.

The data of Figure 22 is based upon $T_{J(pk)} = 150^\circ\text{C}$; T_C or T_A is variable depending upon conditions. Pulse curves are valid for duty cycles to 10% provided $T_{J(pk)} \leq 150^\circ\text{C}$. $T_{J(pk)}$ may be calculated from the data in Figure 20. At high case or ambient temperatures, thermal limitations will reduce the power that can be handled to values less than the limitations imposed by second breakdown.

MMBT6521LT1G, SMMBT6521LT1G

PACKAGE DIMENSIONS

SOT-23 (TO-236)
CASE 318-08
ISSUE AP

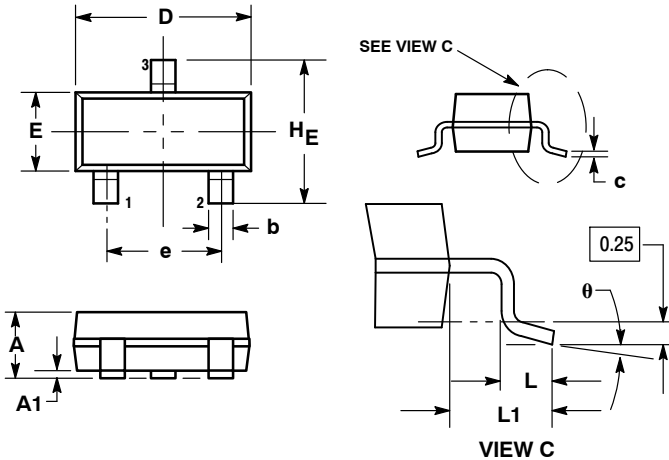

NOTES:

1. DIMENSIONING AND TOLERANCING PER ANSI Y14.5M, 1982.
2. CONTROLLING DIMENSION: INCH.
3. MAXIMUM LEAD THICKNESS INCLUDES LEAD FINISH THICKNESS. MINIMUM LEAD THICKNESS IS THE MINIMUM THICKNESS OF BASE MATERIAL.
4. DIMENSIONS D AND E DO NOT INCLUDE MOLD FLASH, PROTRUSIONS, OR GATE BURRS.

DIM	MILLIMETERS			INCHES		
	MIN	NOM	MAX	MIN	NOM	MAX
A	0.89	1.00	1.11	0.035	0.040	0.044
A1	0.01	0.06	0.10	0.001	0.002	0.004
b	0.37	0.44	0.50	0.015	0.018	0.020
c	0.09	0.13	0.18	0.003	0.005	0.007
D	2.80	2.90	3.04	0.110	0.114	0.120
E	1.20	1.30	1.40	0.047	0.051	0.055
e	1.78	1.90	2.04	0.070	0.075	0.081
L	0.10	0.20	0.30	0.004	0.008	0.012
L1	0.35	0.54	0.69	0.014	0.021	0.029
HE	2.10	2.40	2.64	0.083	0.094	0.104
θ	0°	---	10°	0°	---	10°

STYLE 6:

- PIN 1. BASE
- EMITTER
- COLLECTOR

SOLDERING FOOTPRINT

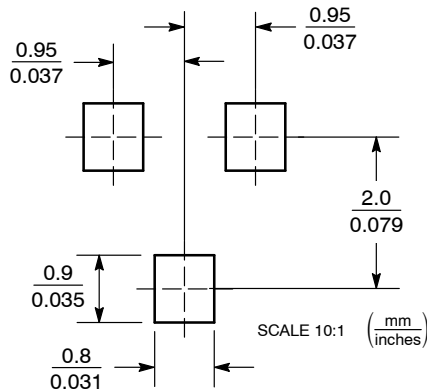

ON Semiconductor and are registered trademarks of Semiconductor Components Industries, LLC (SCILLC). SCILLC reserves the right to make changes without further notice to any products herein. SCILLC makes no warranty, representation or guarantee regarding the suitability of its products for any particular purpose, nor does SCILLC assume any liability arising out of the application or use of any product or circuit, and specifically disclaims any and all liability, including without limitation special, consequential or incidental damages. "Typical" parameters which may be provided in SCILLC data sheets and/or specifications can and do vary in different applications and actual performance may vary over time. All operating parameters, including "Typicals" must be validated for each customer application by customer's technical experts. SCILLC does not convey any license under its patent rights nor the rights of others. SCILLC products are not designed, intended, or authorized for use as components in systems intended for surgical implant into the body, or other applications intended to support or sustain life, or for any other application in which the failure of the SCILLC product could create a situation where personal injury or death may occur. Should Buyer purchase or use SCILLC products for any such unintended or unauthorized application, Buyer shall indemnify and hold SCILLC and its officers, employees, subsidiaries, affiliates, and distributors harmless against all claims, costs, damages, and expenses, and reasonable attorney fees arising out of, directly or indirectly, any claim of personal injury or death associated with such unintended or unauthorized use, even if such claim alleges that SCILLC was negligent regarding the design or manufacture of the part. SCILLC is an Equal Opportunity/Affirmative Action Employer. This literature is subject to all applicable copyright laws and is not for resale in any manner.

PUBLICATION ORDERING INFORMATION

LITERATURE FULFILLMENT:
Literature Distribution Center for ON Semiconductor
P.O. Box 5163, Denver, Colorado 80217 USA
Phone: 303-675-2175 or 800-344-3860 Toll Free USA/Canada
Fax: 303-675-2176 or 800-344-3867 Toll Free USA/Canada
Email: orderlit@onsemi.com

N. American Technical Support: 800-282-9855 Toll Free
USA/Canada
Europe, Middle East and Africa Technical Support:
Phone: 421 33 790 2910
Japan Customer Focus Center
Phone: 81-3-5817-1050

ON Semiconductor Website: www.onsemi.com
Order Literature: <http://www.onsemi.com/orderlit>

For additional information, please contact your local Sales Representative