

SPECIFICATIONS

Material: E-SEELS — Silicone rubber polymer type ASTM D 1418
Mounting Nut: E-SEELS: ALUMINUM INSERT
Temperature Range: E-SEELS: -80°F to +400°F
Pressure Range: Exceeds 15 psi internal and 1500 psi external.
 (N5032B: 10 psi)
Operational Life: 50,000 actuations (minimum).
Shelf Life: Excess of 25 years.
Resistant to: Salt spray, sunlight, ozone, weather, fungus, and most acids and lubricating oils
Agency Recognition: E-SEELS and HEXSEALS are UL-listed to UL Std. 50 types 1-13, and meet CSA standards.
Installation: If a reducing adaptor is required – see page 14 of HEXSEAL catalog HEX200 for part numbers and drawing.

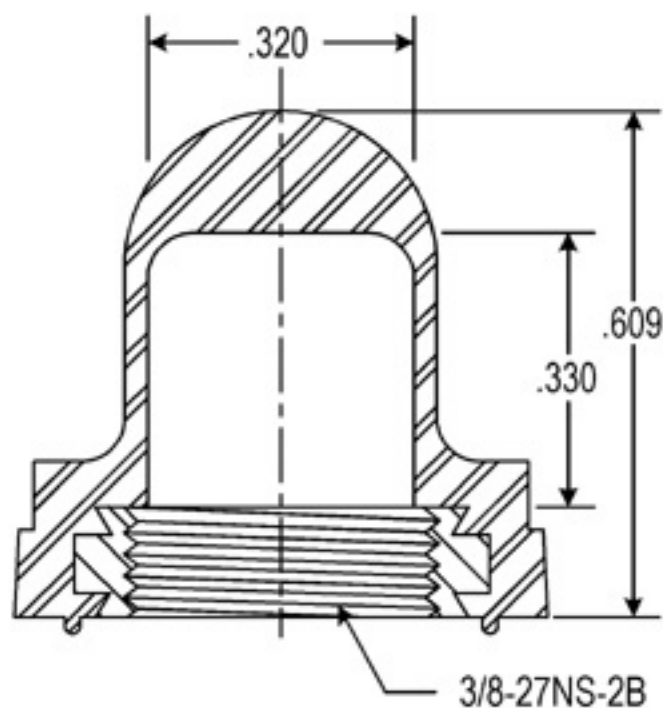
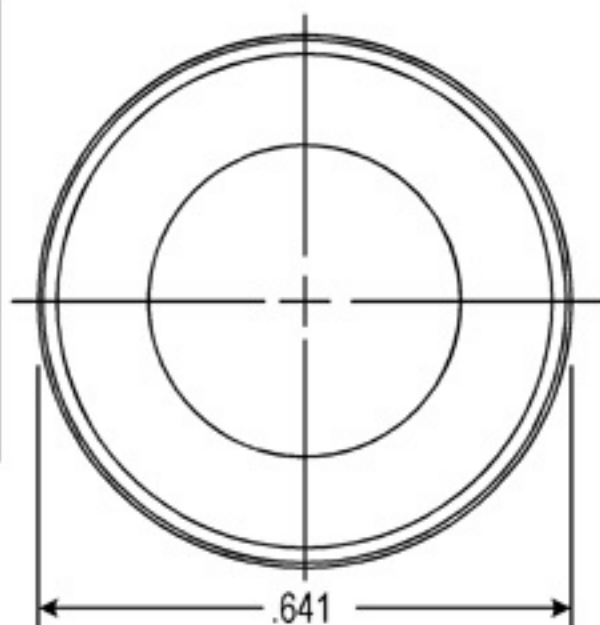

A		CAD COMPUTER GENERATED		9/23/02	
REV.	DESCRIPTION			DATE	
MAXIMUM AND MINIMUM MEASUREMENTS ARE STATED DIRECTLY ON EACH DIMENSION.		TITLE: BOOT-PLUNGER (C1221/21)		ENG. DWN. CARBONE	5-13-69
MAT'L: SILICONE RUBBER ASTM D 1418		APM-HEXSEAL CORPORATION		CHKD. NICK	5-13-69
FINISH: CLEAR				SCALE 4:1	DWG. NO. (C1221/21) E-SEEL®

THIS DRAWING COVERS PROPRIETARY ITEM AND IS THE PROPERTY OF THE APM-HEXSEAL CORPORATION. THIS DRAWING IS NOT TO BE COPIED OR USED WITHOUT THE WRITTEN APPROVAL OF AN OFFICER OF THE APM-HEXSEAL CORPORATION.