

## FEATURES

- 17 $\mu$ A Max Supply Current per Amplifier
- 70 $\mu$ V Max Offset Voltage
- 250pA Max Offset Current
- 5nA Max Input Bias Current
- 0.9 $\mu$ V<sub>p-p</sub> 0.1Hz to 10Hz Voltage Noise
- 1.5pA<sub>p-p</sub> 0.1Hz to 10Hz Current Noise
- 0.5 $\mu$ V/ $^{\circ}$ C Offset Voltage Drift
- 85kHz Gain-Bandwidth Product
- 0.04V/ $\mu$ s Slew Rate
- Single Supply Operation:
  - Input Voltage Range Includes Ground
  - Output Swings to Ground While Sinking Current
  - No Pull Down Resistors are Needed
- Output Sources and Sinks 5mA Load Current

## APPLICATIONS

- Battery or Solar Powered Systems
  - Portable Instrumentation
  - Remote Sensor Amplifier
  - Satellite Circuitry
- Micropower Sample-and-Hold
- Thermocouple Amplifier
- Micropower Filters

 LTC and LT are registered trademarks of Linear Technology Corporation.

## DESCRIPTION

The LT<sup>®</sup>1178 is a micropower dual op amp in the standard 8-pin configuration; the LT1179 is a micropower quad op amp offered in the standard 14-pin packages. Both devices are optimized for single supply operation at 5V. Specifications are also provided at  $\pm$ 15V supplies.

The extremely low supply current is combined with true precision specifications: offset voltage is 30 $\mu$ V, offset current is 50pA. Both offset parameters have low drift with temperature. The 1.5pA<sub>p-p</sub> current noise and picoampere offset current permit the use of megaohm level source resistors without introducing serious errors. Voltage noise, at 0.9 $\mu$ V<sub>p-p</sub>, is remarkably low considering the low supply current.

Both the LT1178 and LT1179 can be operated from a single supply (as low as one lithium cell or two NiCd batteries). The input range goes below ground. The all-NPN output stage swings to within a few millivolts of ground while sinking current—no power consuming pull down resistors are needed.

For applications where three times higher supply current is acceptable, the micropower LT1077 single, LT1078 dual and LT1079 quad are recommended. The LT1077/78/79 have significantly higher bandwidth, slew rate, lower voltage noise and better output drive capability.

## TYPICAL APPLICATION

Self-Buffered, Dual Output, Micropower Reference

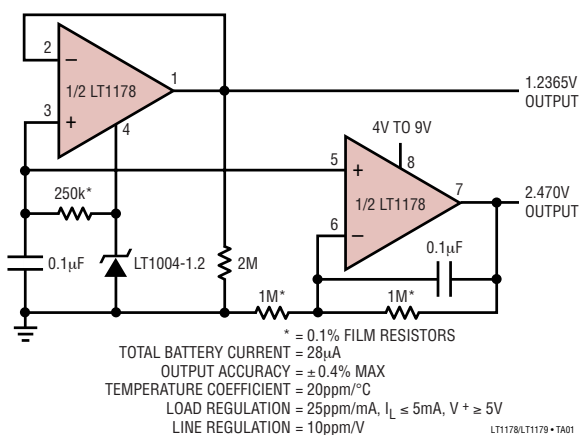

Supply Current vs Temperature

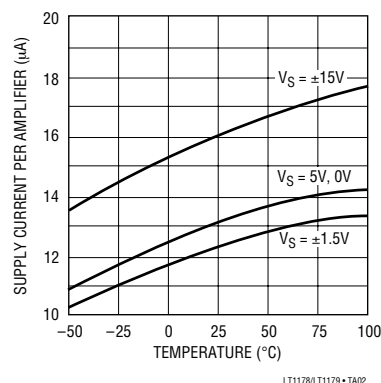

# LT1178/LT1179

## ABSOLUTE MAXIMUM RATINGS (Note 1)

Supply Voltage .....	$\pm 22V$	Operating Temperature Range	
Differential Input Voltage .....	$\pm 30V$	LT1178I/LT1179I .....	$-40^{\circ}C$ to $85^{\circ}C$
Input Voltage .....	Equal to Positive Supply Voltage	LT1178C/LT1178S/LT1179C/LT1179S .....	$0^{\circ}C$ to $70^{\circ}C$
Input Voltage .....	5V Below Negative Supply Voltage	Storage Temperature Range .....	$-65^{\circ}C$ to $150^{\circ}C$
Output Short-Circuit Duration .....	Indefinite	Lead Temperature (Soldering, 10 sec.) .....	$300^{\circ}C$

## PACKAGE/ORDER INFORMATION

<p>TOP VIEW</p> <p>OUT A 1, -IN A 2, IN A 3, V- 4, +IN B 5, -IN B 6, OUT B 7, V+ 8</p> <p>N PACKAGE 8-LEAD PDIP T<sub>JMAX</sub> = 100°C, <math>\theta_{JA}</math> = 150°C/W</p> <p>H PACKAGE 8-LEAD TO-5 METAL CAN</p> <p>J PACKAGE 8-LEAD CERDIP</p>	<p>ORDER PART NUMBER</p> <p>LT1178ACH LT1178CH</p>	<p>TOP VIEW</p> <p>OUT A 1, -IN A 2, +IN A 3, V- 4, -IN B 5, +IN B 6, OUT B 7, V+ 8</p> <p>N PACKAGE 8-LEAD PDIP T<sub>JMAX</sub> = 100°C, <math>\theta_{JA}</math> = 150°C/W</p> <p>J PACKAGE 8-LEAD CERDIP</p>	<p>ORDER PART NUMBER</p> <p>LT1178ACN8 LT1178CN8 LT1178IN8</p>	<p>TOP VIEW</p> <p>+IN A 1, V- 2, +IN B 3, -IN B 4, OUT B 5, V+ 6, OUT A 7, -IN A 8</p> <p>S8 PACKAGE 8-LEAD PLASTIC SO T<sub>JMAX</sub> = 150°C, <math>\theta_{JA}</math> = 200°C/W</p>	<p>ORDER PART NUMBER</p> <p>LT1178S8</p> <p>PART MARKING</p> <p>1178</p>
<p><b>OBSELETE PACKAGE</b> Consider the N8 or S8 Package for Alternate Source</p>					
<p>TOP VIEW</p> <p>OUT A 1, -IN A 2, +IN A 3, V+ 4, +IN B 5, -IN B 6, OUT B 7, OUT C 8, -IN C 9, +IN C 10, V- 11, +IN D 12, -IN D 13, OUT D 14</p> <p>N PACKAGE 14-LEAD PDIP T<sub>JMAX</sub> = 110°C, <math>\theta_{JA}</math> = 130°C/W</p> <p>J PACKAGE 14-LEAD CERAMIC DIP</p>	<p>ORDER PART NUMBER</p> <p>LT1179ACN LT1179CN LT1179IN</p>	<p>Not Recommended. Use LT1178S8 for New Designs.</p> <p>TOP VIEW</p> <p>NC 1, NC 2, OUT A 3, -IN A 4, +IN A 5, V- 6, NC 7, NC 8, NC 9, NC 10, +IN B 11, -IN B 12, OUT B 13, V+ 14, NC 15, NC 16</p> <p>SW PACKAGE 16-LEAD PLASTIC SO WIDE T<sub>JMAX</sub> = 150°C, <math>\theta_{JA}</math> = 90°C/W</p>	<p>ORDER PART NUMBER</p> <p>LT1178SW LT1179SW</p>	<p>TOP VIEW</p> <p>OUT A 1, -IN A 2, +IN A 3, V+ 4, +IN B 5, -IN B 6, OUT B 7, NC 8, NC 9, OUT C 10, -IN C 11, +IN C 12, V- 13, +IN D 14, -IN D 15, OUT D 16</p> <p>SW PACKAGE 16-LEAD PLASTIC SO WIDE T<sub>JMAX</sub> = 150°C, <math>\theta_{JA}</math> = 90°C/W</p>	
<p><b>OBSELETE PACKAGE</b> Consider the N14 Package for Alternate Source</p>		<p><b>OBSELETE PACKAGE</b> Consider the N14 Package for Alternate Source</p>		<p>LT1178/1179 • P0101</p>	

Consult LTC Marketing for parts specified with wider operating temperature ranges. Please note that the LT1178S8 surface mount pinout differs from that of the LT1178 standard plastic or ceramic dual-in-line packages. For similar performance with standard pinout, see the LT2178.

## ELECTRICAL CHARACTERISTICS $V_S = 5V, 0V; V_{CM} = 0.1V, V_O = 1.4V, T_A = 25^{\circ}C$ , unless noted.

SYMBOL	PARAMETER	CONDITIONS (NOTE 2)	LT1178AC/LT1179AC			LT1178I/C/S/LT1179I/C/S			UNITS
			MIN	TYP	MAX	MIN	TYP	MAX	
$V_{OS}$	Input Offset Voltage	LT1178		30	70	40	120	$\mu V$	
		LT1179		35	100	40	150	$\mu V$	
		LT1178SW				80	450	$\mu V$	
		LT1179SW				90	600	$\mu V$	
		LT1178S8				60	180	$\mu V$	
$\frac{\Delta V_{OS}}{\Delta Time}$	Long Term Input Offset Voltage Stability			0.5		0.6		$\mu V/Mo$	
$I_{OS}$	Input Offset Current			0.05	0.25	0.05	0.35	nA	

**ELECTRICAL CHARACTERISTICS**  $V_S = 5V, 0V; V_{CM} = 0.1V, V_O = 1.4V, T_A = 25^\circ C$ , unless noted.

SYMBOL	PARAMETER	CONDITIONS (NOTE 2)	LT1178AC/LT1179AC			LT1178I/C/S/LT1179I/C/S			UNITS
			MIN	TYP	MAX	MIN	TYP	MAX	
$I_B$	Input Bias Current			3	5		3	6	nA
$e_n$	Input Noise Voltage	0.1Hz to 10Hz (Note 3)		0.9	2.0		0.9		$\mu V_{p-p}$
	Input Noise Voltage Density	$f_0 = 10\text{Hz}$ (Note 3) $f_0 = 1000\text{Hz}$ (Note 3)		50 49	75 65		50 49		$nV/\sqrt{Hz}$ $nV/\sqrt{Hz}$
$i_n$	Input Noise Current	0.1Hz to 10Hz (Note 3)		1.5	2.5		1.5		$pA_{p-p}$
	Input Noise Current Density	$f_0 = 10\text{Hz}$ (Note 3) $f_0 = 1000\text{Hz}$		0.03 0.01	0.07		0.03 0.01		$pA/\sqrt{Hz}$ $pA/\sqrt{Hz}$
	Input Resistance Differential Mode Common Mode	(Note 4)	0.8	2.0 12		0.6	2.0 12		$G\Omega$ $G\Omega$
	Input Voltage Range		3.5 0	3.9 -0.3		3.5 0	3.9 -0.3		V V
CMRR	Common Mode Rejection Ratio	$V_{CM} = 0V$ to 3.5V	93	103		90	102		dB
PSRR	Power Supply Rejection Ratio	$V_S = 2.2V$ to 12V	94	104		92	104		dB
$A_{VOL}$	Large Signal Voltage Gain	$V_O = 0.03V$ to 4V, No Load (Note 4) $V_O = 0.03V$ to 3.5V, $R_L = 50k$	140 80	700		110 70	700		V/mV V/mV
	Maximum Output Voltage Swing	Output Low, No Load Output Low, 2k to GND Output Low, $I_{SINK} = 100\mu A$ Output High, No Load Output High 2k to GND		6.5 0.2 120 4.2 3.5	9 0.6 160		6.5 0.2 120 4.4 3.8	9 0.6 160	mV mV mV V V
SR	Slew Rate	$A_V = 1, C_L = 10pF$ (Note 4)	0.013	0.025		0.013	0.025		V/ $\mu s$
GBW	Gain Bandwidth Product	$f_0 \leq 5kHz$		60			60		kHz
$I_S$	Supply Current per Amplifier	$V_S = \pm 1.5V, V_O = 0V$		13 12	18 17		14 13	21 20	$\mu A$ $\mu A$
	Channel Separation	$\Delta V_{IN} = 3V, R_L = 10k$		130			130		dB
	Minimum Supply Voltage	(Note 5)		2.0	2.2		2.0	2.2	V

**ELECTRICAL CHARACTERISTICS** The ● denotes specifications which apply over the full operating temperature range of  $-40^{\circ}\text{C} \leq T_A \leq 85^{\circ}\text{C}$  for I grades,  $0^{\circ}\text{C} \leq T_A \leq 70^{\circ}\text{C}$  for SW grades,  $V_S = 5\text{V}, 0\text{V}; V_{\text{CM}} = 0.1\text{V}, V_O = 1.4\text{V}$ , unless noted. (Note 7)

SYMBOL	PARAMETER	CONDITIONS		LT1178I/LT1179I			LT1178SW/LT1179SW			UNITS		
				MIN	TYP	MAX	MIN	TYP	MAX			
$V_{\text{OS}}$	Input Offset Voltage	LT1178 LT1179	●		80	315		120	650	$\mu\text{V}$		
			●		80	345		130	800	$\mu\text{V}$		
$\Delta V_{\text{OS}}/\Delta T$	Input Offset Voltage Drift	(Note 6)	●		0.6	3.0		0.8	4.5	$\mu\text{V}/^{\circ}\text{C}$		
$I_{\text{OS}}$	Input Offset Current		●		0.07	0.7		0.06	0.50	nA		
$I_{\text{B}}$	Input Bias Current		●		4	8		3	7	nA		
CMRR	Common Mode Rejection Ratio	$V_{\text{CM}} = 0.05\text{V}$ to $3.2\text{V}$ I grade $V_{\text{CM}} = 0\text{V}$ to $3.4\text{V}$ S grade	●		84	98		86	100	dB		
PSRR	Power Supply Rejection Ratio	$V_S = 3.0\text{V}$ to $12\text{V}$ I grade $V_S = 2.5\text{V}$ to $12\text{V}$ S grade	●		86	100		88	102	dB		
$A_{\text{VOL}}$	Large-Signal Voltage Gain	$V_O = 0.05\text{V}$ to $4\text{V}$ , No Load (Note 4) $V_O = 0.05\text{V}$ to $3.5\text{V}$ , $R_L = 50\text{k}$	●		55	350		80	500	V/mV		
			●		35	130		45	160	V/mV		
	Maximum Output Voltage Swing	Output Low, No Load Output Low, $I_{\text{SINK}} = 100\mu\text{A}$ Output High, No Load Output High, $2\text{k}$ to GND	●			9	13		8	11	mV	
			●				160	220		140	190	mV
			●		3.9	4.2		4.1	4.3			V
			●		3.0	3.7		3.3	3.8			V
$I_S$	Supply Current per Amplifier		●		15	27		15	24	$\mu\text{A}$		

The ● denotes specifications which apply over the full operating temperature range of  $0^{\circ}\text{C} \leq T_A \leq 70^{\circ}\text{C}$ ,  $V_S = 5\text{V}, 0\text{V}$ ,  $V_{\text{CM}} = 0.1\text{V}$ ,  $V_O = 1.4\text{V}$ , unless noted.

SYMBOL	PARAMETER	CONDITIONS		LT1178AC/LT1179AC			LT1178C/S8/LT1179C			UNITS		
				MIN	TYP	MAX	MIN	TYP	MAX			
$V_{\text{OS}}$	Input Offset Voltage	LT1178 LT1178S8 LT1179	●		50	170		65	250	$\mu\text{V}$		
			●					85	350	$\mu\text{V}$		
			●		60	200		70	290	$\mu\text{V}$		
$\Delta V_{\text{OS}}/\Delta T$	Input Offset Voltage Drift	(Note 6) LT1178S8	●		0.5	2.2		0.6	3.0	$\mu\text{V}/^{\circ}\text{C}$		
			●					0.6	3.5	$\mu\text{V}/^{\circ}\text{C}$		
$I_{\text{OS}}$	Input Offset Current		●		0.06	0.35		0.06	0.50	nA		
$I_{\text{B}}$	Input Bias Current		●		3	6		3	7	nA		
CMRR	Common Mode Rejection Ratio	$V_{\text{CM}} = 0\text{V}$ to $3.4\text{V}$	●		90	101		86	100	dB		
PSRR	Power Supply Rejection Ratio	$V_S = 2.5\text{V}$ to $12\text{V}$	●		90	102		88	102	dB		
$A_{\text{VOL}}$	Large-Signal Voltage Gain	$V_O = 0.05\text{V}$ to $4\text{V}$ , No Load (Note 4) $V_O = 0.05\text{V}$ to $3.5\text{V}$ , $R_L = 50\text{k}$	●		105	500		80	500	V/mV		
			●		55	160		45	160	V/mV		
	Maximum Output Voltage Swing	Output Low, No Load Output Low, $I_{\text{SINK}} = 100\mu\text{A}$ Output High, No Load Output High, $2\text{k}$ to GND	●			8	11		8	11	mV	
			●				140	190		140	190	mV
			●		4.1	4.3		4.1	4.3			V
			●		3.3	3.8		3.3	3.8			V
$I_S$	Supply Current per Amplifier		●		14	21		15	24	$\mu\text{A}$		

**ELECTRICAL CHARACTERISTICS**  $V_S = \pm 15V$ ,  $T_A = 25^\circ C$ , unless noted.

SYMBOL	PARAMETER	CONDITIONS	LT1178AC/LT1179AC			LT1178I/C/S/LT1179I/C/S			UNITS
			MIN	TYP	MAX	MIN	TYP	MAX	
$V_{OS}$	Input Offset Voltage	LT1178SW LT1179SW LT1178S8		80	350		100	480	$\mu V$
							150	900	$\mu V$
							160	1050	$\mu V$
							120	350	$\mu V$
$I_{OS}$	Input Offset Current		0.05	0.25		0.05	0.35	nA	
$I_B$	Input Bias Current		3	5		3	6	nA	
	Input Voltage Range		13.5 -15.0	13.9 -15.3		13.5 -15.0	13.9 -15.3	V V	
CMRR	Common Mode Rejection Ratio	$V_{CM} = 13.5V, -15V$	97	106		94	106	dB	
PSRR	Power Supply Rejection Ratio	$V_S = 5V, 0V$ to $\pm 18V$	96	112		94	112	dB	
$A_{VOL}$	Large-Signal Voltage Gain	$V_O = \pm 10V, R_L = 50k$ $V_O = \pm 10V, \text{No Load}$	300	1200		250	1000	V/mV	
			600	2500		400	2500	V/mV	
$V_{OUT}$	Maximum Output Voltage Swing	$R_L = 50k$ $R_L = 2k$	$\pm 13.0$	$\pm 14.2$		$\pm 13.0$	$\pm 14.2$	V	
			$\pm 11.0$	$\pm 12.7$		$\pm 11.0$	$\pm 12.7$	V	
SR	Slew Rate	$A_V = 1$	0.02	0.04		0.02	0.04	V/ $\mu s$	
GBW	Gain Bandwidth Product	$f_0 \leq 5kHz$		85			85	kHz	
$I_S$	Supply Current per Amplifier			16	21		17	25	$\mu A$

The ● denotes specifications which apply over the full operating temperature range of  $-40^\circ C \leq T_A \leq 85^\circ C$  for I grades,  $0^\circ C \leq T_A \leq 70^\circ C$  for SW grades,  $V_S = \pm 15V$ , unless noted.

SYMBOL	PARAMETER	CONDITIONS	LT1178I/LT1179I			LT1178SW/LT1179SW			UNITS
			MIN	TYP	MAX	MIN	TYP	MAX	
$V_{OS}$	Input Offset Voltage	LT1178	●	130	740		190	1150	$\mu V$
		LT1179	●	130	740		200	1300	$\mu V$
$\Delta V_{OS}/\Delta T$	Input Offset Voltage Drift	(Note 6)	●	0.7	4.0		0.9	5.5	$\mu V/^\circ C$
$I_{OS}$	Input Offset Current		●	0.07	0.7		0.06	0.35	nA
$I_B$	Input Bias Current		●	4	8		3	7	nA
$A_{VOL}$	Large-Signal Voltage Gain	$V_O = \pm 10V, R_L = 50k$	●	100	500		150	750	V/mV
CMRR	Common Mode Rejection Ratio	$V_{CM} = 13V, -14.9V$	●	88	103		91	104	dB
PSRR	Power Supply Rejection Ratio	$V_S = 5V, 0V$ to $\pm 18V$	●	88	109		91	110	dB
	Maximum Output Voltage Swing	$R_L = 5k$	●	$\pm 11.0$	$\pm 13.5$		$\pm 11.0$	$\pm 13.5$	V
$I_S$	Supply Current per Amplifier		●	19	30		18	28	$\mu A$

# LT1178/LT1179

## ELECTRICAL CHARACTERISTICS

The ● denotes specifications which apply over the full operating temperature range of  $0^{\circ}\text{C} \leq T_A \leq 70^{\circ}\text{C}$ ,  $V_S = \pm 15\text{V}$ , unless noted.

The ● denotes specifications which apply over the full operating temperature range of  $0^{\circ}\text{C} \leq T_A \leq 70^{\circ}\text{C}$ ,  $V_S = \pm 15\text{V}$ , unless noted.

SYMBOL	PARAMETER	CONDITIONS	LT1178AC/LT1179AC			LT1178C/S8/LT1179C			UNITS
			MIN	TYP	MAX	MIN	TYP	MAX	
$V_{OS}$	Input Offset Voltage	LT1178S8	●	100	480	130	660	$\mu\text{V}$	
$\Delta V_{OS}/\Delta T$	Input Offset Voltage Drift	(Note 6) LT1178S8	●	0.6	2.8	0.7	4.0	$\mu\text{V}/^{\circ}\text{C}$	
$I_{OS}$	Input Offset Current		●	0.06	0.35	0.06	0.35	nA	
$I_B$	Input Bias Current		●	3	6	3	7	nA	
$A_{VOL}$	Large-Signal Voltage Gain	$V_O = \pm 10\text{V}$ , $R_L = 50\text{k}$	●	200	800	150	750	V/mV	
CMRR	Common Mode Rejection Ratio	$V_{CM} = 13\text{V}$ , $-15\text{V}$	●	94	104	91	104	dB	
PSRR	Power Supply Rejection Ratio	$V_S = 5\text{V}$ , $0\text{V}$ to $\pm 18\text{V}$	●	93	110	91	110	dB	
	Maximum Output Voltage Swing	$R_L = 5\text{k}$	●	$\pm 11.0$	$\pm 13.6$	$\pm 11.0$	$\pm 13.6$	V	
$I_S$	Supply Current per Amplifier		●	17	24	18	28	$\mu\text{A}$	

**Note 1:** Absolute Maximum Ratings are those values beyond which the life of a device may be impaired.

**Note 2:** Typical parameters are defined as the 60% yield of parameter distributions of individual amplifiers; (i.e., out of 100 LT1179s, or 100 LT1178s, typically 240 op amps, or 120, will be better than the indicated specification).

**Note 3:** This parameter is tested on a sample basis only. All noise parameters are tested with  $V_S = \pm 2.5$ ,  $V_O = 0\text{V}$ .

**Note 4:** This parameter is guaranteed by design and is not tested.

**Note 5:** Power supply rejection ratio is measured at the minimum supply voltage. The op amps actually work at 1.7V supply but with a typical offset skew of  $-300\mu\text{V}$ .

**Note 6:** This parameter is not 100% tested.

**Note 7:** During testing at  $-40^{\circ}\text{C}$ , the 5V power supply turn on-time is less than 0.5 seconds.

## TYPICAL PERFORMANCE CHARACTERISTICS

Input Offset Voltage Distribution  
N, J, H Package



Input Offset Voltage Distribution  
Surface Mount Package



Minimum Supply Voltage

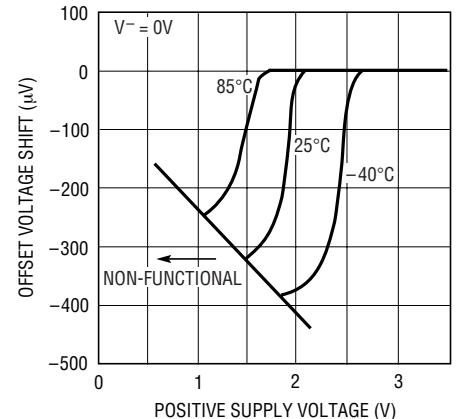

# TYPICAL PERFORMANCE CHARACTERISTICS

**Input Bias and Offset Currents vs Temperature**

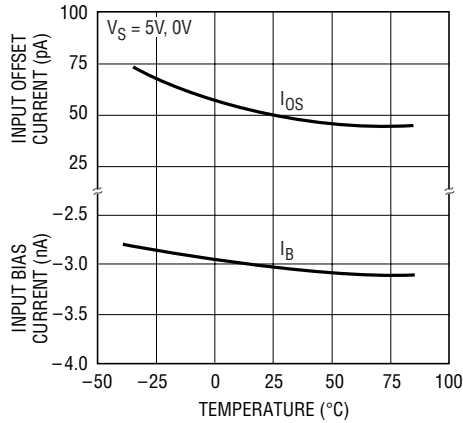

LT1178/LT1179 • TPC04

**Output Saturation vs Temperature vs Sink Current**



LT1178/LT1179 • TPC05

**Short-Circuit Current**

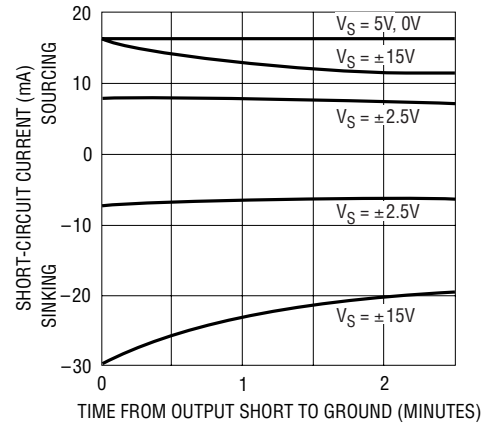

LT1178/LT1179 • TPC06

**0.1Hz to 10Hz Noise**

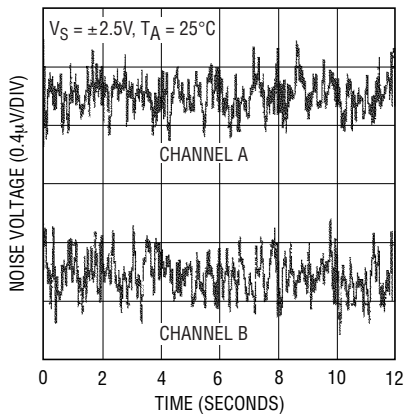

LT1178/LT1179 • TPC07

**0.01Hz to 10Hz Noise**



LT1178/LT1179 • TPC08

**Noise Spectrum**

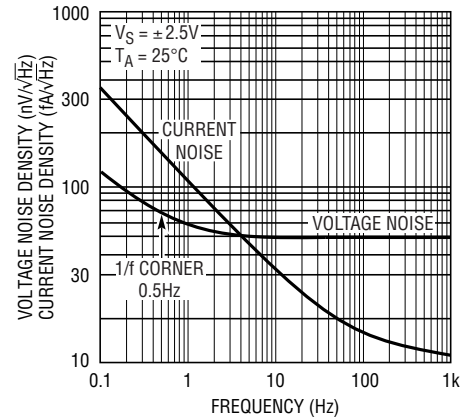

LT1178/LT1179 • TPC09

**Voltage Gain vs Frequency**



LT1178/LT1179 • TPC10

**Gain, Phase vs Frequency**

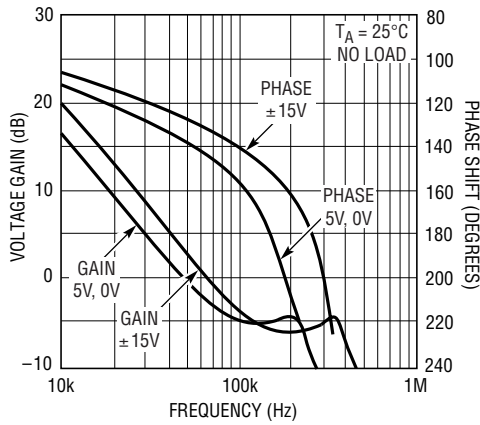

LT1178/LT1179 • TPC11

**Voltage Gain vs Load Resistance**

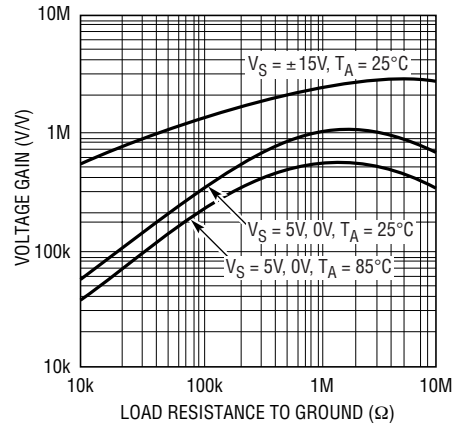

LT1178/LT1179 • TPC12

# TYPICAL PERFORMANCE CHARACTERISTICS

**Capacitive Load Handling**

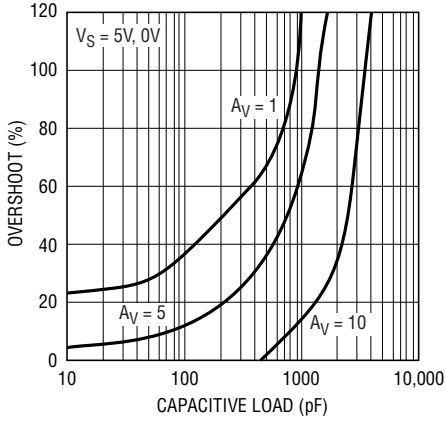

LT1178/LT1179 • TPC13

**Large-Signal Transient Response**  
 $V_S = \pm 15V$



$A_V = 1$   
 $C_L = 12pF$

**Large-Signal Transient Response**  
 $V_S = 5V, 0V$

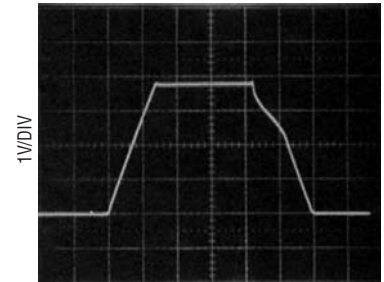

$A_V = 1$   
 $C_L = 12pF$   
INPUT PULSE = 0V TO 3.8V

**Small-Signal Transient Response**  
 $V_S = \pm 2.5V$



$A_V = 1$   
 $C_L = 12pF$

**Small-Signal Transient Response**  
 $V_S = \pm 15V$

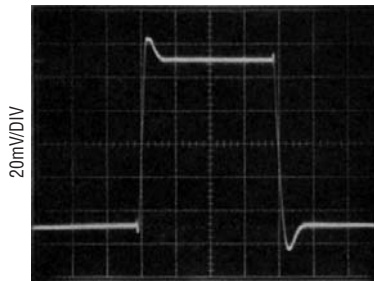

$A_V = 1$   
 $C_L = 12pF$

**Small-Signal Transient Response**  
 $V_S = 5V, 0V$

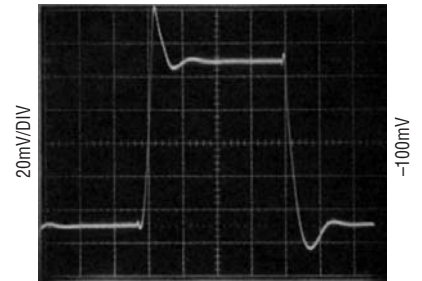

$A_V = 1$   
 $C_L = 12pF$   
INPUT 50 TO 150mV

**Common Mode Rejection Ratio vs Frequency**

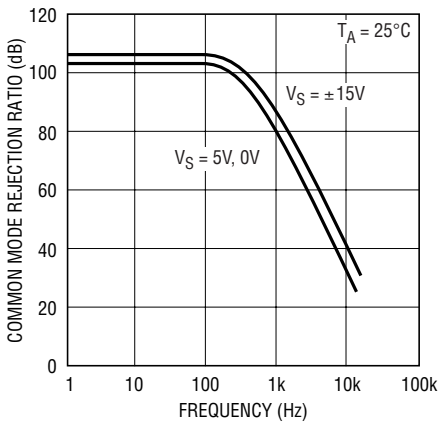

LT1178/LT1179 • TPC19

**Power Supply Rejection Ratio vs Frequency**

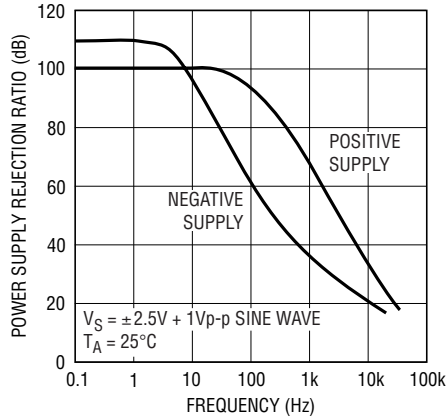

LT1188/LT1189 • TPC20

**Closed Loop Output Impedance**

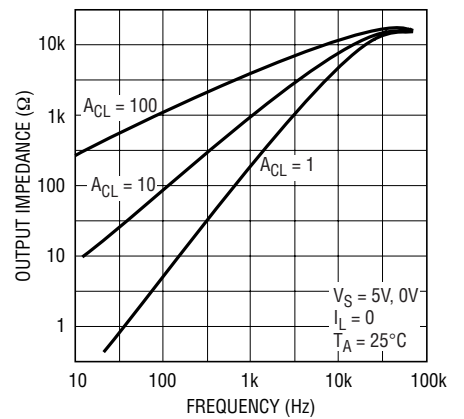

LT1178/LT1179 • TPC21



# APPLICATIONS INFORMATION

Please see the LT1078/LT1079 data sheet for applications information. All comments relating to specifications, single

supply operation and phase reversal protection are directly applicable to the LT1178/LT1179.

## Micropower 100Hz to 1MHz V-to-F Converter



# SIMPLIFIED SCHEMATIC

1/2 LT1178  
1/4 LT1179

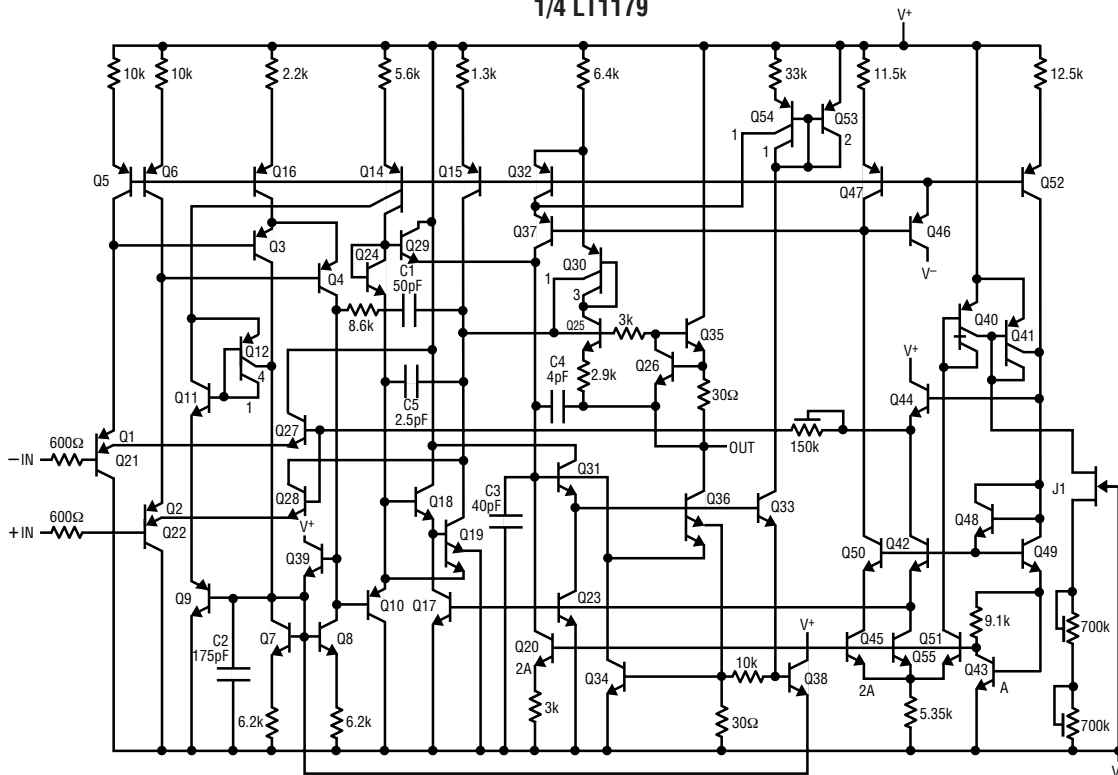

**PACKAGE DESCRIPTION**

**H Package**  
**8-Lead TO-5 Metal Can (.230 Inch PCD)**  
 (Reference LTC DWG # 05-08-1321)



**J8 Package**  
**8-Lead Cerdip (Narrow .300 Inch, Hermetic)**  
 (Reference LTC DWG # 05-08-1110)



**J Package**  
**14-Lead Cerdip (Narrow .300 Inch, Hermetic)**  
 (Reference LTC DWG # 05-08-1110)

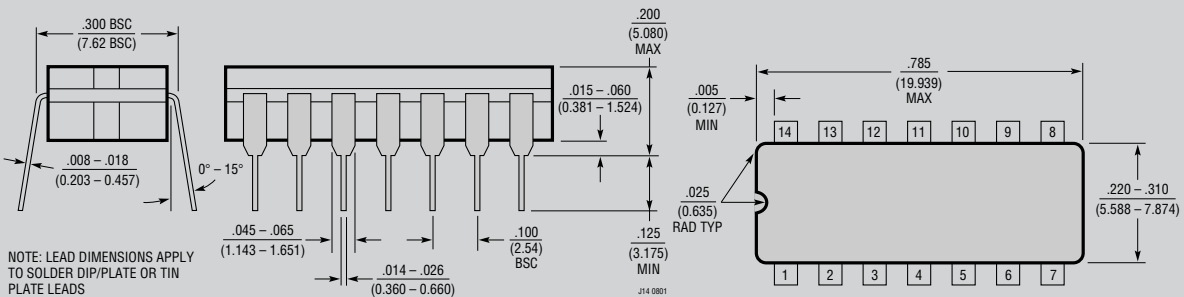

**OBSOLETE PACKAGES**

# PACKAGE DESCRIPTION

## N8 Package 8-Lead PDIP (Narrow .300 Inch) (Reference LTC DWG # 05-08-1510)



NOTE:  
1. DIMENSIONS ARE  $\frac{\text{INCHES}}{\text{MILLIMETERS}}$   
\*THESE DIMENSIONS DO NOT INCLUDE MOLD FLASH OR PROTRUSIONS.  
MOLD FLASH OR PROTRUSIONS SHALL NOT EXCEED .010 INCH (0.254mm)

## N Package 14-Lead PDIP (Narrow .300 Inch) (Reference LTC DWG # 05-08-1510)



NOTE:  
1. DIMENSIONS ARE  $\frac{\text{INCHES}}{\text{MILLIMETERS}}$   
\*THESE DIMENSIONS DO NOT INCLUDE MOLD FLASH OR PROTRUSIONS.  
MOLD FLASH OR PROTRUSIONS SHALL NOT EXCEED .010 INCH (0.254mm)

**PACKAGE DESCRIPTION**

**S8 Package**  
**8-Lead Plastic Small Outline (Narrow .150 Inch)**  
 (Reference LTC DWG # 05-08-1610)

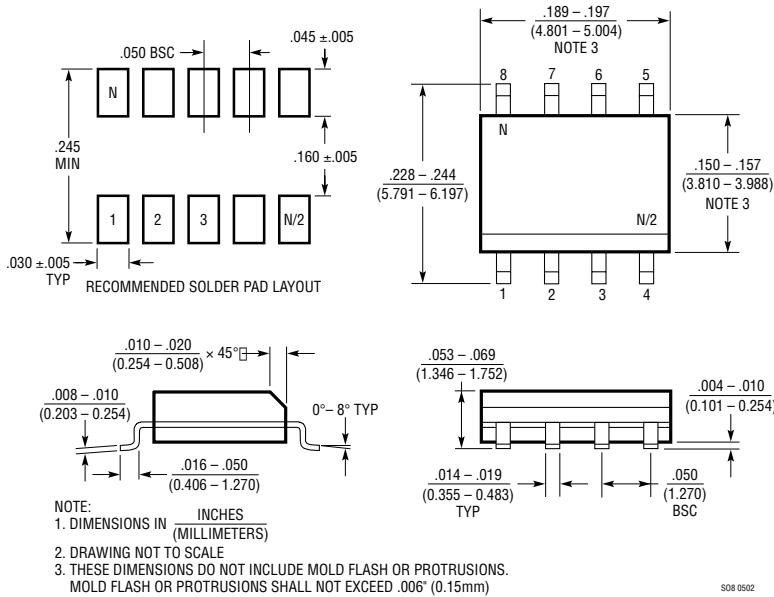

**SW Package**  
**16-Lead Plastic Small Outline (Wide .300 Inch)**  
 (Reference LTC DWG # 05-08-1620)

