

## SPECIFICATION

- Part No. : **AGGP.35F.07.0060A**
- Product Name : 35mm Two Stage 28dB GPS-GLONASS-GALILEO  
GNSS Active Patch  
Antenna Module with Front-end Saw Filter
- Features : Industry leading GPS/GLONASS/GALILEO antenna  
performance  
35\*35\*6.9mm (Ground Plane)  
60mm Ø1.13 IPEX MHFI (U.FL)  
28dB LNA  
Wide Input Voltage 1.8V to 5.5V  
Low Power Consumption  
**RoHS Compliant**

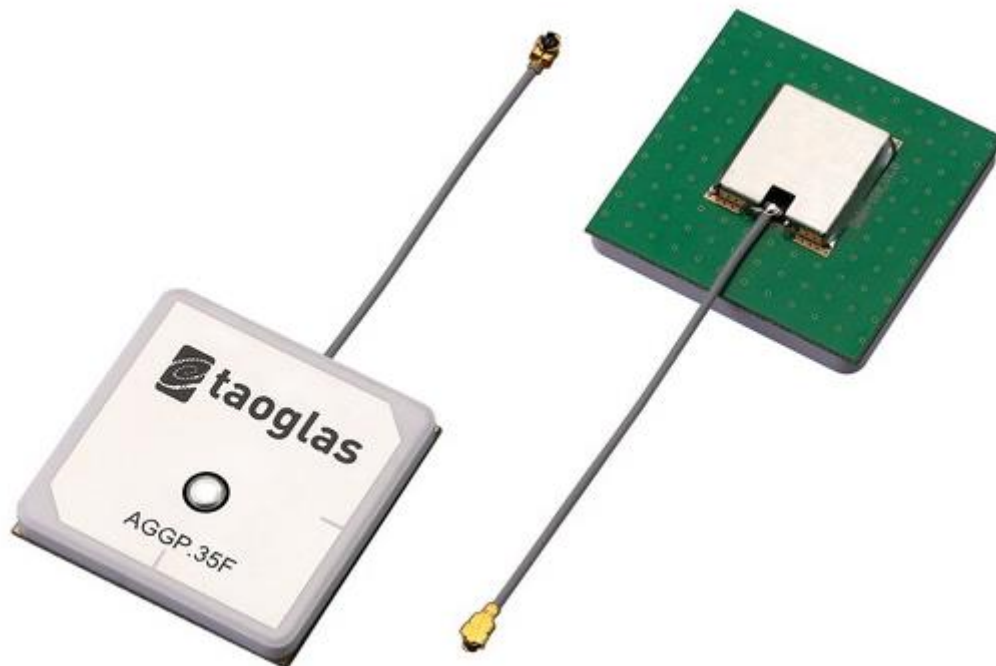

# 1. Introduction

The AGGP.35F GPS/GLONASS/GALILEO GNSS active patch antenna (along with the AGGP.25 model) is the best choice to use as an embedded antenna with the latest generation of GPS/GLONASS/GALILEO GNSS receivers. It utilizes a 35\*35\*3.5mm advanced wide-band ceramic patch antenna with optimized gain, radiation pattern and axial ratio at GPS, GALILEO and GLONASS centre frequencies.

The AGGP.35F also includes a two stage LNA and a front-end SAW filter to reduce out of band noise such as from nearby cellular transceiver, and improve probability of the wireless device passing radiated spurious emissions certification. Produced in TS16949 automotive quality approved facility and 100% tested for gain (S21), return loss (S11) to ensure total consistency of performance.

Cable type, length and connectors can be customized and samples offered according to requirement, subject to minimum order quantities in production. Taoglas also offers custom tuning service based on minimum order quantities, contact your local regional sales office for details.

The AGGP.35F consists of 2 functional blocks – the LNA and also the patch antenna.

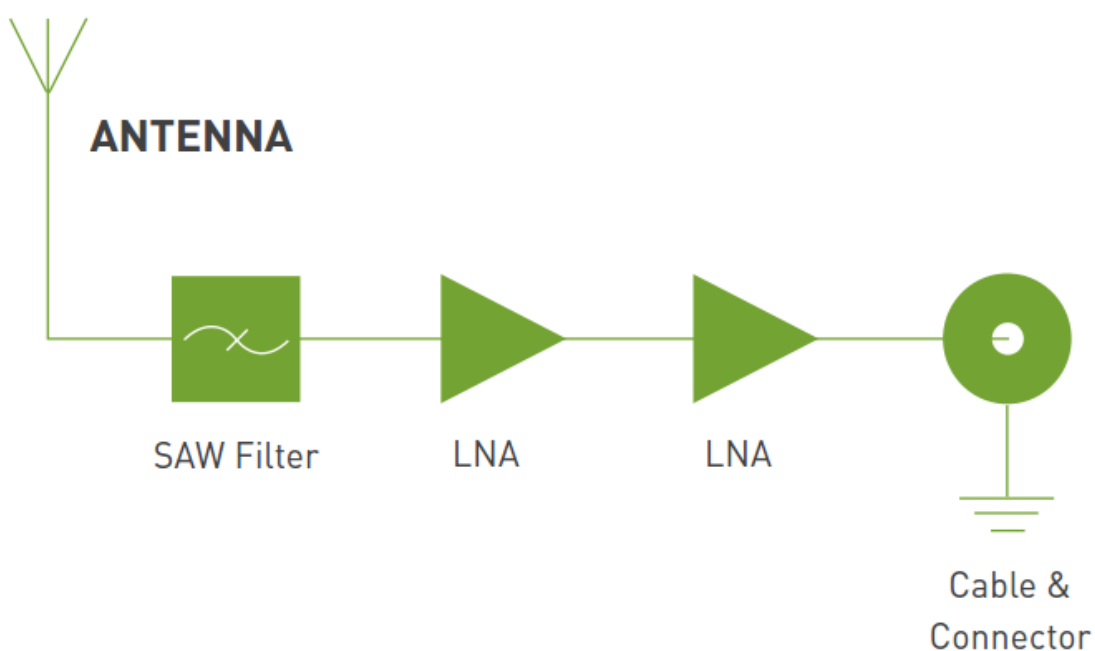

## 2. Specification

ELECTRICAL			
Operation Frequency	1574 ~ 1610MHz		
Patch Gain	1575.42MHz, 1dBic typ. @ zenith 1602MHz, 0.5dBic typ. @ zenith		
Overall Gain	1575.42MHz, 27 ± 3dBic typ. @ zenith 1602MHz, 28.5 ± 3dBic typ. @ zenith		
Axial Ratio	3.0dB max @ zenith.		
Polarization	Right Hand Circular		
VSWR	2.0 :1 max		
Impedance	50Ω		
DC input	1.8V min.	3.0V	5.5V max.
LNA Gain	22dB	28dB	31dB
Noise Figure	2.6dB	2.6dB	2.9dB
Power Consumption	5mA	10mA	23mA
Band Attenuation	15dB @ 1592 ± 140MHz		
MECHANICAL			
Antenna Dimensions	35 x 35 x 3.7mm		
Material	Ceramic		
Cable	60mm 1.13 co-axial		
Connector	IPEX MHF1		
ENVIRONMENTAL			
Operation Temperature	-40°C to 85°C		
Storage Temperature	-40°C to 105°C		
Relative Humidity	40% to 95%		

### 3. LNA Gain and Out Band Rejection @3.0V

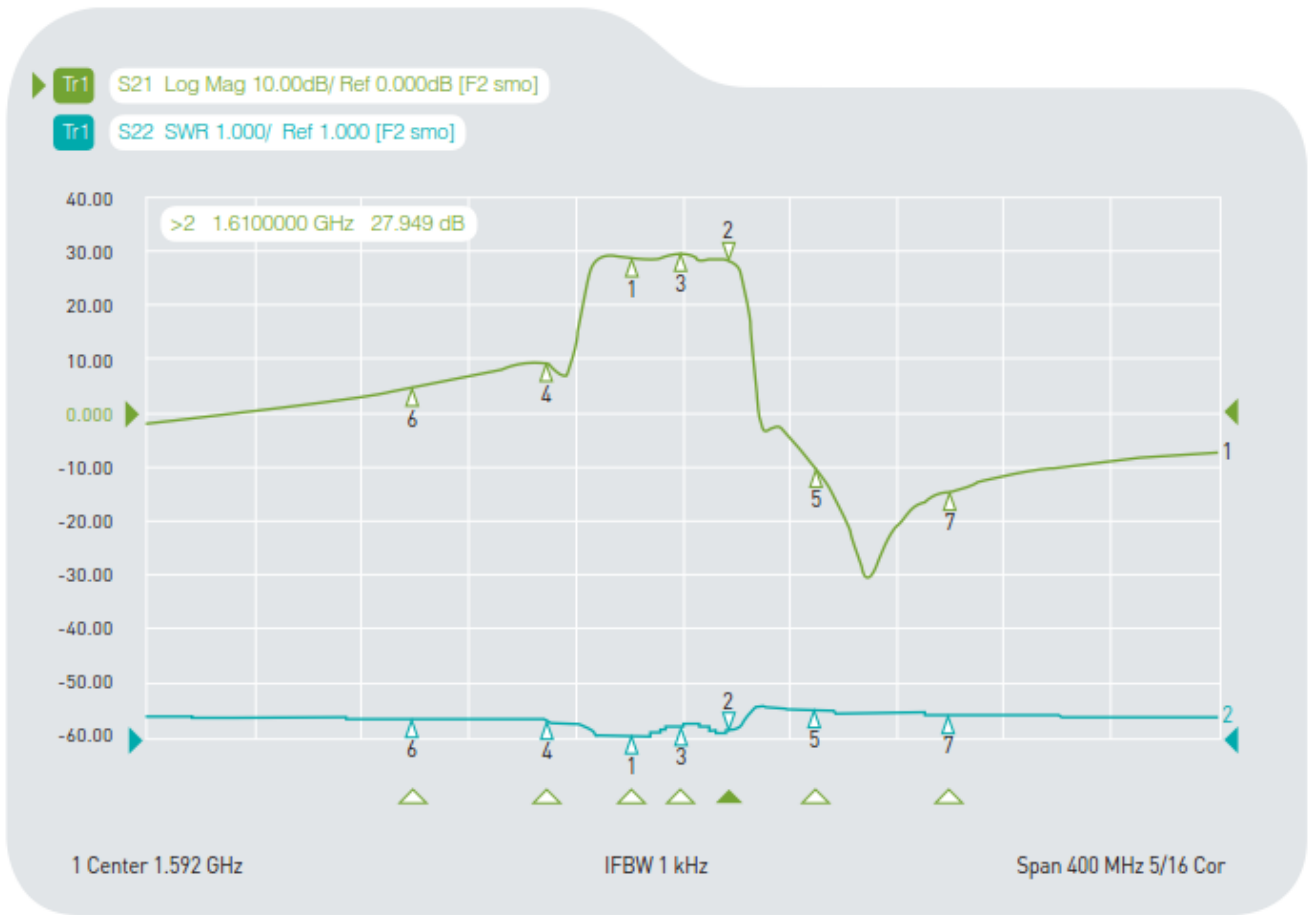

Ch1	Tr1	S21	1	1.5740000 GHz	28.186 dB
Ch1	Tr1	S21	>2	1.6100000 GHz	27.949 dB
Ch1	Tr1	S21	3	1.5920000 GHz	29.044 dB
Ch1	Tr1	S21	4	1.5420000 GHz	9.0245 dB
Ch1	Tr1	S21	5	1.6420000 GHz	-10.035 dB
Ch1	Tr1	S21	6	1.4920000 GHz	4.4105 dB
Ch1	Tr1	S21	7	1.6920000 GHz	-14.431 dB

## 4. LNA Noise Figure @3.0V

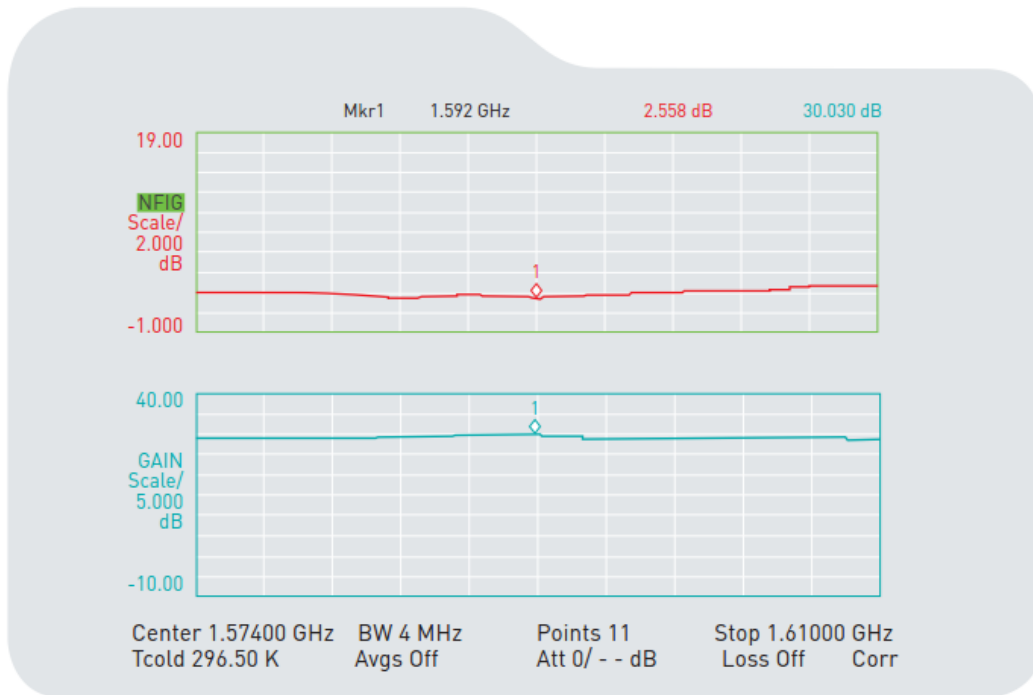

## 5. Total Specification (through Antenna, LNA, Cable and Connector)

Parameter	Specification
Frequency	1574~1610MHz
Gain at 90°	1575.42MHz: 27 ± 3dBic 1602MHz: 28.5 ± 3dBic
Output Impedance	50Ω
Polarization	RHCP
Output VSWR	Max 2.0
Operation Temperature	-40°C to + 85°C
Storage Temperature	-40°C to + 85°C
Relative Humidity	40% to 95%
Input Voltage	Min. 1.8V, Typ. 3.0V, Max. 5V
Antenna	35*35*6.9mm

## 6. Radiation Patterns

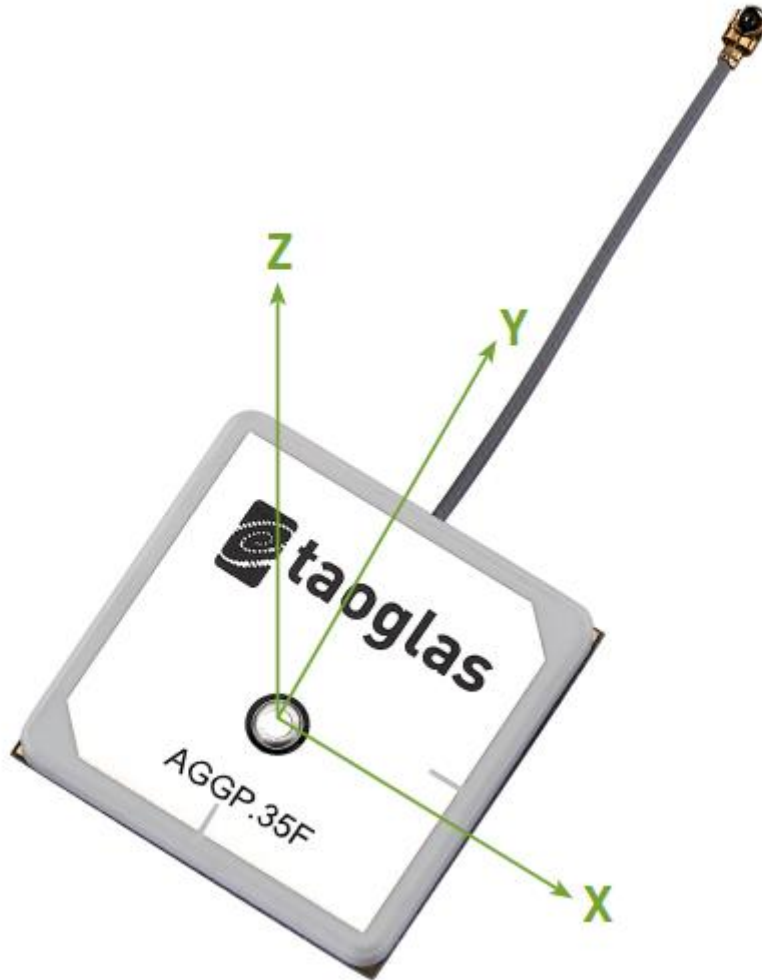

## 6.1. 1575.42MHz

### 6.1.1. XZ & YZ Plane

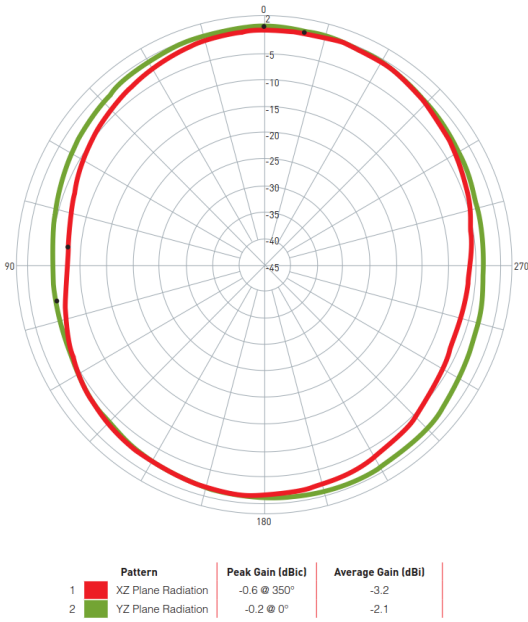

### 6.1.2. XY Plane

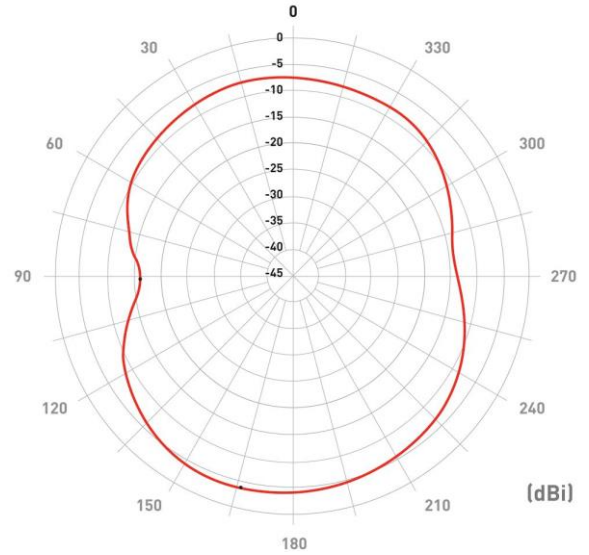

## 6.2. 1602MHz

### 6.2.1. XZ & YZ Plane

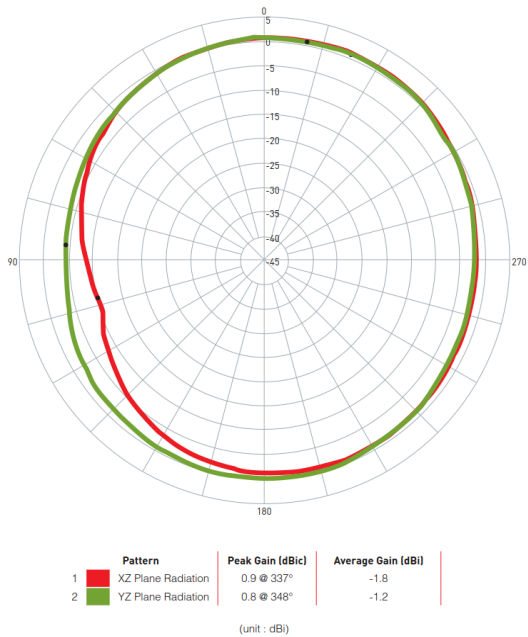

### 6.2.2. XY Plane

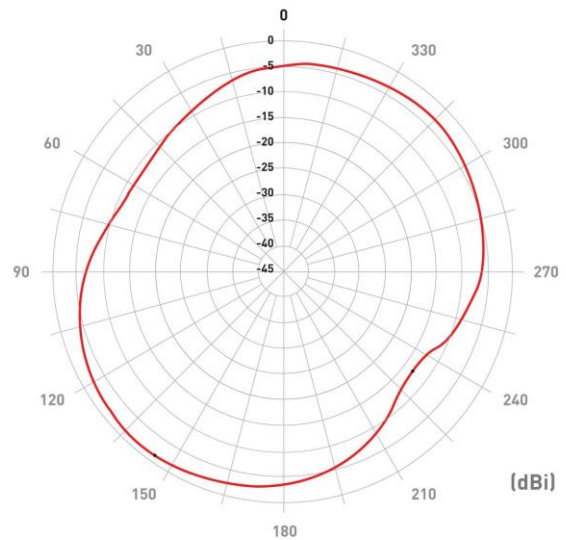

## 7. Plugs Usage Precautions

### 7.1. Mating / Unmating

(1) To disconnect connectors, insert the end portion of I-PEX under the connector flanges and pull off vertically, in the direction of the connector mating axis.

(2) To mate the connectors, the mating axes of both connectors must be aligned and the connectors can be mated. The "click" will confirm fully mated connection. Do not attempt to insert on an extreme angle.

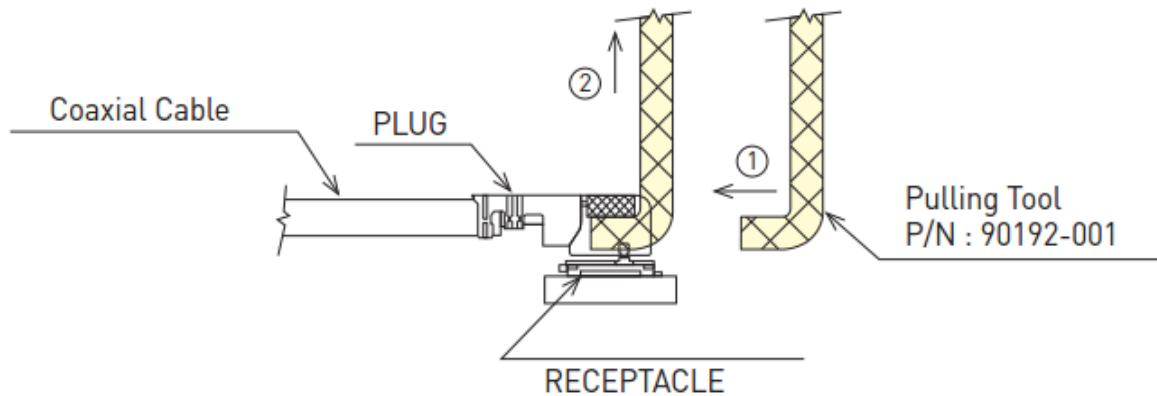

### 7.2. Pull forces on the cable after connectors are mated

After the connectors are mated, do not apply a load to the cable in excess of the values indicated in the diagram below.

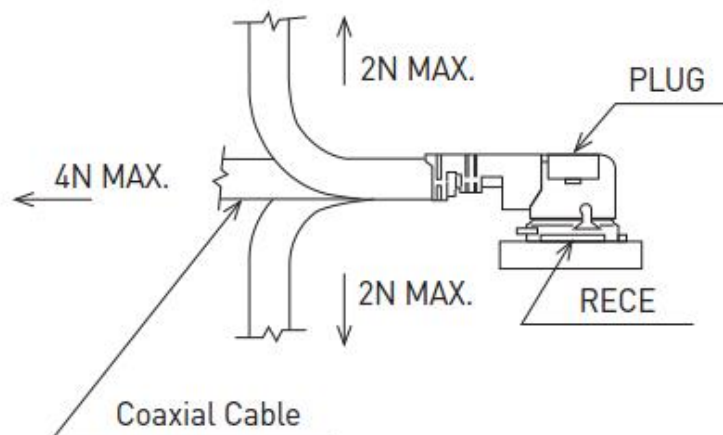



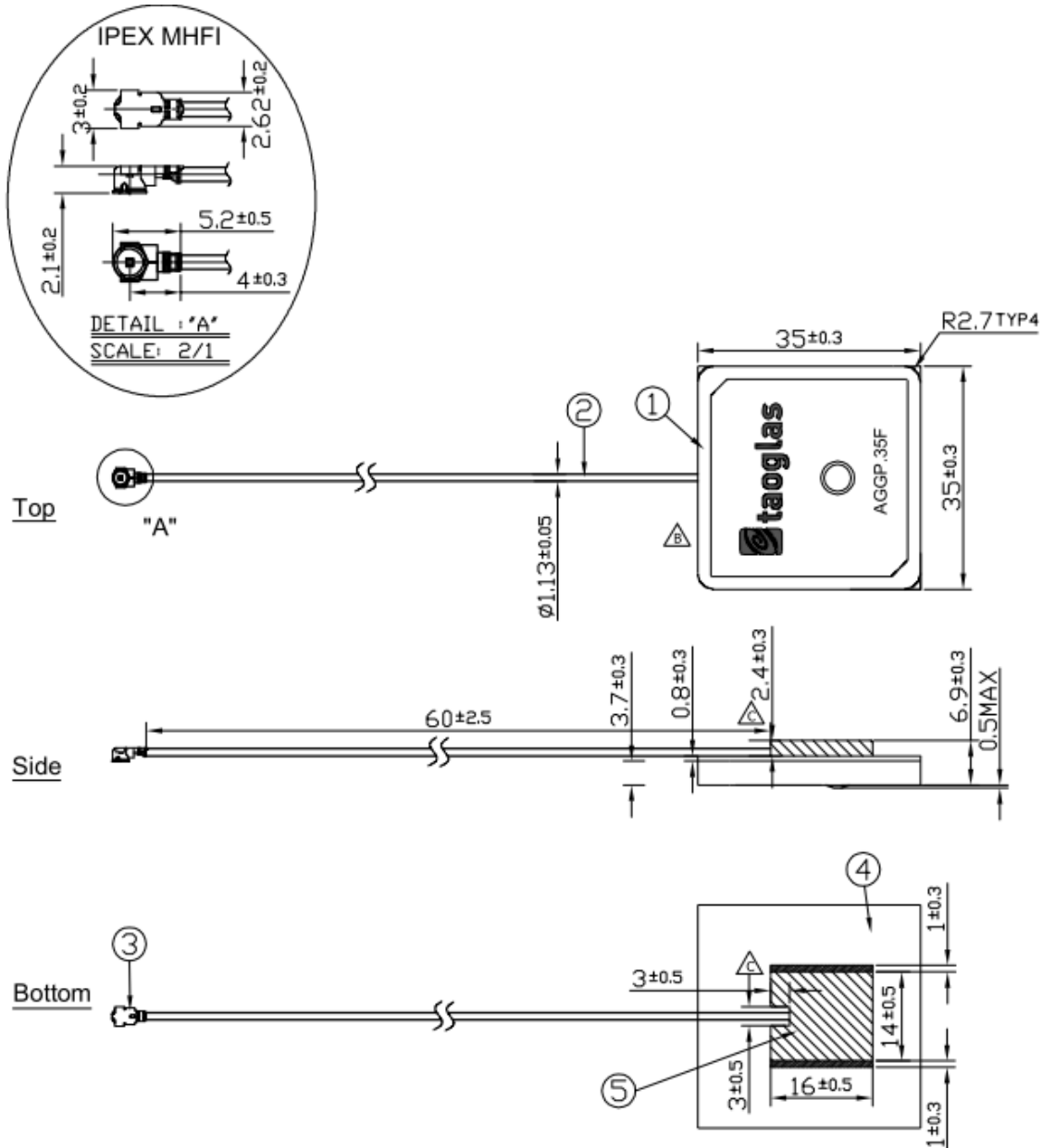

## 8. Technical Drawing



**NOTE:**

1. Soldered area 
2. Shielding case area 
3. All material must be RoHS compliant.
4. The connector orientation has a fixed position to the antenna as per drawing.

	Name	P/N	Material	Finish	QTY
1	AGGP.35F Patch (35*35*3.7mm)	AGGP.35F	Ceramic	Clear	1
2	1.13 Coaxial Cable	OD.113.CM	FEP	Gray	1
3	IPEX MHF1 Connector	IPEX.MHF1.113	Brass	Gold	1
4	PCB		FR4 0.8t	Green	1
5	Shielding Case		(Tin)SPTE	Tin Plated	1

## 9. Packaging

Packaged in plastic tray with foam

Each compartment in tray contains 1 pcs of AGGP.35F

30 pcs of antenna per tray

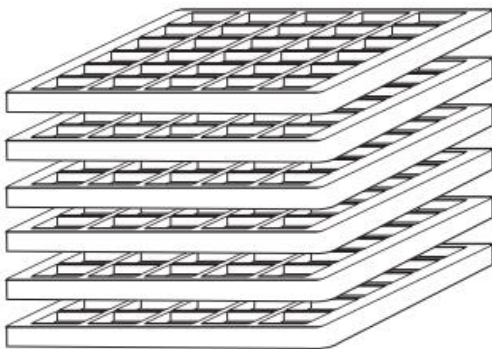

6 trays together in one section

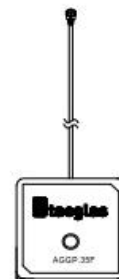

AGGP.35F



Tray

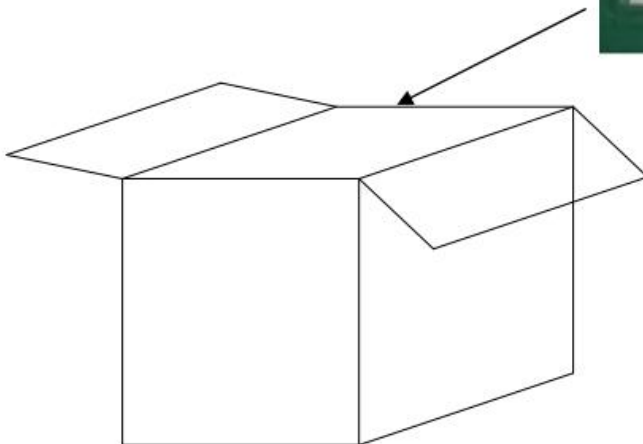

3 sections per carton

540 pcs of antenna per carton

Taoglas makes no warranties based on the accuracy or completeness of the contents of this document and reserves the right to make changes to specifications and product descriptions at any time without notice. Taoglas reserves all rights to this document and the information contained herein.

Reproduction, use or disclosure to third parties without express permission is strictly prohibited.

Copyright © Taoglas Ltd.