



Main

Range of product	Modicon TM5
Product or component type	Analog input module
Analogue input number	2
Analogue input type	Current 0...20 mA/4...20 mA, differential Voltage +/- 10 V, differential
Analogue input resolution	12 bits + sign +/- 10 V 12 bits 0...20 mA/4...20 mA

Complementary

Range compatibility	Modicon LMC058 Modicon M258
Product compatibility	Motion controller Logic controller
Measurement resolution	2.441 mV, +/- 10 V 4.883 µA, 0...20 mA/4...20 mA
Color	White
Input impedance	>= 20 mOhm voltage
Load impedance ohmic	<= 300 Ohm (current)
Sampling duration	1 ms, analogue input type: all inputs with filtering 300 µs, analogue input type: all inputs without filtering
Measurement error	< 0.08 % of full scale, 0...20 mA/4...20 mA at 25 °C < 0.08 % of full scale, +/- 10 V, +/- 10 V at 25 °C
Temperature coefficient	+/- 0.009 %FS/°C, analogue input type: current +/- 0.006 %FS/°C, analogue input type: voltage
Non-linearity	< 0.025 %FS, analogue input type: voltage < 0.05 %FS, analogue input type: current
Type of cable	Shielded cable
Isolation	No insulation between channels 500 Vrms AC insulation between channel and bus
Supply	Internal
[Us] rated supply voltage	24 V DC -15...20 %
Common mode rejection	> 70 dB
Local signalling	1 LED green power supply 1 LED red power supply 2 LEDs green input status
Current consumption	2 mA 5 V DC bus 33 mA 24 V DC input/output
Power dissipation in W	<= 0.81 W
Marking	CE
Product weight	0.06 lb(US) (0.025 kg)

Environment

standards	CSA C22.2 No 142 IEC 61131-2 UL 508 CSA C22.2 No 213
product certifications	CSA C-Tick CULus GOST-R

ambient air temperature for operation	32...122 °F (0...50 °C) (vertical installation) 32...131 °F (0...55 °C) without derating factor (horizontal installation) 32...140 °F (0...60 °C) with derating factor (horizontal installation)
ambient air temperature for storage	-13...158 °F (-25...70 °C)
relative humidity	5...95 % without condensation
IP degree of protection	IP20 conforming to IEC 61131-2
pollution degree	2 conforming to IEC 60664
operating altitude	0...6561.68 ft (0...2000 m)
storage altitude	0...9842.52 ft (0...3000 m)
vibration resistance	1 gn (f= 8.4...150 Hz) DIN rail 3.5 mm (f= 5...8.4 Hz) DIN rail
shock resistance	15 gn 11 ms
resistance to electrostatic discharge	4 kV on contact conforming to EN/IEC 61000-4-2 8 kV in air conforming to EN/IEC 61000-4-2
resistance to electromagnetic fields	0.91 V/yd (1 V/m) 2...2.7 GHz conforming to EN/IEC 61000-4-3 9.14 V/yd (10 V/m) 80...2000 MHz conforming to EN/IEC 61000-4-3
resistance to fast transients	1 kV I/O conforming to EN/IEC 61000-4-4 1 kV shielded cable conforming to EN/IEC 61000-4-4 2 kV power lines conforming to EN/IEC 61000-4-4
surge withstand	0.5 kV differential mode conforming to EN/IEC 61000-4-5 1 kV common mode conforming to EN/IEC 61000-4-5
electromagnetic compatibility	EN/IEC 61000-4-6
disturbance radiated/conducted	CISPR 11

Offer Sustainability

Green Premium product	Green Premium product
Compliant - since 1039 - Schneider Electric declaration of conformity	Compliant - since 1039 - Schneider Electric declaration of conformity
Reference not containing SVHC above the threshold	Reference not containing SVHC above the threshold
Available	Available
Available	Available
WARNING: This product can expose you to chemicals including:	WARNING: This product can expose you to chemicals including:
Lead and lead compounds, which is known to the State of California to cause cancer and birth defects or other reproductive harm.	Lead and lead compounds, which is known to the State of California to cause cancer and birth defects or other reproductive harm.
For more information go to www.p65warnings.ca.gov	For more information go to www.p65warnings.ca.gov

Contractual warranty

Warranty period	18 months
-----------------	-----------

TM5 Slice

Dimensions

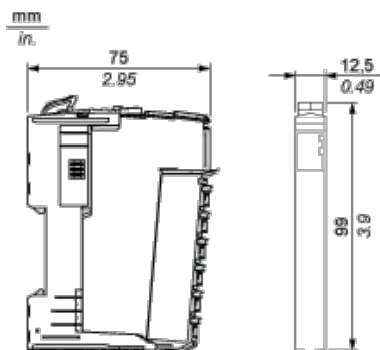

TM5 System

Spacing Requirements

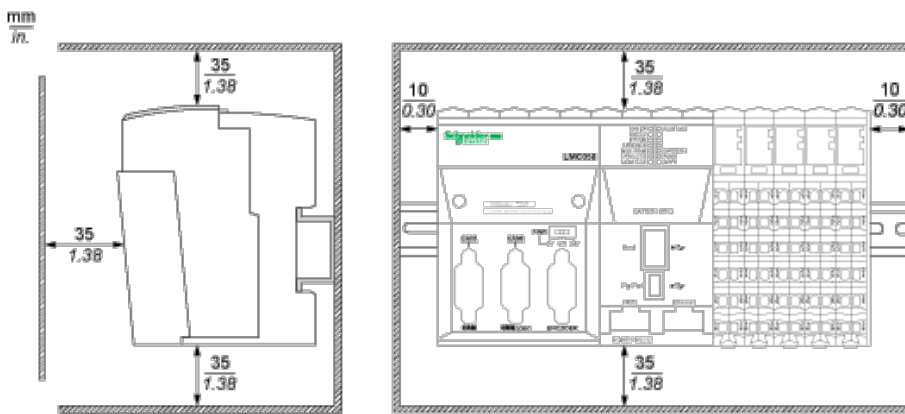

Mounting on a DIN Rail

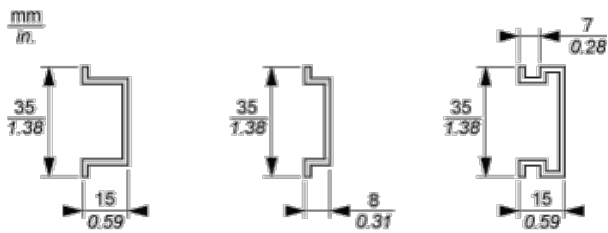

TM5 System Wiring Recommendations

Wire Sizes to Use with the Removable Spring Terminal Blocks

mm in.				
mm ²	0,08...2,5	0,25...2,5	0,25...1,5	2 x 0,25...2 x 0,75
AWG	28...14	24...14	24...16	2 x 24...2 x 18

Electronic Module 2AI ±10V/0-20mA/4-20mA 12 Bits

Wiring Diagram

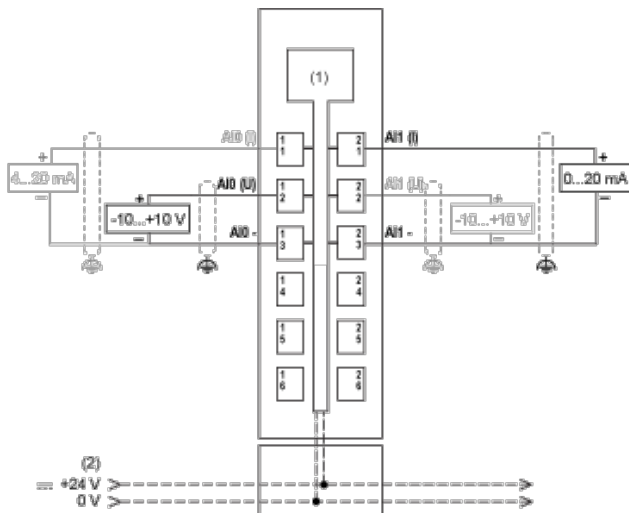

- (1) Internal electronics
- (2) 24 Vdc I/O power segment integrated into the bus bases
- (I) Current
- (U) Voltage