

EE-SX1320

Ultra-Compact Slot / SMD Type (Slot width: 2 mm)

- PCB surface mounting type.
- High resolution with a 0.3-mm-wide aperture.

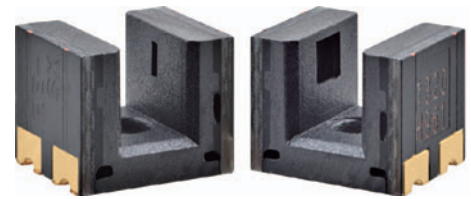

Be sure to read *Safety Precautions* on page 3.

Ordering Information

Photomicrosensor

Appearance	Sensing method	Connecting method	Sensing distance	Aperture size (H × W) (mm)	Output type	Model
	Transmissive (slot type)	SMT	2 mm (slot width)	Emitter 1.4 × 1.4 Detector 1 × 0.3	Phototransistor	EE-SX1320

Ratings, Characteristics and Exterior Specifications

Absolute Maximum Ratings (Ta = 25°C)

Item	Symbol	Rated value	Unit
Emitter			
Forward current	I_F	25 *1	mA
Pulse forward current	I_{FP}	100 *2	mA
Reverse voltage	V_R	5	V
Detector			
Collector-Emitter voltage	V_{CEO}	12	V
Emitter-Collector voltage	V_{ECO}	5	V
Collector current	I_C	20	mA
Collector dissipation	P_C	75 *1	mW
Operating temperature	T_{opr}	-30 to +85 *1	°C
Storage temperature	T_{stg}	-40 to +90 *1	°C
Reflow soldering temperature	T_{sol}	255 *3	°C

*1. Refer to the temperature rating chart if the ambient temperature exceeds 25°C.

*2. Duty ratio: 1%, Pulse width: 0.1 ms

*3. Complete soldering within 10 seconds for reflow soldering.

Exterior Specifications

Connecting method	Weight (g)	Material
		Case
SMT	0.1	PPS

Electrical and Optical Characteristics (Ta = 25°C)

Item	Symbol	Value			Unit	Condition
		MIN.	TYP.	MAX.		
Emitter						
Forward voltage	V_F	---	1.1	1.3	V	$I_F = 5 \text{ mA}$
Reverse current	I_R	---	---	10	μA	$V_R = 5 \text{ V}$
Peak emission wavelength	λ_P	---	940	---	nm	$I_F = 20 \text{ mA}$
Detector						
Light current	I_L	150	---	1500	μA	$I_F = 5 \text{ mA}$, $V_{CE} = 5 \text{ V}$
Dark current	I_D	---	10	100	nA	$V_{CE} = 10 \text{ V}$, $I_L = 0$
Collector-Emitter saturated voltage	$V_{CE}(\text{sat})$	---	0.1	0.4	V	$I_F = 20 \text{ mA}$, $I_L = 50 \mu\text{A}$
Peak spectral sensitivity wavelength	λ_P	---	900	---	nm	$V_{CE} = 5 \text{ V}$
Rising time	t_r	---	19	---	μs	$V_{CC} = 5 \text{ V}$, $R_L = 100 \Omega$, $I_L = 500 \mu\text{A}$
Falling time	t_f	---	26	---	μs	$V_{CC} = 5 \text{ V}$, $R_L = 100 \Omega$, $I_L = 500 \mu\text{A}$

Note: Refer to the following timing diagram for t_r and t_f .

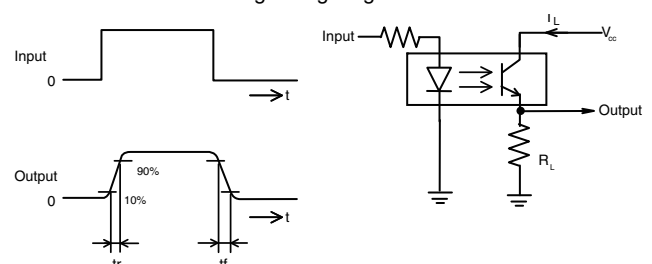

Engineering Data (Reference value)

Fig 1. Forward Current vs. Collector Dissipation Temperature Rating

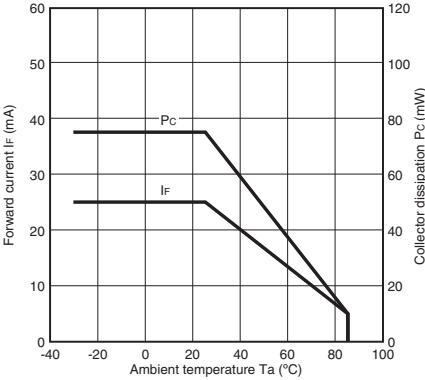

Fig 2. Forward Current vs. Forward Voltage Characteristics (Typical)

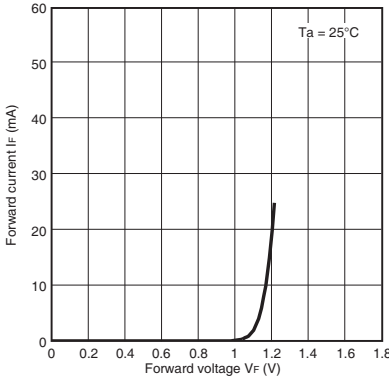

Fig 3. Light Current vs. Forward Current Characteristics (Typical)

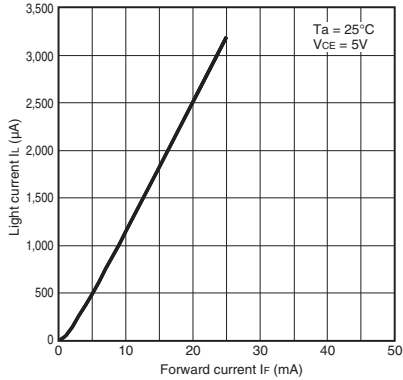

Fig 4. Light Current vs. Collector-Emitter Voltage Characteristics (Typical)

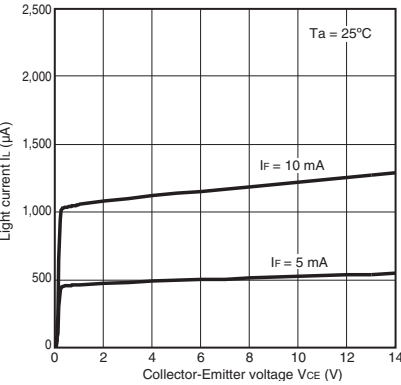

Fig 5. Relative Light Current vs. Ambient Temperature Characteristics (Typical)

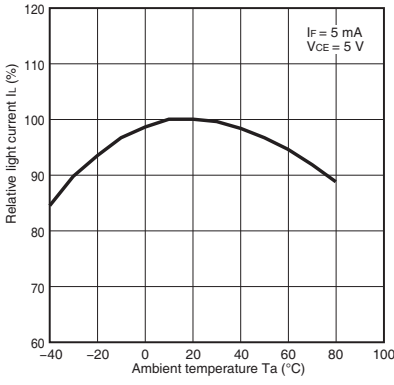

Fig 6. Dark Current vs. Ambient Temperature Characteristics (Typical)

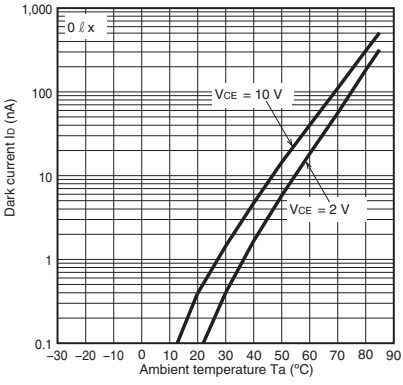

Fig 7. Response Time vs. Load Resistance Characteristics (Typical)

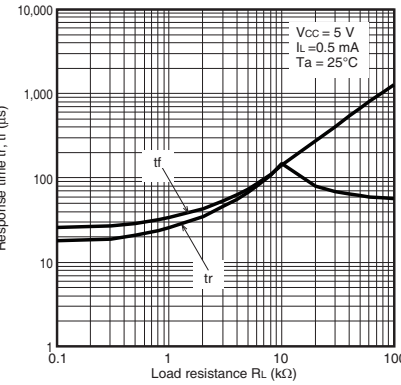

Fig 8. Sensing Position Characteristics (Typical)

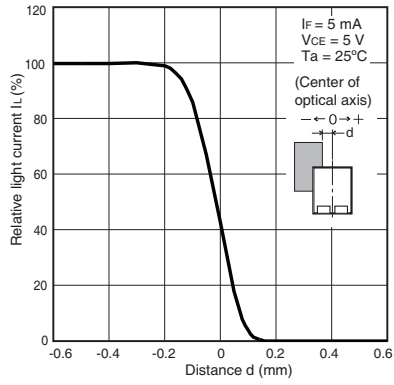
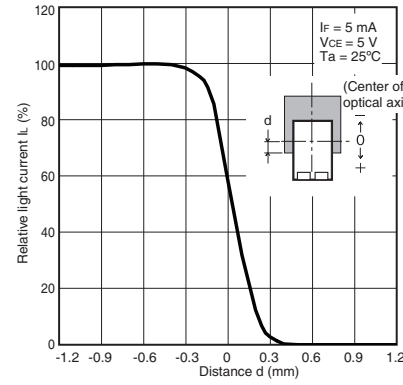

Fig 9. Sensing Position Characteristics (Typical)



Safety Precautions

To ensure safe operation, be sure to read and follow the Instruction Manual provided with the Sensor.

⚠ CAUTION

This product is not designed or rated for ensuring safety of persons either directly or indirectly. Do not use it for such purposes.

Precautions for Correct Use

Do not use the product in atmospheres or environments that exceed product ratings. This product is for surface mounting. Refer to Soldering Information, Storage and Baking for details.

Dispose of this product as industrial waste.

Precautions for Safe Use

Do not use the product with a voltage or current that exceeds the rated range.

Applying a voltage or current that is higher than the rated range may result in explosion or fire.

Do not miswire such as the polarity of the power supply voltage.

Otherwise the product may be damaged or it may burn.

This product does not resist water. Do not use the product in places where water or oil may be sprayed onto the product.

Dimensions and Internal Circuit

(Unit: mm)

Photomicrosensor

EE-SX1320

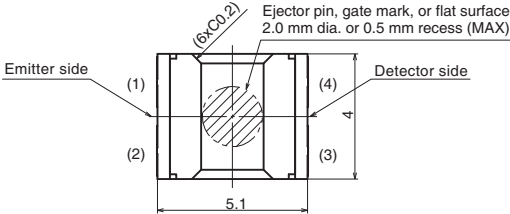

Aperture size (H x W)

Emitter	Detector
1.4x1.4	1x0.3

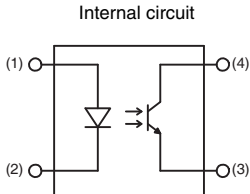
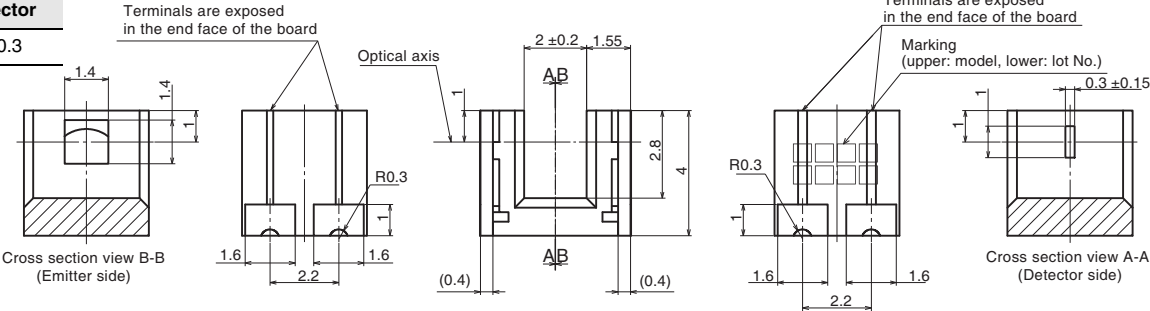

Terminal No.	Name
(1)	Anode
(2)	Cathode
(3)	Emitter
(4)	Collector

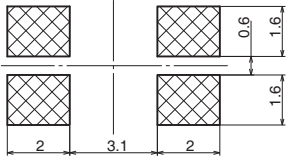

Unless otherwise specified, the tolerances are ±0.2 mm.

Tape and Reel

Reel (Unit: mm) *

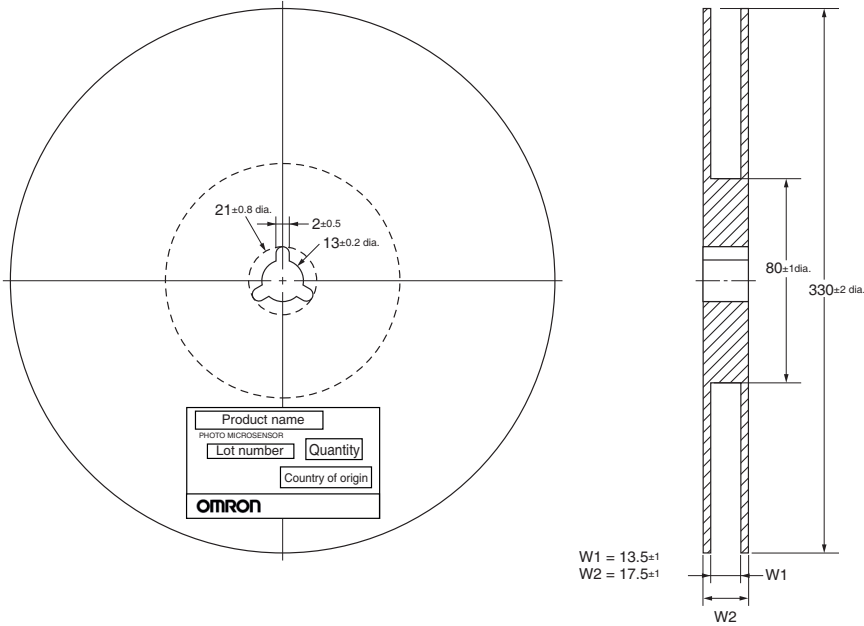

Tape (Unit: mm)

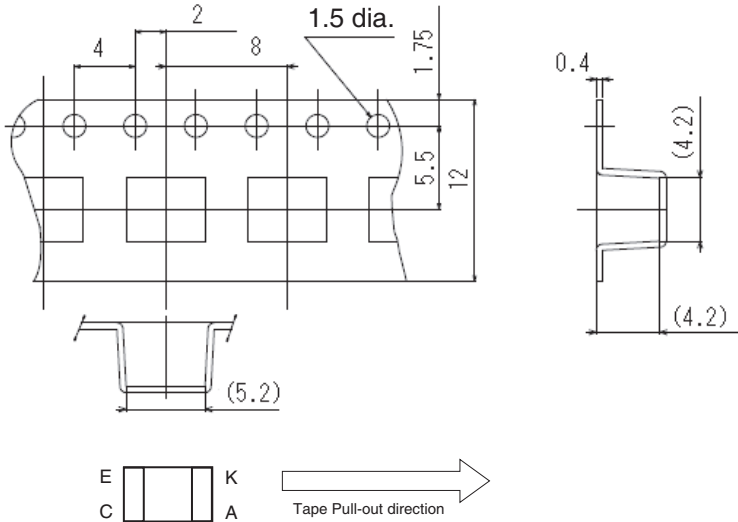

Note: Direction of product packing is upper figure.

Tape quantity

2,000 pcs./reel

100 pcs./pack *

* EE-SX1320-1 (100 pcs./pack) has no reel, only tape is attached.

Soldering Information

Reflow soldering: Temperature profile

1. The reflow soldering can be implemented in two times complying with the following diagram.
All the temperatures in the product must be within the diagram.
2. The recommended thickness of the metal mask for screen printing is between 0.2 and 0.25 mm.

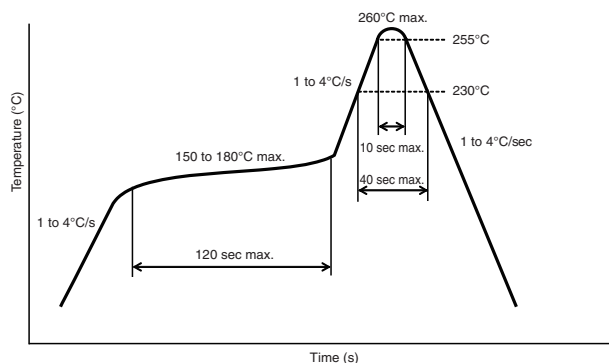

Manual soldering

The manual soldering should not be applied to the products, otherwise the housing may be deformed and/or the Au plating may be peeled off by heat.

Other notes

The use of infrared lamp causes the temperature at the resin to rise particularly too high.

All the temperatures in the product must be within the above diagram. Do not immerse the resin part into the solder. Even if within the above temperature diagram, there is a possibility that the gold wire in the products is broken in case that the deformation of PC board gives stress to the products.

Please confirm the conditions (including material and method of flux and cleaning) of the reflow soldering fully by actual solder reflow machine prior to the mass production use.

Storage

Storage conditions

To protect the product from the effects of humidity until the package is opened, dry-box storage is recommended. If this is not possible, store the product under the following conditions:

- Temperature: 10 to 30 °C
- Humidity: 60% RH max.

Treatment after open

1. Reflow soldering must be done within 48 hours stored at the conditions of humidity 60% RH or less and temperature 10 to 30°C.
2. If the product must be stored after it is unpacked, store it in a dry box or reseal it in a moisture-proof package with desiccant at a temperature of 10 to 30°C and a humidity of 60% RH or less. Even then, mount the product within one week.

Baking

In case that it could not carry out the above treatment, it is able to mount by the following baking treatment. However baking treatment shall be limited only 1 time.

- Recommended conditions: 60°C for 24 to 48 hours (reeled one)
- 100°C for 8 to 24 hours (loose one)

- Application examples provided in this document are for reference only. In actual applications, confirm equipment functions and safety before using the product.
- Consult your OMRON representative before using the product under conditions which are not described in the manual or applying the product to nuclear control systems, railroad systems, aviation systems, vehicles, combustion systems, medical equipment, amusement machines, safety equipment, and other systems or equipment that may have a serious influence on lives and property if used improperly. Make sure that the ratings and performance characteristics of the product provide a margin of safety for the system or equipment, and be sure to provide the system or equipment with double safety mechanisms.

Note: Do not use this document to operate the Unit.

Mouser Electronics

Authorized Distributor

Click to View Pricing, Inventory, Delivery & Lifecycle Information:

[Omron:](#)

[EE-SX1320](#)