

R516 series: the RAMSES concept merges with the SLIM LINE technology, breaking up the frequency limits of SMT switches :

- FULL SMT TECHNOLOGY COMPATIBLE
- High frequency
- High life span
- High repeatability
- High power applications

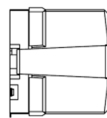

(All dimensions are in mm [inches])

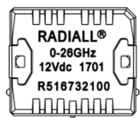
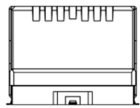

ACTUAL SIZE

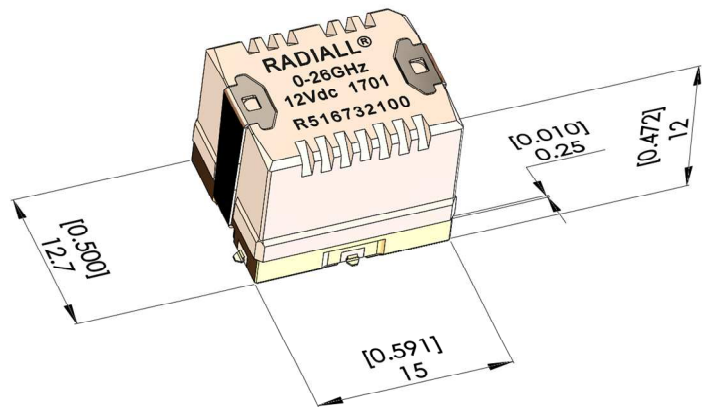

TYPICAL OUTLINE DRAWING

PART NUMBER SELECTION

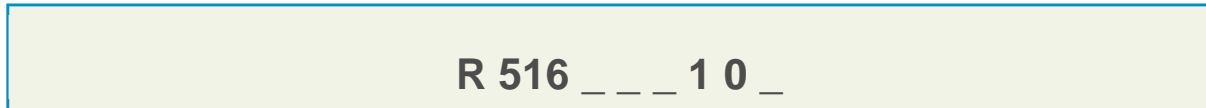

Frequency range :
 3 : DC – 8GHz
 4 : DC – 18GHz
 7 : DC – 26.5GHz

TYPE :
 3 : Latching, 2 coils

ACTUATOR VOLTAGE :
 1 : 6Vdc
 2 : 12Vdc
 3 : 24Vdc

Actuator terminals :
 0 : Not soldered
 T : Soldered on a connectorized test fixture (1)

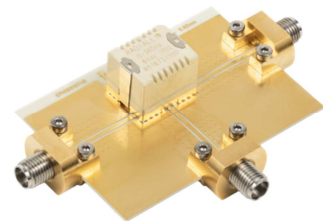

(1) See details about test fixture RF characteristics on page 3

PAGE 2/6	ISSUE Jul-24-2017	SERIES Micro-SPDT	PART NUMBER R516 XXX 10X
----------	-------------------	-------------------	--------------------------

GENERAL SPECIFICATION

Operating mode		Latching (Type 3)		
Nominal operating voltage (Vdc) (across operating temperature range)		6 (on request) (5.1 to 6.6)	12 (10.2 to 13)	24 (20.5 to 30)
Coil resistance (+/-10%) (Ohms)		55	205	865
Operating current at 23°C (mA)		108	58	32
RF and command ports		gold plated access, infrared reflow, forced air oven or hand soldering (Compatible with "lead free" soldering processes)		
Switching time (Nomial voltage)	Making contacts	Max 5ms, including contact bounce time		
	Breaking contacts	3ms		
Life	Cold switching (Max 120 cycles/min)	3 million cycles (5 million cycles typical at low level)		
	Hot switching (Max 20 cycles/min)	500.000 cycles (1W, impedance 50Ω , V.S.W.R. <1.25)		
Insulation		Dielectric test voltage	300Vrms	
		Insulation resistance at 500Vdc	> 100MOhms	
Environmental protection		"LEAD FREE » construction" Waterproofness according to IEC 60529 / IP64		
Mass		8g		
Operating temperature range (°C) (With no icing nor condensation)		- 40 to +85		
Storage temperature range (°C)		-55 to +85		

PIN IDENTIFICATION (TOP VIEW)

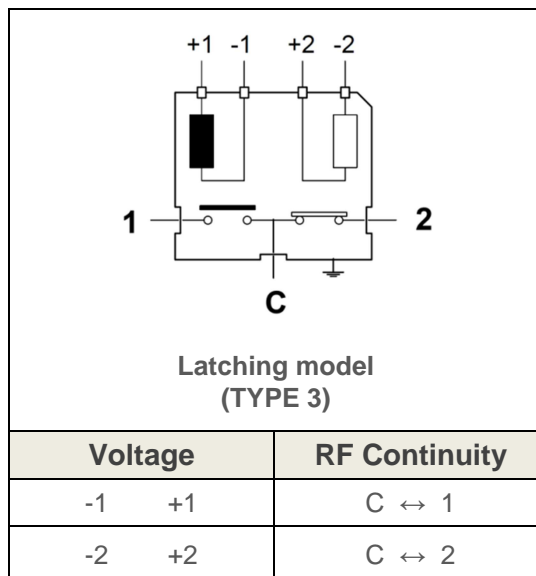

RF PERFORMANCES (1)

Frequency Range (GHz)		V.S.W.R	IL	Isolation (min) dB		Average power W	Third order Inter modulation	Impedance
		(max)	(max) dB	switch alone	switch+board layout (1)	hot switching		Ohms
DC – 8 DC – 18 DC – 26.5	DC – 3	1.20	0.20	50	50	40	-110 dBc Typical @ 1730 MHz (2 carriers 20W)	50
	3 – 6	1.35	0.40	40	40	25		
	6 – 8	1.40	0.50	40	40	5		
	8 – 12.4	1.50	0.60	40	30	3		
	12.4 – 18	1.70	1.00	40	30	1		
	18 – 26.5	2.00	1.60	40	30	1		

(1) : at high frequency, manual soldering may generate spikes and RF characteristics degradation, due to air gaps between PC board and relay ground.

TYPICAL RF PERFORMANCE - MEASUREMENT METHOD USING UOSM 2.92mm CALIBRATION

2.92mm UOSM calibration is performed to extract RF performances of SMT relay. **VSWR values are those of the complete evaluation board** (Relay + coaxial connectors and microstrip access lines). **Insertion loss values are those of the relay by subtracting the loss of an equivalent length of microstrip access line.**

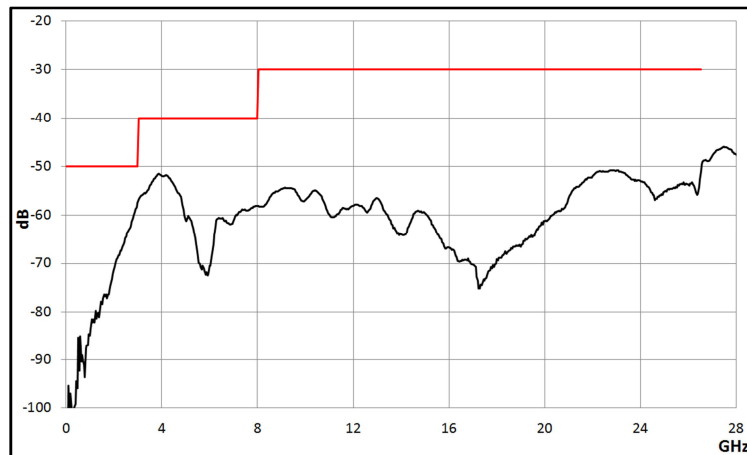
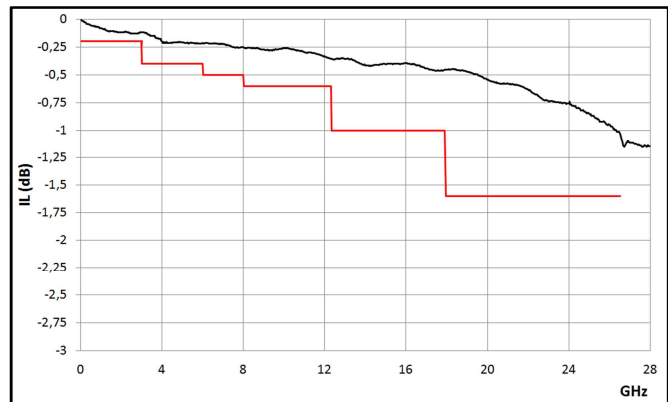
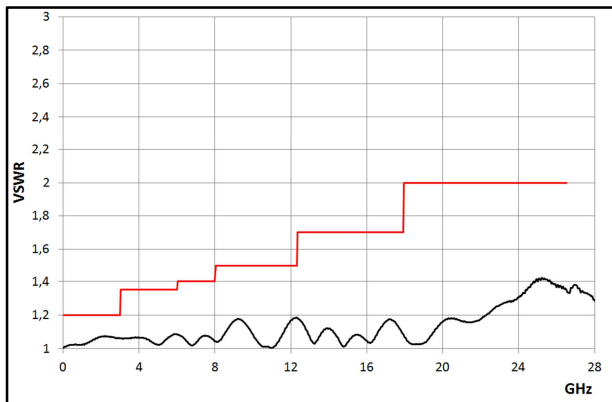

RF POWER RATING FOR COLD SWITCHING USE

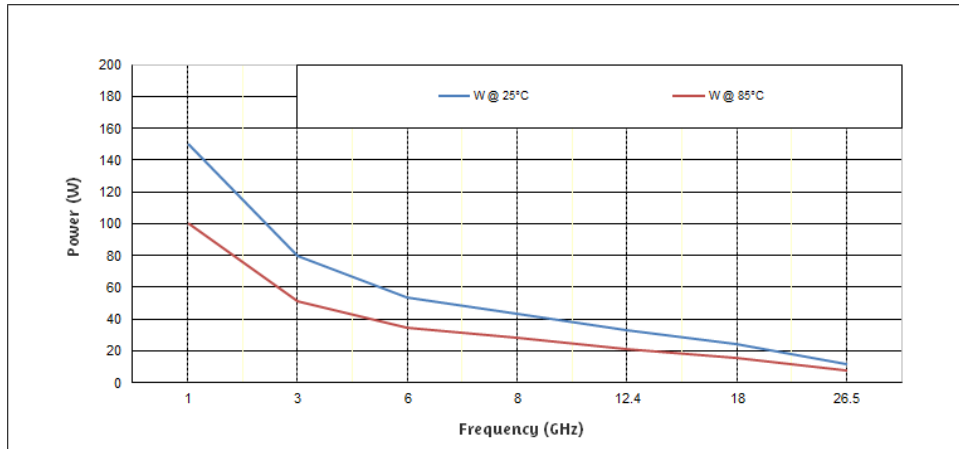

RELAY PACKAGING

For relays soldered on test fixture: individual packaging

For not soldered relays:

For quantities up to 50 relays: packaged in tape without reel

For upper quantities: packaged in tape and reel, maximum **200** relays per reel

ACCORDING TO IEC 286-3 STANDARD

MATERIALS

Reel : polyester

Carrier tape : PVC

Cover tape : polyester

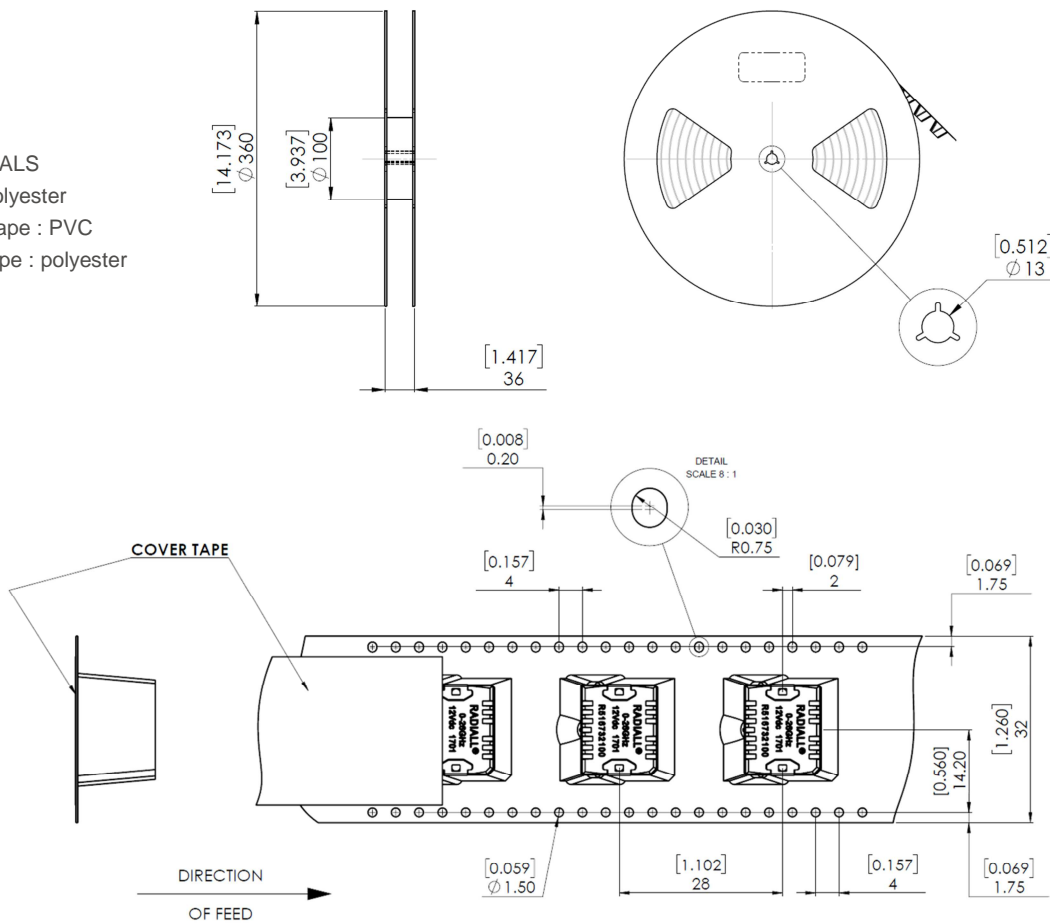

PAGE 5/6	ISSUE Jul-24-2017	SERIES Micro-SPDT	PART NUMBER R516 XXX 10X
----------	-------------------	-------------------	--------------------------

Video shadow of the relay



Aspiration area [0,315]
∅ 8

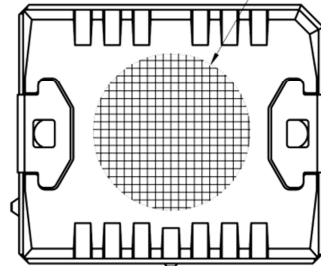

PC BOARD MOUNTING

Substrate Types

Recommended substrates are ROGERS RO4003.,

Thickness 0.508 mm Cu double side 17.5µm.

Recommended total thickness of RF tracks (copper over thickness + plating) : 40µm.

Other substrates may be used (1)

Board layout general outline

DXF or GERBER format file

Available upon request (1)

Relay soldering

DXF format file available upon request (1)

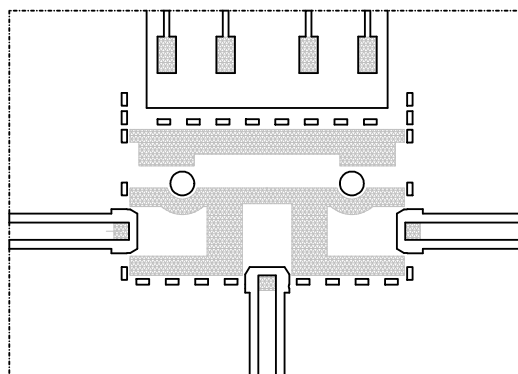

 Area for solder paste

(1) : Please contact us by E-mail : switchingproducts@radiall.com

RECOMMENDED SOLDERING PROCEDURE

A – Soldering procedure using automatic pick and place equipment

1-Solder paste :

R516 series are « Lead Free », and Lead Free Sn-Ag3.5-Cu0.7 solder cream may be used as well as standard Sn63–Pb35–Ag2. RADIALL recommends using a « no clean - low residue » solder cream (5% solid residue of flux quantity) that will permit the elimination of the cleaning operation step after soldering.

Note : Due to the gold plating of the switch PCB interface, it is important to use a paste made with silver. This will help in avoiding formation of intermetallics as part of the solder joint.

2-Solder paste deposition :

Solder cream may be applied on the board with screen printing or dispenser technologies. For either method, the solder paste must be coated to appropriate thickness and shapes to achieve good solder wetting. Please optically verify that the edges of the zone are clean and without contaminates, and that the PCB zoned areas have not oxydated. The design of the mounting pads and the stenciling area are available upon request, for a thickness of the silk-screen printing of **0.15 mm (0.006 ”)**.

3-Placement of the component :

For small lightweight components such as chip components, a self-alignment effect can be expected if small placement errors exist. However, this effect is not as expected for relays components and they require an accurate positioning on their soldering pads, typically +/- 0.1mm (+/-0.004”).

Place the relay onto the PCB with automatic pick and place equipment. Various types of suction can be used.

RADIALL does not recommend using adhesive agents on the component or on the PCB.

4-Soldering : infra-red process

Please follow the RADIALL recommended max temperature profile for infra-red reflow or forced air convection :

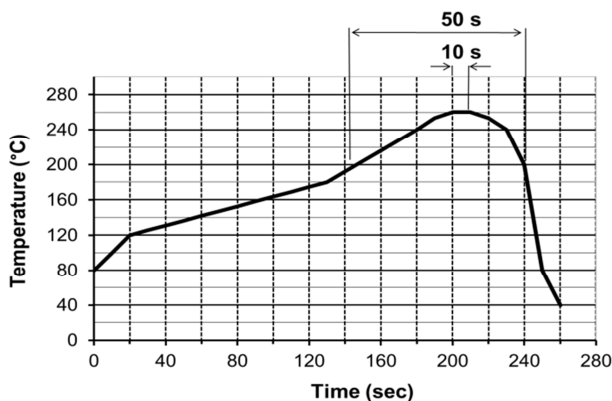

Higher temperature (>260°C) and longer process duration would damage permanently the switches.

5-Cleaning procedure :

On miniature relays, high frequency cleaning may cause the contacts to stick. If cleaning is needed, please avoid ultrasonic cleaning and use alcohol based cleaning solutions.



In-line cleaning process, spraying, immersion, especially under temperature, may cause a risk of degradation of internal contacts. For such cleaning process please contact us.

6-Quality check :

Verify by visual inspection that the component is centred on the mounting pads.

Solder joints : verify by visual inspection that the formation of meniscus on the pads are proper.

B – Soldering procedure by manual operation



: manual soldering is not recommended for high frequencies, as it generates resonance and lower RF characteristics due to gaps between PC board and relay grounds,.

1-Solder paste and flux deposition :

Refer to procedure A – 1

Deposite a thin layer of flux on mounting zone.

Allow the flux to evaporate a few seconds before applying the solder paste, in order to avoid dilution of the paste.

2-Solder paste deposition :

RADIALL recommends depositing a small amount of solder paste on the pads solder area by syringe, according to the manual soldering pattern (available upon request).

Be careful, not to apply solder paste outside of the zone area.

3-Placement of the component :

During manipulation, avoid contaminating gold surfaces by contact with fingers.

Place the component on the mounting zone by pressing on the top of the relay lid.

4-Hand soldering :

Iron wattage 30 to 60 W.

To keep better RF characteristics, apply pressure on the relay lid during all the soldering stage, so as to reduce the air gap between the PC board and the relay.

To improve RF characteristics, fix the ground plane of the relay on the board with two M1.2 screws before the soldering stage. On each side of the central RF access, the RF body edge must be soldered to the ground of the PC board.

5-Cleaning procedure :

Refer to procedure A – 5.

6-Quality check:

Verify by visual inspection that component is centred on the mounting pads.

Solder joints : verify by visual inspection that there is no solder excess on the RF pads.