

PRODUCT NO.
10027747-X1XXXX

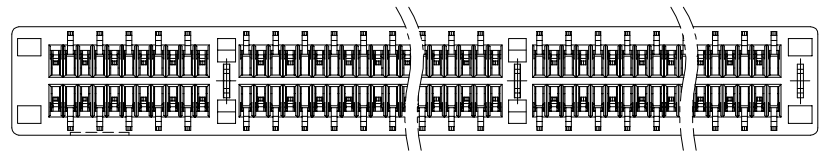
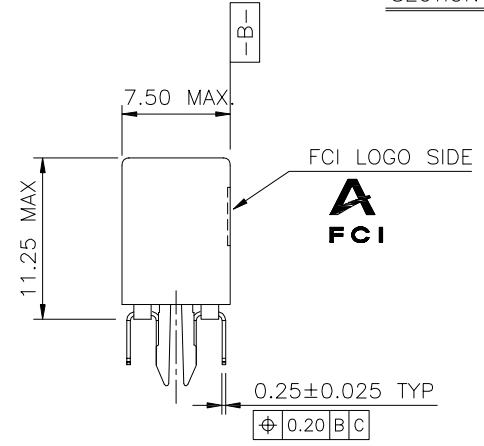
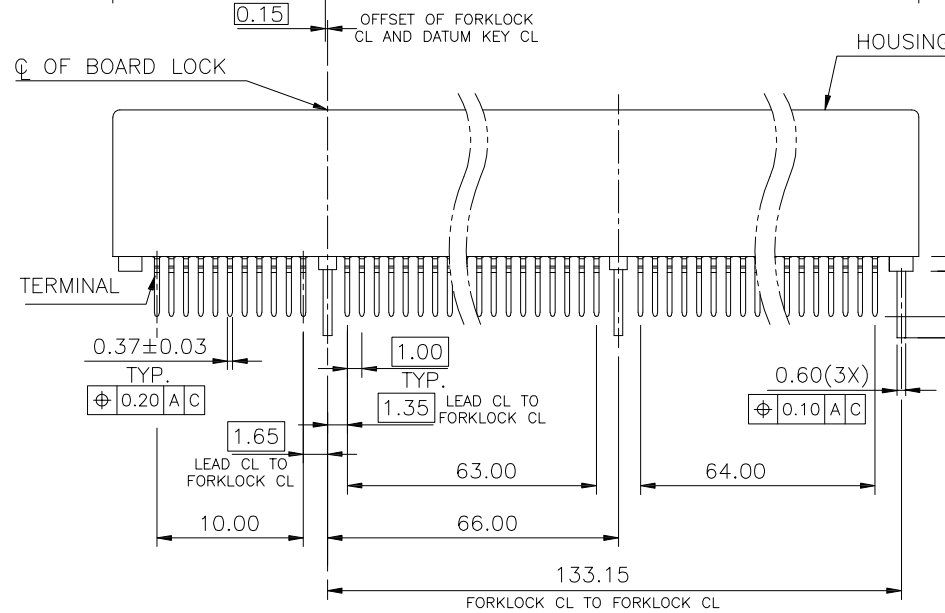
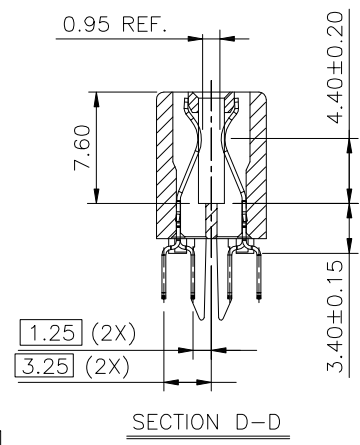
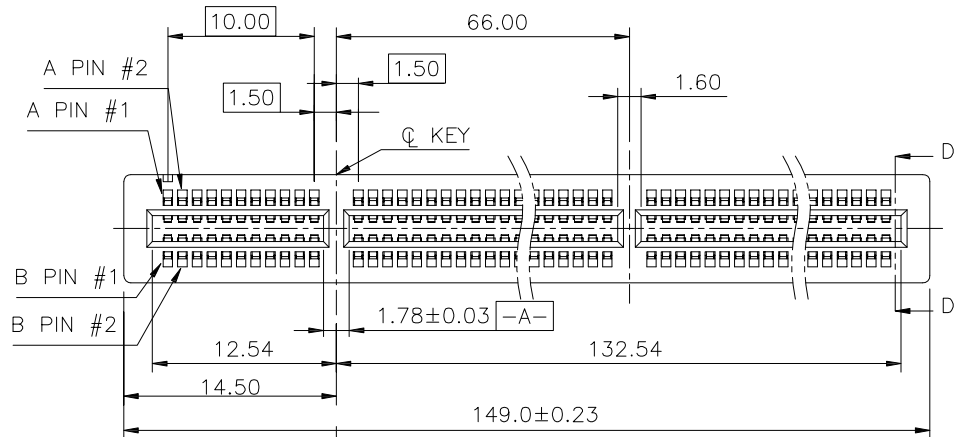

CONFIDENTIAL

mat'l. code		tolerances unless otherwise specified				CUSTOMER COPY		FCI www.fciconnect.com	
ltr	ecn no	dr	date	linear	.X ± 0.30	projection	title	PCI EXPRESS GEN3 CARD EDGE ASSY 280P	
A	T04-0386	M W	10/07/04		.XX ± 0.20	MM		product family	EDGE CARD
B	T04-0427	M W	12/10/04	angles	.XXX ± 0.10		scale	size	dwg no
C	T05-0010	M W	01/11/05		0° ± 2°	2:1		A4	10027747
D	ELX-DG-21161-1	S T	05/27/15	dr	STONE LI		05/27/15		
-	-	-	-	enr	STONE LI	05/27/15			
				chr	/	/			
				appd	PM ZHENG	05/27/15			
sheet index	revision sheet	D 1	D 2	D 3	D 4				

cage code
22526

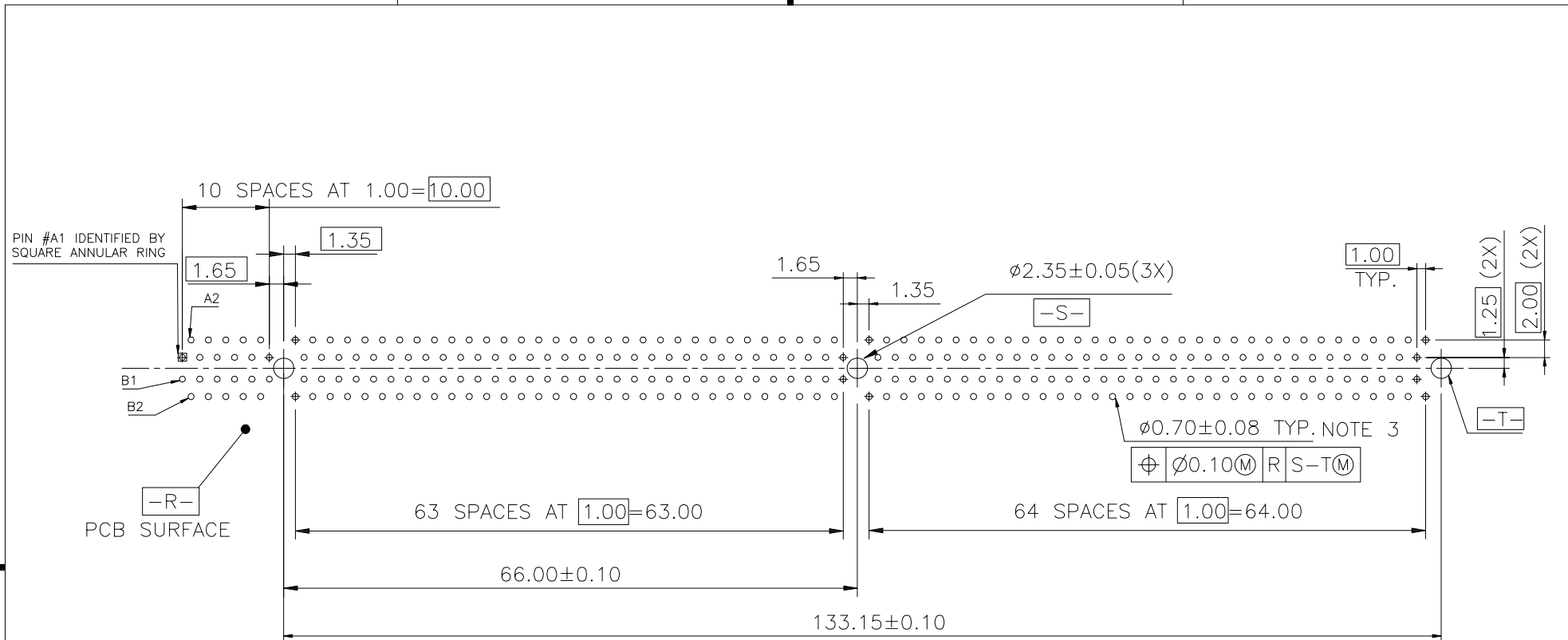

MOTHER BOARD FOOTPRINT PATTERN
CONNECTOR SIDE SHOWN

CONFIDENTIAL

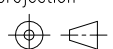
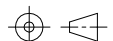
mat'l. code				tolerances unless otherwise specified		CUSTOMER COPY	 www.fciconnect.com		
ltr	ecn no	dr	date	linear	.X ±			projection	title PCI EXPRESS GEN3  CARD EDGE ASS'Y 280P
					.XX ±	 MM	product family	EDGE CARD	
				angles	.XXX ±		scale	size	dwg no
				dr	0° ±2°	1.5:1		A4	10027747
				enr					2 of 4
				chr					
				appd					
sheet index		revision sheet							

cage code
22526

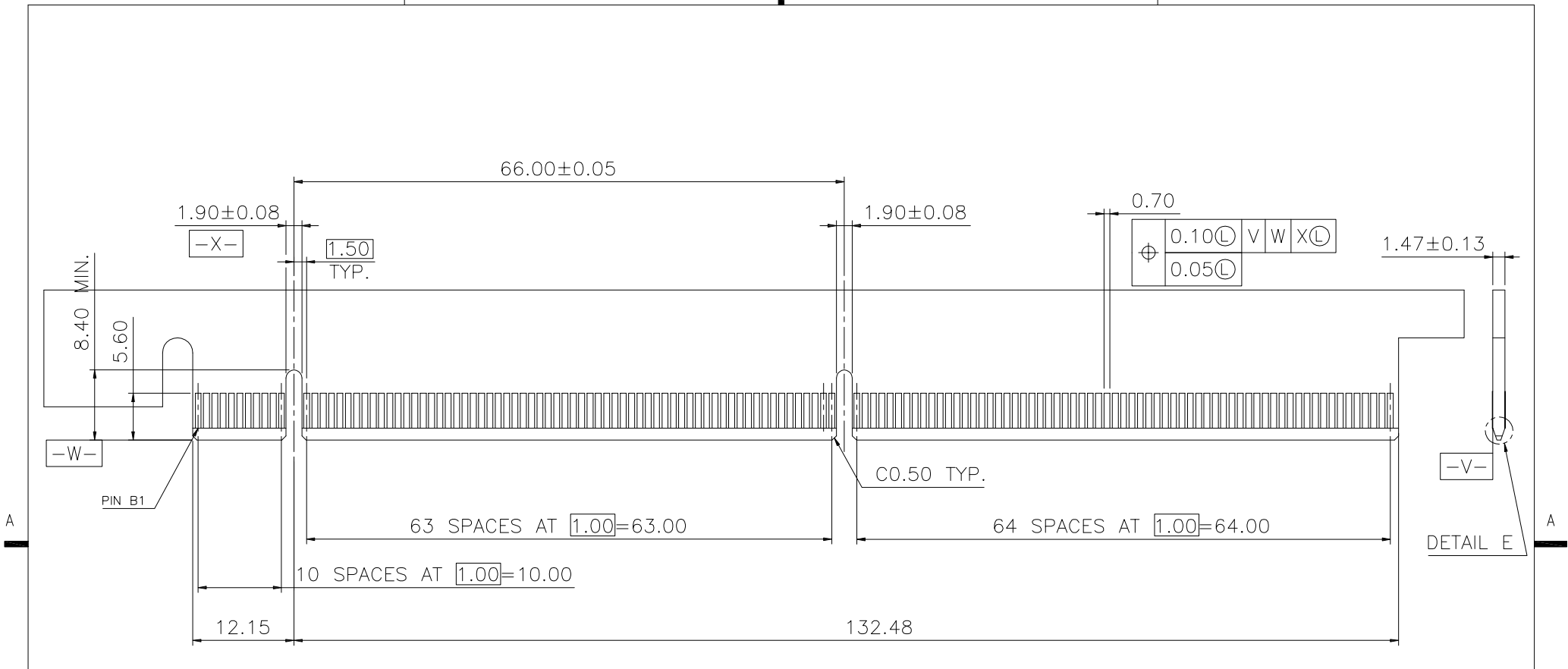

DAUGHTER CARD
PRIMARY (COMPONENT) SIDE

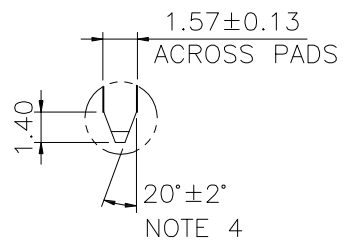

SCALE 2:1
DETAIL E

CONFIDENTIAL

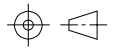
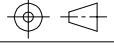
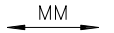
mat'l. code				tolerances unless otherwise specified			CUSTOMER COPY	 www.fciconnect.com			
ltr	ecn no	dr	date	linear	.X ±			projection	title		
					.XX ±				PCI EXPRESS GEN3 		
					.XXX ±				CARD EDGE ASS'Y 280P		
				angles	0° ±2°		  MM scale 1.5:1	product family		code	
				dr	STONE LI	05/27/15		EDGE CARD			TWN
				enr	STONE LI	05/27/15		size dwg no		sheet	
				chr	/	/		A4 10027747		3 of 4	
				appd	PM ZHENG	05/27/15					
sheet index		revision sheet									

cage code
22526

NOTES:

1.MATERIAL:

HOUSING: HIGH TEMPERATURE NYLON, GLASS FILLED UL94V-0 RATED. SUITABLE FOR REFLOW SOLDERING.
 TERMINAL: COPPER ALLOY
 PLATING: 50u" NICKEL UNDERPLATE ALL OVER
 CONTACT AREA PLATING - SEE PRODUCT NUMBER CODE
 SOLDER TAIL: TIN OR TIN/LEAD (90/10) - SEE PRODUCT NUMBER CODE 100u" MIN. OVER 50u" NICKEL
 METAL BOARD LOCKS: COPPER ALLOY
 FINISH: 100u" TIN OR TIN/LEAD (90/10) OVER 50u" NICKEL UNDERPLATE SEE PRODUCT NUMBER CODE

2.PRODUCT SPECIFICATION: GS-12-233

③THE HORIZONTAL AXIS FOR THE HOLE PATTERN IS ESTABLISHED BY A LINE THROUGH THE CENTER OF THE TWO Ø2.35 HOLES. THE VERTICAL AXIS IS 90° TO THE HORIZONTAL AXIS, THROUGH THE CENTER OF DATUM Z.

④CHAMFER EDGES MUST BE FREE OF CUTTING BURRS.

5.RoHS COMPATIBLE PRODUCT SPECIFICATIONS

- a - PLATING:
 - "LF" MEANS THE PRODUCT IS LEAD-FREE, 2um MINIMUM MATTE TIN OVER 1.27um MINIMUM NICKEL UNDERPLATE.
- b - MANUFACTURING PROCESS COMPATIBILITY
 - THE HOUSING WILL WITHSTAND EXPOSURE TO 260°C±5°C SOLDER BATH TEMPERATURE FOR 5 SECONDS IN A WAVE SOLDER APPLICATION WITH A 1.6mm MIN THICK CIRCUIT BOARD.

PRODUCT NUMBER CODE

10027747 -x x x x x □ □

HOUSING COLOR OPTIONS

1-BLACK

PEGS OPTIONS

1-METAL BOARD LOCKS

TERMINAL PLATING OPTIONS

- 0-50u" Ni UNDERPLATE
30u" Au CONTACT AREA
100u" TIN TAIL AREA ----- COMPATIBLE RoHS
- 1-50u" Ni UNDERPLATE
15u" Au CONTACT AREA
100u" TIN TAIL AREA ----- COMPATIBLE RoHS
- 2-50u" Ni UNDERPLATE
GOLD FLASH CONTACT AREA
100u" TIN TAIL AREA ----- COMPATIBLE RoHS
- 3-50u" Ni UNDERPLATE
30u" Au CONTACT AREA
100u" TIN/LEAD TAIL AREA ----- INCOMPLIANT RoHS
- 4-50u" Ni UNDERPLATE
15u" Au CONTACT AREA
100u" TIN/LEAD TAIL AREA ----- INCOMPLIANT RoHS
- 5-50u" Ni UNDERPLATE
GOLD FLASH CONTACT AREA
100u" TIN/LEAD TAIL AREA ----- INCOMPLIANT RoHS

LEAD FREE OPTION

LEAVE BLANK FOR TERMINAL PLATING 3.4.5 "LF" FOR TERMINAL PLATING OPTION 0.1.2

PACKAGING OPTIONS

T-TRAY PACKAGING

RESERVED



0

TAIL LENGTH OPTIONS

	TAIL LENGTH	PCB THICKNESS
1	3.10 ^{+0.25} / _{-0.13}	2.36±0.10

CONFIDENTIAL

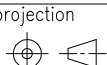
- 0-50u" Ni UNDERPLATE
30u" Au CONTACT AREA
100u" TIN TAIL AREA ----- COMPATIBLE RoHS
- 1-50u" Ni UNDERPLATE
15u" Au CONTACT AREA
100u" TIN TAIL AREA ----- COMPATIBLE RoHS
- 2-50u" Ni UNDERPLATE
GOLD FLASH CONTACT AREA
100u" TIN TAIL AREA ----- COMPATIBLE RoHS
- 3-50u" Ni UNDERPLATE
30u" Au CONTACT AREA
100u" TIN/LEAD TAIL AREA ----- INCOMPLIANT RoHS
- 4-50u" Ni UNDERPLATE
15u" Au CONTACT AREA
100u" TIN/LEAD TAIL AREA ----- INCOMPLIANT RoHS
- 5-50u" Ni UNDERPLATE
GOLD FLASH CONTACT AREA
100u" TIN/LEAD TAIL AREA ----- INCOMPLIANT RoHS

mat'l. code				tolerances unless otherwise specified			CUSTOMER COPY		 www.fciconnect.com	
ltr	ecn no	dr	date	linear	.X ±	projection		title		
					.XX ±			PCI EXPRESS GEN3 		
					.XXX ±			CARD EDGE ASS'Y 280P		
				angles	0° ±2°			product family	EDGE CARD	code
				dr	STONE LI 05/27/15	MM		size	dwg no	TWN
				enrg	STONE LI 05/27/15	1:1	A4	10027747		sheet
				chr	/ /					4 of 4
				appd	PM ZHENG 05/27/15					
sheet index	revision sheet									

cage code 22526