

PRODUCT NO.
10027747-X1XXXX

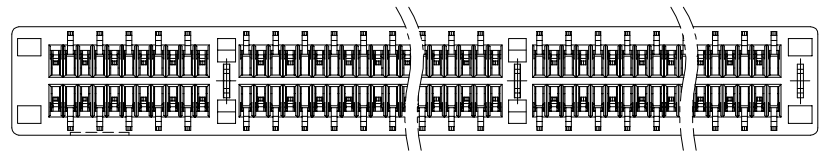
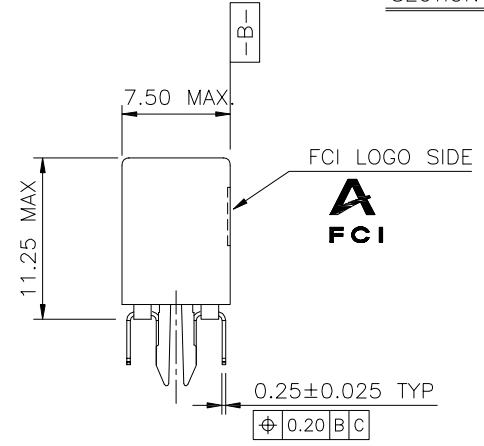
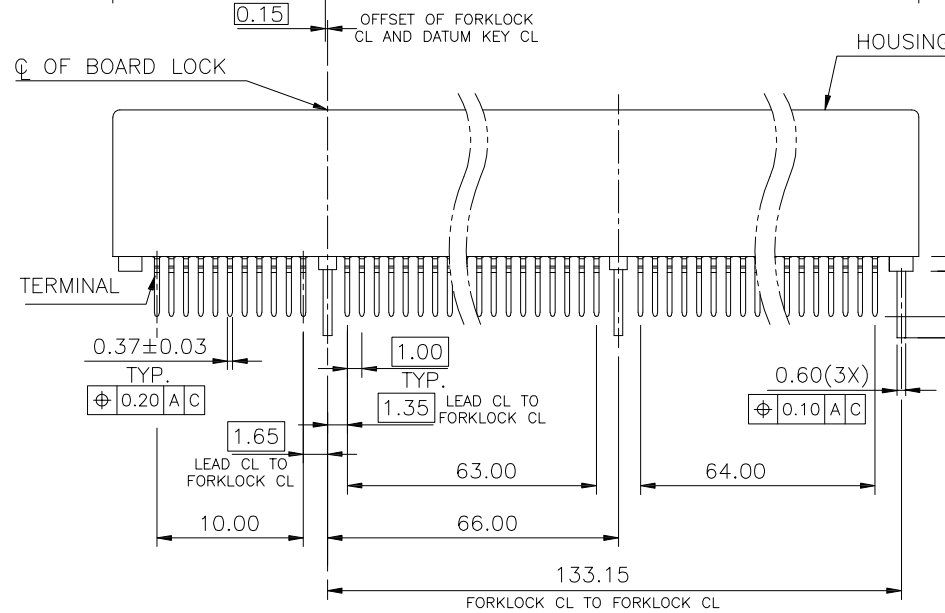
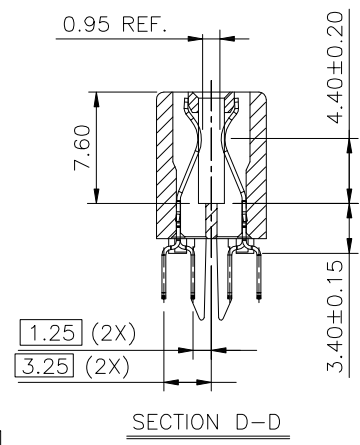
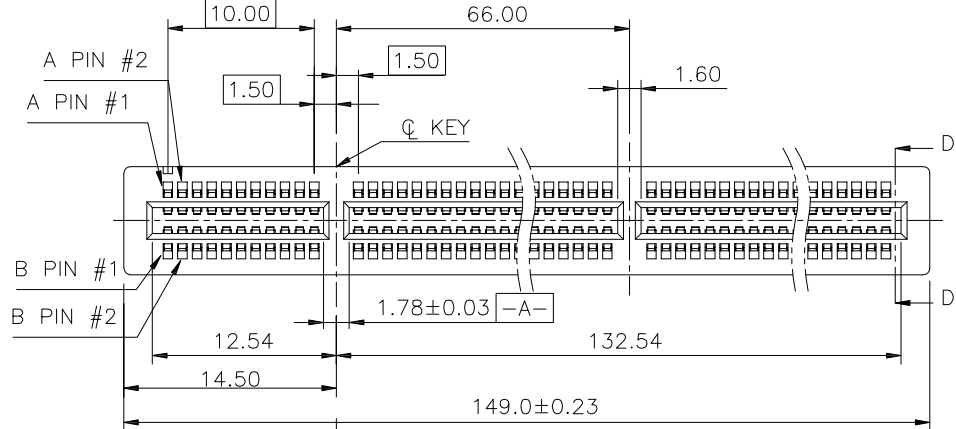

CONFIDENTIAL

mat'l. code				tolerances unless otherwise specified				CUSTOMER COPY		FCI www.fciconnect.com		
ltr	ecn no	dr	date	linear	.X ± 0.30		projection	title	PCI EXPRESS GEN3 CARD EDGE ASSY 280P			
A	T04-0386	M W	10/07/04		.XX ± 0.20							
B	T04-0427	M W	12/10/04		.XXX ± 0.10							
C	T05-0010	M W	01/11/05	angles	0° ± 2°		MM	product family	EDGE CARD		code	
D	ELX-DG-21161-1	S T	05/27/15	dr	STONE LI	05/27/15			size	dwg no		TWN
-	-	-	-	enrg	STONE LI	05/27/15			scale	10027747		sheet
sheet index				revision	D D D D		2:1	A4			1 of 4	
				sheet	1 2 3 4							

cage code
22526

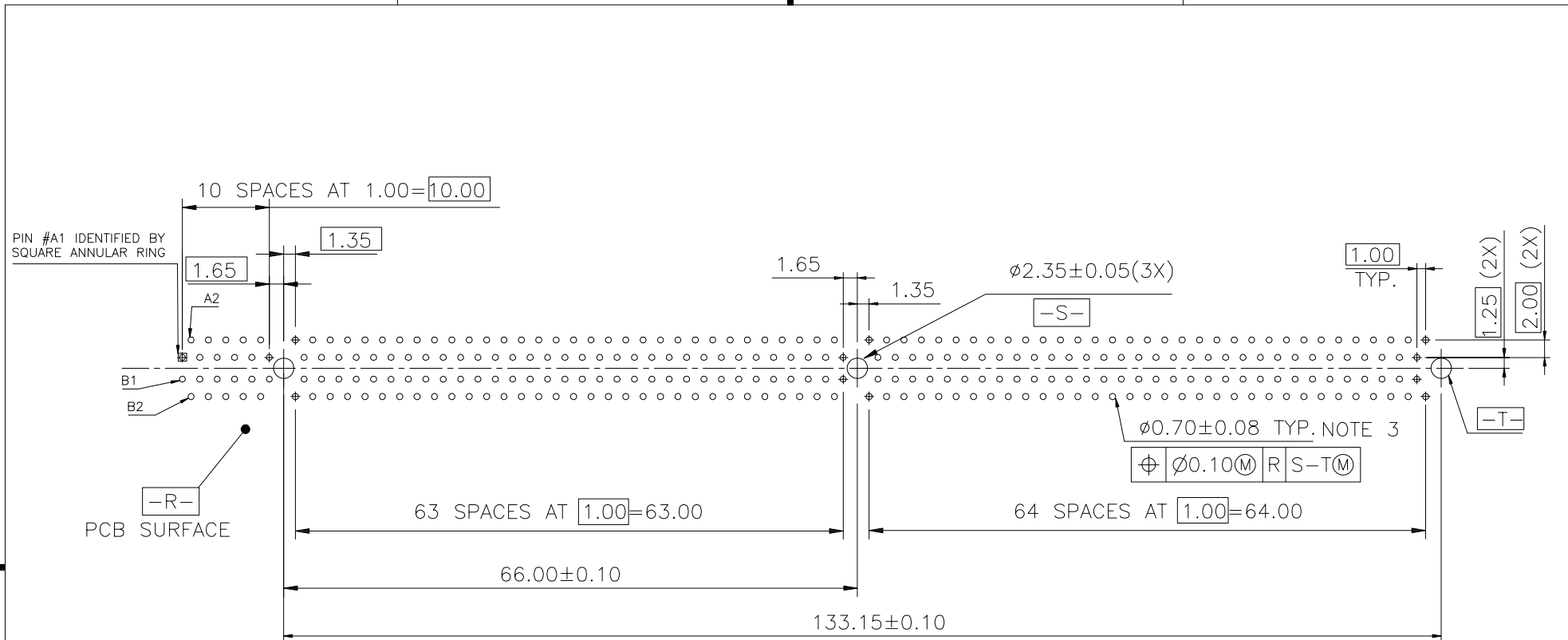

MOTHER BOARD FOOTPRINT PATTERN
CONNECTOR SIDE SHOWN

CONFIDENTIAL

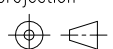
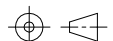
mat'l. code				tolerances unless otherwise specified		CUSTOMER COPY	 www.fciconnect.com		
ltr	ecn no	dr	date	linear	.X ±			projection	title PCI EXPRESS GEN3  CARD EDGE ASS'Y 280P
					.XX ±	 MM	product family	EDGE CARD	
				angles	.XXX ±		scale	size	dwg no
				dr	0° ±2°	1.5:1		A4	10027747
				enr					
				chr					
				appd					
sheet index		revision sheet							

cage code
22526

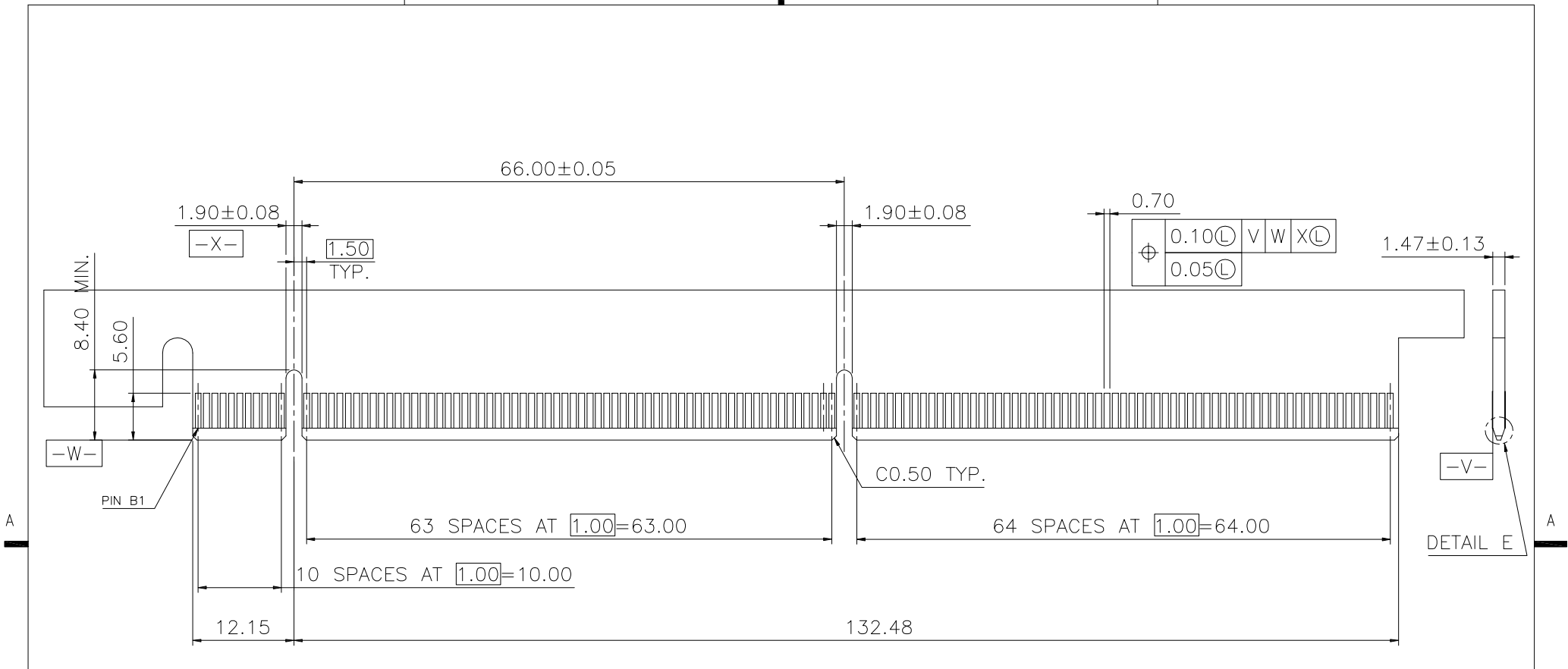

DAUGHTER CARD
PRIMARY (COMPONENT) SIDE

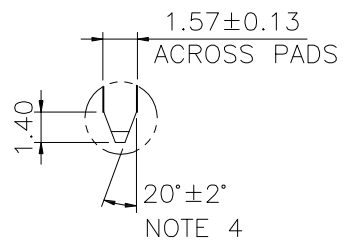

SCALE 2:1
DETAIL E

CONFIDENTIAL

mat'l. code				tolerances unless otherwise specified		CUSTOMER COPY	 www.fciconnect.com			
ltr	ecn no	dr	date	linear	.X ±		projection	title		
					.XX ±			PCI EXPRESS GEN3		 CARD EDGE ASS'Y 280P
					.XXX ±			product family		
				angles	0° ±2°	 MM	size		code	
				dr	STONE LI		05/27/15	10027747		TWN
				enr	STONE LI		05/27/15	A4		sheet
				chr	/		/	scale		3 of 4
				appd	PM ZHENG	05/27/15	1.5:1			
sheet index		revision sheet						cage code		
								22526		

NOTES:

1.MATERIAL:

HOUSING: HIGH TEMPERATURE NYLON, GLASS FILLED UL94V-0 RATED. SUITABLE FOR REFLOW SOLDERING.
 TERMINAL: COPPER ALLOY
 PLATING: 50u" NICKEL UNDERPLATE ALL OVER
 CONTACT AREA PLATING - SEE PRODUCT NUMBER CODE
 SOLDER TAIL: TIN OR TIN/LEAD (90/10) - SEE PRODUCT NUMBER CODE 100u" MIN. OVER 50u" NICKEL
 METAL BOARD LOCKS: COPPER ALLOY
 FINISH: 100u" TIN OR TIN/LEAD (90/10) OVER 50u" NICKEL UNDERPLATE SEE PRODUCT NUMBER CODE

2.PRODUCT SPECIFICATION: GS-12-233

③THE HORIZONTAL AXIS FOR THE HOLE PATTERN IS ESTABLISHED BY A LINE THROUGH THE CENTER OF THE TWO ϕ 2.35 HOLES. THE VERTICAL AXIS IS 90° TO THE HORIZONTAL AXIS, THROUGH THE CENTER OF DATUM Z.

④CHAMFER EDGES MUST BE FREE OF CUTTING BURRS.

5.RoHS COMPATIBLE PRODUCT SPECIFICATIONS

- a - PLATING:
 - "LF" MEANS THE PRODUCT IS LEAD-FREE, 2um MINIMUM MATTE TIN OVER 1.27um MINIMUM NICKEL UNDERPLATE.
- b - MANUFACTURING PROCESS COMPATIBILITY
 - THE HOUSING WILL WITHSTAND EXPOSURE TO 260°C±5°C SOLDER BATH TEMPERATURE FOR 5 SECONDS IN A WAVE SOLDER APPLICATION WITH A 1.6mm MIN THICK CIRCUIT BOARD.

PRODUCT NUMBER CODE

10027747 -x x x x x □ □

HOUSING COLOR OPTIONS

1-BLACK

PEGS OPTIONS

1-METAL BOARD LOCKS

TERMINAL PLATING OPTIONS

- 0-50u" Ni UNDERPLATE
30u" Au CONTACT AREA
100u" TIN TAIL AREA ----- COMPATIBLE RoHS
- 1-50u" Ni UNDERPLATE
15u" Au CONTACT AREA
100u" TIN TAIL AREA ----- COMPATIBLE RoHS
- 2-50u" Ni UNDERPLATE
GOLD FLASH CONTACT AREA
100u" TIN TAIL AREA ----- COMPATIBLE RoHS
- 3-50u" Ni UNDERPLATE
30u" Au CONTACT AREA
100u" TIN/LEAD TAIL AREA ----- INCOMPLIANT RoHS
- 4-50u" Ni UNDERPLATE
15u" Au CONTACT AREA
100u" TIN/LEAD TAIL AREA ----- INCOMPLIANT RoHS
- 5-50u" Ni UNDERPLATE
GOLD FLASH CONTACT AREA
100u" TIN/LEAD TAIL AREA ----- INCOMPLIANT RoHS

LEAD FREE OPTION

LEAVE BLANK FOR TERMINAL PLATING 3.4.5 "LF" FOR TERMINAL PLATING OPTION 0.1.2

PACKAGING OPTIONS

T-TRAY PACKAGING

RESERVED



0

TAIL LENGTH OPTIONS

	TAIL LENGTH	PCB THICKNESS
1	3.10 \pm 0.25 -0.13	2.36±0.10

CONFIDENTIAL

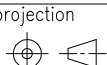
- 0-50u" Ni UNDERPLATE
30u" Au CONTACT AREA
100u" TIN TAIL AREA ----- COMPATIBLE RoHS
- 1-50u" Ni UNDERPLATE
15u" Au CONTACT AREA
100u" TIN TAIL AREA ----- COMPATIBLE RoHS
- 2-50u" Ni UNDERPLATE
GOLD FLASH CONTACT AREA
100u" TIN TAIL AREA ----- COMPATIBLE RoHS
- 3-50u" Ni UNDERPLATE
30u" Au CONTACT AREA
100u" TIN/LEAD TAIL AREA ----- INCOMPLIANT RoHS
- 4-50u" Ni UNDERPLATE
15u" Au CONTACT AREA
100u" TIN/LEAD TAIL AREA ----- INCOMPLIANT RoHS
- 5-50u" Ni UNDERPLATE
GOLD FLASH CONTACT AREA
100u" TIN/LEAD TAIL AREA ----- INCOMPLIANT RoHS

mat'l. code				tolerances unless otherwise specified			CUSTOMER COPY		 www.fciconnect.com		
ltr	ecn no	dr	date	linear	.X ±	projection		title			
					.XX ±			PCI EXPRESS GEN3 			
					.XXX ±			CARD EDGE ASS'Y 280P			
				angles	0° ±2°			product family		EDGE CARD	code
				dr	STONE LI 05/27/15	MM		size		dwg no	TWN
				enrg	STONE LI 05/27/15	scale		A4		10027747	sheet
				chr	/ /	1:1					4 of 4
				appd	PM ZHENG 05/27/15						
sheet index	revision sheet										

cage code 22526